

Item description

Distribution connector *WINSTA*® MIDI 5-pole

The *WINSTA*® MIDI distribution connector rated current 25 A allows assembly of solid and fine-stranded conductors. The pluggable installation connectors with spring pressure connection technology function without screw connections. They allow fast, efficient, error-free installation in a large number of possible uses. The color coding and mechanical coding of the pluggable installation connector ensure error-free installation of the individual components – including protection against mismatching. The pluggable installation connector is protected against ingress by solid objects in accordance with protection type IP20 (When mated: IP2xC (These compact connectors are not designed for use in open, easily accessible areas!)). Pluggable installation connectors with B coding from the *WINSTA*® MIDI line are available in gray, light green, or pink, allowing you to distinguish different circuits, for example for light, pumps or, sun blinds. Customer-specific pole marking is possible in addition. This pluggable installation connector is designed for a load of up to 25 A. As a result, it can also be used for high power loads. The *WINSTA*® MIDI product line allows flexibility for the installation of applications. Through its Push-in CAGE CLAMP® spring pressure connection technology, it achieves error-free, time-saving installation and offers customization for meeting all installation requirements.

Subject to changes. Please also observe the further product documentation!



WINSTA® MIDI solutions for your electrical installation – protected against mismatching and maintenance-free

WINSTA® is the pluggable connection system that is ideally tailored to the strict requirements of electrical installation. It offers error-free installation of cables and components, quickly and reliably. Enjoy the benefits of the pluggable version of our maintenance-free spring pressure connection technology too! Plan your installation with WINSTA® MIDI pluggable installation connectors with locking lever from WAGO.

- pluggable installation connectors with protection against mismatching
- simple circuits
- with B coding for use in process automation, such as lighting technology, for example
- ready to install and use immediately
- quick replacement of defective units during ongoing operation

Data

Notes

Variants:

Other pole markings

Other versions (or variants) can be requested from WAGO Sales or configured at <https://configurator.wago.com/>.

Electrical data

Ratings per IEC/EN

Ratings per	IEC/EN 60664-1
Nominal voltage (III/3)	400 V
Rated impulse voltage (III/3)	6 kV
Rated current	25 A
Note (rated current)	25 A for 3-pole load 20 A for 4- and 5-pole load
Legend (ratings)	(III / 3) ≙ Overvoltage category III / Pollution degree 3

Ratings per UL 1977

Note for the US market

Some versions may also be used for current interruption in accordance with the UL certificate in select applications with currents below 16 A and voltages up to 600 V. For further information, please contact your local sales office.

Rated voltage (UL 1977)	600 V
-------------------------	-------

Subject to changes. Please also observe the further product documentation!

WAGO GmbH & Co. KG

Hansastr. 27

32423 Minden

Phone: +49571 887-0 | Fax: +49571 887-169

Email: info.de@wago.com | Web: www.wago.com

Do you have any questions about our products?

We are always happy to take your call at +49 (571) 887-44222.



Rated current UL 1977

23 A

General

Note on contact resistance

approx. 1 mΩ of contact resistance
approx. 0.25 mΩ contact transition plug/socket

Connection data

Total number of potentials

5

Connection 1

Pole number

5

Physical data

Pin spacing

10 mm / 0.394 inches

Width

50 mm / 1.969 inches

Height

36.7 mm / 1.445 inches

Depth

46 mm / 1.811 inches

Mechanical Data

Application

Control technology

Coding

B

Marking

1 2 3 4 5

Potential marking

1 2 3 4 5

Mating force of a plug-in connection

approx. 20 ... 70 N (depending on pole number)

Retention force of a plug-in connection

When locked: > 80 N

Unmating force of a plug-in connection

Unlocked: approx. 20 ... 70 N (depending on pole number)

Number of mating cycles

200, without resistive load

Type of distribution box

Distribution connector, 3-way

Protection type

IP20; When mated: IP2xC (These compact connectors are not designed for use in open, easily accessible areas!)

Plug-in connection

Contact type (pluggable connector)

Socket/plug

Mismating protection

Yes

Note on mismating protection

All WINSTA[®] components are 100% protected against mismating when:

Subject to changes. Please also observe the further product documentation!

WAGO GmbH & Co. KG

Hansastr. 27

32423 Minden

Phone: +49571 887-0 | Fax: +49571 887-169

Email: info.de@wago.com | Web: www.wago.com

Do you have any questions about our products?

We are always happy to take your call at +49 (571) 887-44222.



- a.) plugging different numbers of poles
- b.) plugging while rotated 180
- c.) plugging while laterally staggered
- d.) plugging one pole

Locking lever	yes
Locking of plug-in connection	locking lever
Note on locking system	All connectors for mounted installations (snap-in versions for lighting fixtures or devices, all types of PCB and distribution connectors) are factory-equipped with locking levers to ensure plugs and sockets are securely locked. Additional locking levers are only required for flying leads (plug/socket).
Number of locking levers	4

Material Data

Note (material data)	Information on material specifications can be found here
Color	gray
Insulation material	Polyamide (PA66)
Flammability class per UL94	V0
Contact material	Copper or copper alloy; surface-treated
Contact plating	Tin
Fire load	0.868 MJ
Weight	44.3 g

Environmental requirements

Processing temperature	-5 ... +40 °C
Continuous operating temperature	-35 ... +85 °C
Note on continuous operating temperature	Insulating parts for temperatures \leq 105 °C

Commercial data

Product Group	20 (Winsta)
eCl@ss 10.0	27-44-06-03
eCl@ss 9.0	27-44-06-03
ETIM 8.0	EC002567
ETIM 7.0	EC002567
PU (SPU)	25 pcs
Packaging type	box
Country of origin	DE

Subject to changes. Please also observe the further product documentation!

WAGO GmbH & Co. KG
 Hansastr. 27
 32423 Minden
 Phone: +49571 887-0 | Fax: +49571 887-169
 Email: info.de@wago.com | Web: www.wago.com

Do you have any questions about our products?
 We are always happy to take your call at +49 (571) 887-44222.

GTIN	4050821687689
Customs tariff number	85366990990

Environmental Product Compliance





RoHS Compliance Status	Compliant, No Exemption
------------------------	-------------------------

Approvals / Certificates

General approvals



Logo	Approval	Additional Approval Text	Certificate name
	cURus Underwriters Laboratories Inc.	UL 1977	E45171

Counterpart

	Item no. 770-245 Socket; 5-pole; Cod. B; 4,00 mm ² ; gray	www.wago.com/770-245
	Item no. 770-255 Plug; 5-pole; Cod. B; 4,00 mm ² ; gray	www.wago.com/770-255
	Item no. 771-9995/005-103 pre-assembled interconnecting cable; Eca; Socket/plug; 5-pole; Cod. B; 1 m; 1,00 mm ² ; gray	www.wago.com/771-9995/005-103
	Item no. 771-9995/105-103 pre-assembled connecting cable; Eca; Socket/open-ended; 5-pole; Cod. B; 1 m; 1,00 mm ² ; gray	www.wago.com/771-9995/105-103
	Item no. 771-9995/205-103 pre-assembled connecting cable; Eca; Plug/open-ended; 5-pole; Cod. B; 1 m; 1,00 mm ² ; gray	www.wago.com/771-9995/205-103

Optional accessories

Cover

	Item no.: 770-360 Lockout cap; for plugs; 5-pole; separable; yellow	www.wago.com/770-360
	Item no.: 770-201 Lockout cap; 12-pole, separable; for sockets; Plastic; black	www.wago.com/770-201

Subject to changes. Please also observe the further product documentation!

Item no.: 770-221

Lockout cap; 12-pole, separable; for sockets; Plastic; white

www.wago.com/770-221

Mounting

Mounting accessories



Item no.: 770-625

Mounting plate; 5-pole; for distribution connectors; Plastic; black

www.wago.com/770-625



Item no.: 770-675

Mounting plate; 5-pole; for distribution connectors; Plastic; white

www.wago.com/770-675

Downloads

Documentation

Bid Text

770-1744 X81 - Datei	2019 Feb 19	xml 2.8 kB	Download
770-1744 doc - Datei	2015 Mar 12	doc 23.6 kB	Download

CAD/CAE-Data

CAE data

WSCAD Universe 770-1744	URL	Download
-------------------------	-----	----------

Environmental Product Compliance

Compliance Search

Environmental Product Compliance 770-1744 3-way distribution connector; 5-pole; Cod. B; 1 input; 3 outputs; gray	URL	Download
---	-----	----------

Installation Notes

Installation

Subject to changes. Please also observe the further product documentation!

WAGO GmbH & Co. KG
Hansastr. 27
32423 Minden
Phone: +49571 887-0 | Fax: +49571 887-169
Email: info.de@wago.com | Web: www.wago.com

Do you have any questions about our products?
We are always happy to take your call at +49 (571) 887-44222.

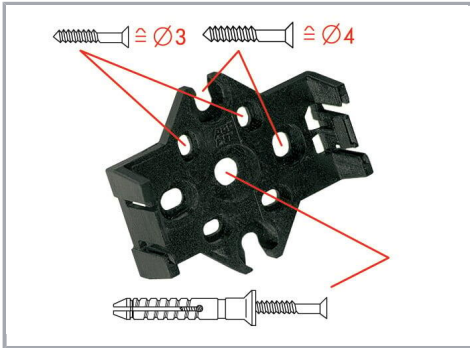

Mounting plates can be secured using commercially available screws or nail-drive anchors.



The distribution connectors snap together when attached to the mounting plate.



To release the distribution connector, unlock the latch using a screwdriver.

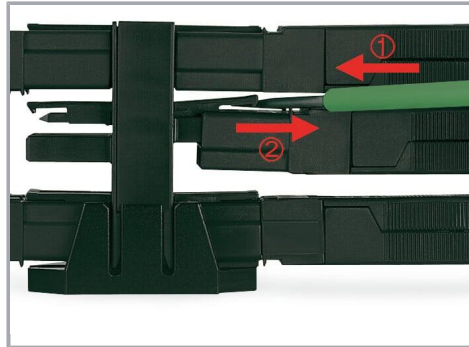

All distribution connector connections are locked and protected against accidental disconnection directly after mating. Locking of any connection is released using a screwdriver, even if all connections are used.

Product family

WINSTA® MIDI

[Show all products from the family](#)

Subject to changes. Please also observe the further product documentation!