

STM32

clicker

A compact starter kit with your favorite microcontroller and a socket for click™ add-on boards. New ideas are just a click away.



TO OUR VALUED CUSTOMERS

I want to express my thanks to you for being interested in our products and for having confidence in MikroElektronika.

The primary aim of our company is to design and produce high quality electronic products and to constantly improve the performance thereof in order to better suit your needs.

A white, handwritten signature in cursive script, appearing to read 'N. Matic', is positioned on the right side of the page.

Nebojsa Matic
General Manager

Table of contents

1. What is STM32 M4 clicker?	4	step 4 - Uploading .HEX file	12
2. Power supply	6	step 5 - Finish upload	13
3. STM32F415RG microcontroller	8	Programming with mikroProg™ programmer	14
Key microcontroller features	8	mikroProg Suite™ for ARM® software	15
4. Programming the microcontroller	9	Programming with ST-LINK V2 programmer	16
Programming with mikroBootloader	10	5. Buttons and LEDs	18
step 1 - Connecting STM32 M4 clicker	10	6. RTC battery	20
step 2 - Browsing for .HEX file	11	7. click™ boards are plug and play!	22
step 3 - Selecting .HEX file	11	8. Dimensions	24

1. What is STM32 M4 clicker?

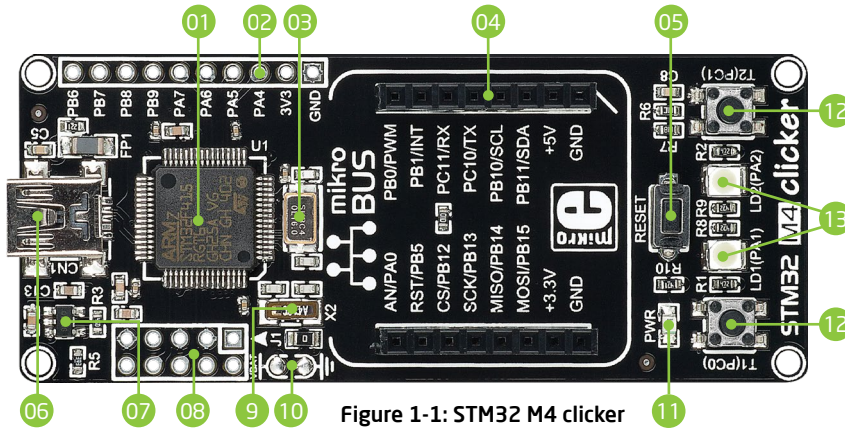


Figure 1-1: STM32 M4 clicker

- 01 64-pin STM32F415RG MCU
- 02 Connection pads
- 03 16 MHz crystal oscillator
- 04 mikroBUS™ socket
- 05 RESET button
- 06 USB Mini-B connector
- 07 3.3V Voltage regulator
- 08 JTAG Programmer connector
- 09 32.768 KHz crystal oscillator
- 10 RTC battery pads
- 11 Power indication LED
- 12 Additional buttons
- 13 Additional LEDs

STM32 M4 clicker is an amazingly compact starter development kit which brings the innovative mikroBUS™ socket to your favorite microcontroller. It features **STM32F415RG**, a 32-bit ARM® Cortex®-M4 microcontroller, two indication LEDs, two general purpose buttons, a reset button, a USB Mini-B connector and a single mikroBUS™ socket. A JTAG connector and pads for interfacing with external electronics are provided as well. The mikroBUS™ connector consists of two 1x8 female headers with **SPI**, **I²C**, **UART**, **RST**, **PWM**, **Analog** and **Interrupt** lines as well as **3.3V**, **5V** and **GND** power lines. **STM32 M4 clicker** board can be powered over a USB cable.

2. Power supply

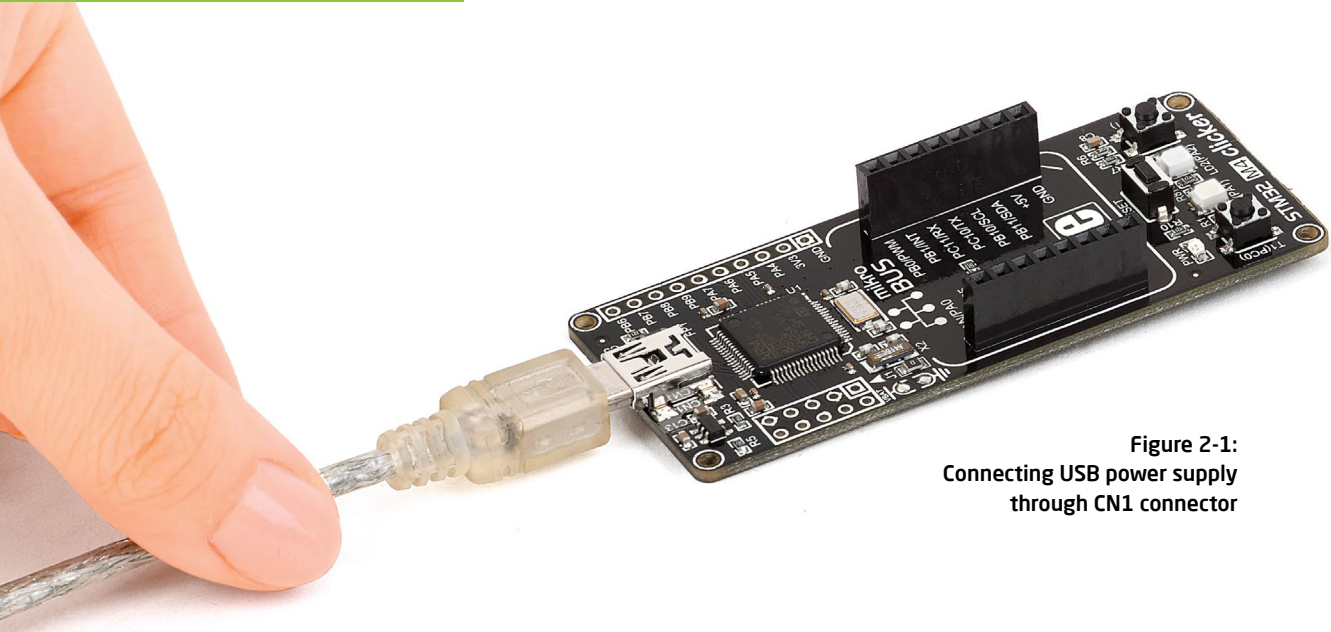


Figure 2-1:
Connecting USB power supply
through CN1 connector

When the board is powered up the power indication LED will be automatically turned on. The USB connection can provide up to 500mA of current which is more than enough for the operation of all on-board and additional modules.

3.3V VOLTAGE REGULATOR

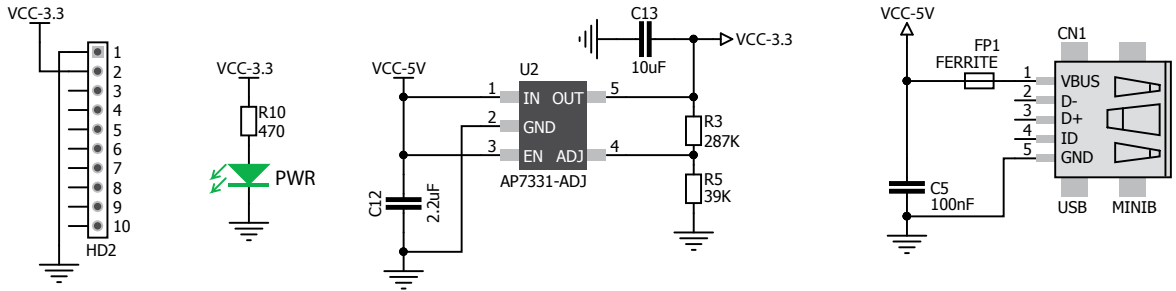


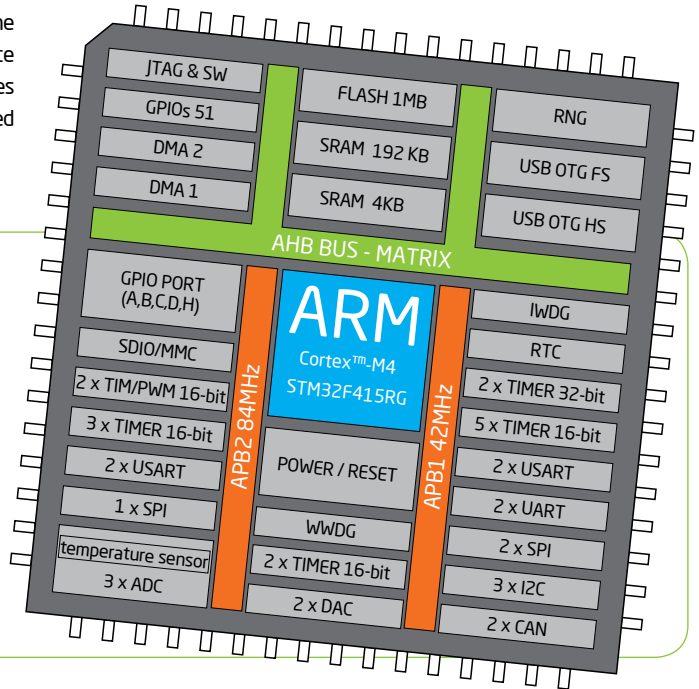
Figure 2-2: Power supply schematic

3. STM32F415RG microcontroller

The STM32 M4 clicker development tool comes with the **STM32F415RG** microcontroller. This 32-bit high performance microcontroller is rich with on-chip peripherals and features 1024KB of Flash and 192KB of SRAM. It has integrated full speed USB 2.0. support.

Key microcontroller features

- Up to **168 MHz** operation
- 32-bit ARM® Cortex®-M4 architecture
- 1024KB of Flash memory
- 192KB SRAM
- 64 pin LQFP
- 3x 16 ch, 12-bit ADC
- USB 2.0, UART, RTC, SPI, I²C, etc.



4. Programming the microcontroller

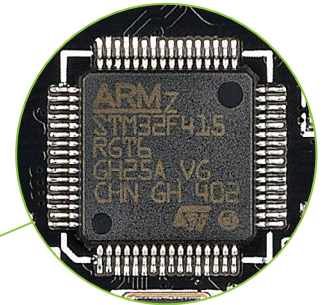
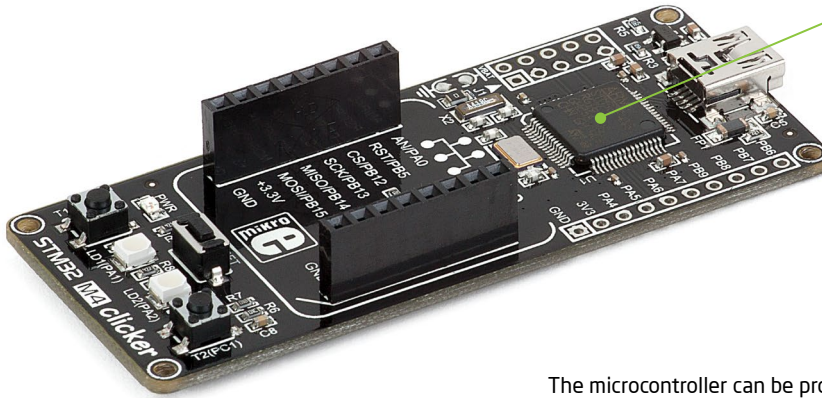


Figure 4-1:
STM32F415RG
microcontroller

The microcontroller can be programmed in two ways:

- 01 Using USB HID mikroBootloader,
- 02 Using external mikroProg™ for STM32 programmer.

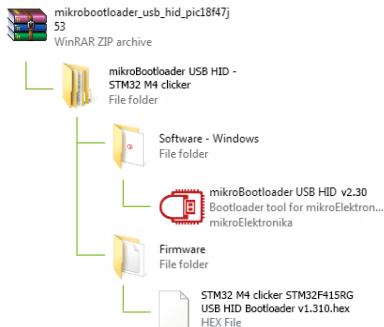
Programming with mikroBootloader

You can program the microcontroller with a bootloader which is preprogrammed by default. To transfer .hex file from a PC to MCU you need bootloader software (**mikroBootloader USB HID**) which can be downloaded from:



www.mikroe.com/downloads/get/2144/mikrobootloader_usb_hid_STM32F415RG.zip

After the mikroBootloader software is downloaded, unzip it to desired location and start it.



step 1 - Connecting STM32 M4 clicker



Figure 4-2: USB HID mikroBootloader window

- 01 To start, connect the USB cable, or if already connected press the **Reset** button on your STM32 M4 clicker. Click the **Connect** button within 5s to enter the bootloader mode, otherwise existing microcontroller program will execute.

step 2 - Browsing for .HEX file



Figure 4-3: Browse for HEX

- 01 Click the **Browse for HEX** button and from a pop-up window (**Figure 3.4**) choose the .HEX file which will be uploaded to MCU memory.

step 3 - Selecting .HEX file

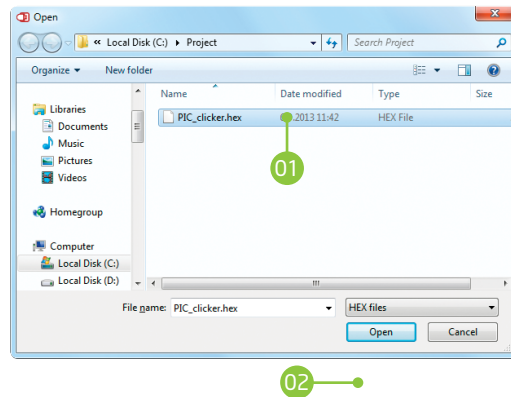


Figure 4-4: Selecting HEX

- 01 Select .HEX file using open dialog window.
- 02 Click the **Open** button.

step 4 - Uploading .HEX file



Figure 4-5: Begin uploading

- 01 To start .HEX file bootloading click the **Begin uploading** button.



Figure 4-6: Progress bar

- 01 Progress bar enables you to monitor .HEX file uploading.

step 5 - Finish upload



Figure 4-7: Restarting MCU

- 01 Click **OK** button after the uploading process is finished.
- 02 Press **Reset** button on STM32 M4 clicker board and wait for 5 seconds. Your program will run automatically.



Figure 4-8: mikroBootloader ready for next job

Programming with mikroProg™ programmer

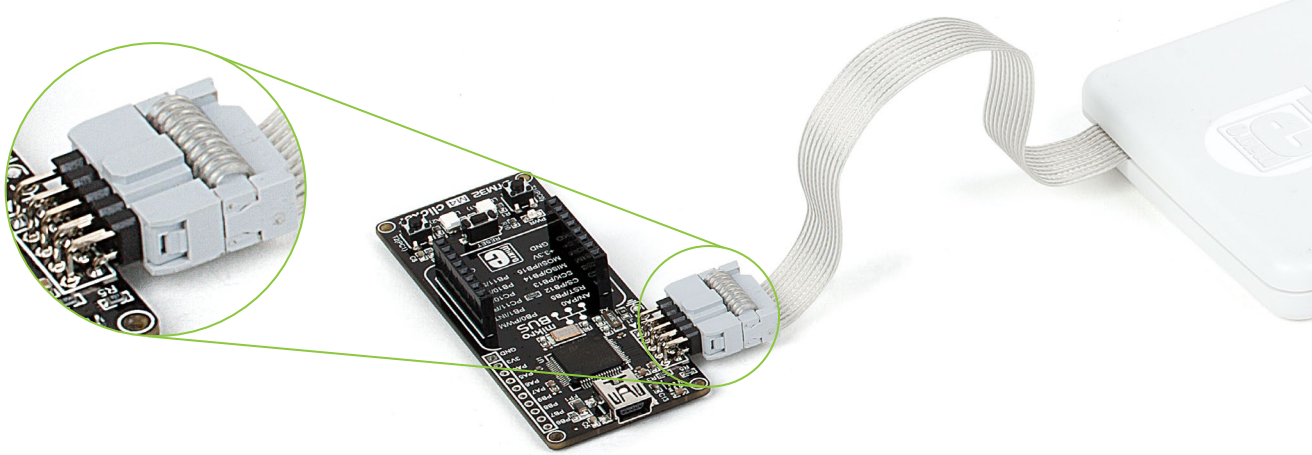


Figure 4-9: mikroProg™ connector

The microcontroller can be programmed with external **mikroProg™ for STM32 programmer** and **mikroProg Suite™ for ARM® software**. The external programmer is connected to the development system via 2x5 JTAG connector soldered on the CN2 connector pads, **Figure 4-9. mikroProg™** is a fast USB 2.0 programmer with hardware debugger support. It supports STM32 M3 and M4 devices from STMicroelectronics. Outstanding performance, easy operation and elegant design are its key features.

mikroProg Suite™ for ARM® software

On-board mikroProg™ programmer requires special programming software called mikroProg Suite™ for ARM®. This software is used for programming of all supported microcontroller families with ARM® Cortex™-M3 and Cortex™-M4 cores. The software has an intuitive interface and SingleClick™ programming technology. To begin, first locate the installation archive on the link below:



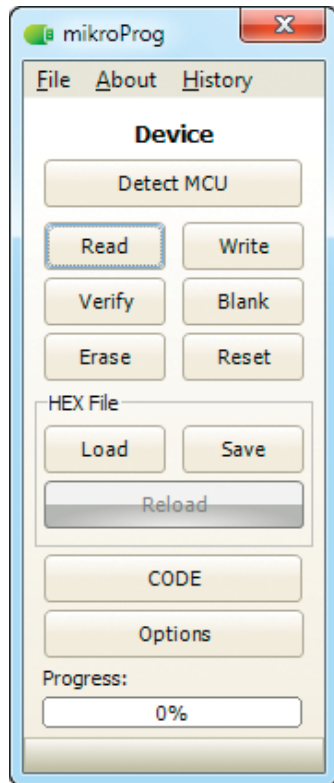
http://www.mikroe.com/downloads/get/1809/mikroprog_suite_for_arm.zip

After downloading, extract the package and double click the executable setup file, to start installation.

Quick guide

- 01 Click the **Detect MCU** button in order to recognize the device ID.
- 02 Click the **Read** button to read the entire microcontroller memory. You can click the **Save** button to save it to the target HEX file.
- 03 If you want to write the HEX file into the microcontroller, first make sure to load the target HEX file using the **Load** button. Then click the **Write** button to begin programming.
- 04 Click the **Erase** button to clear the microcontroller memory.

Figure 4-10:
mikroProg Suite™
for ARM® window

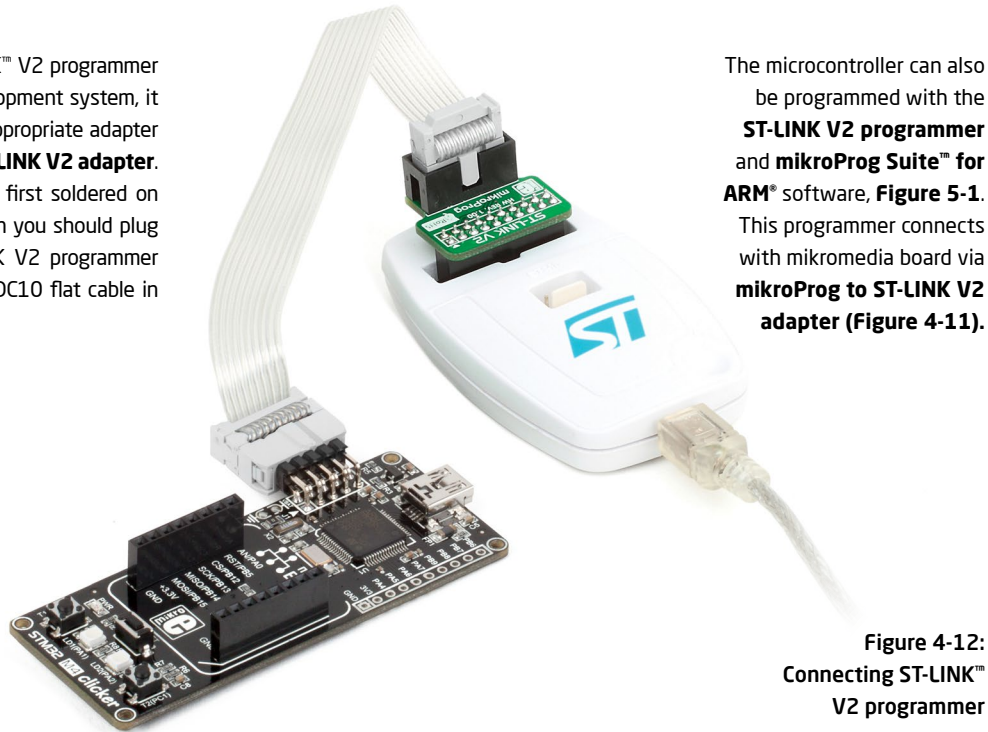


Programming with ST-LINK V2 programmer

In order to adjust the ST-LINK™ V2 programmer to be connected to the development system, it is necessary to provide the appropriate adapter such as the **mikroProg to ST-LINK V2 adapter**. 2x5 male headers should be first soldered on the CN2 connector pads. Then you should plug the adapter into the ST-LINK V2 programmer (2x10 header), and plug an IDC10 flat cable in headers, **Figure 4-12**.

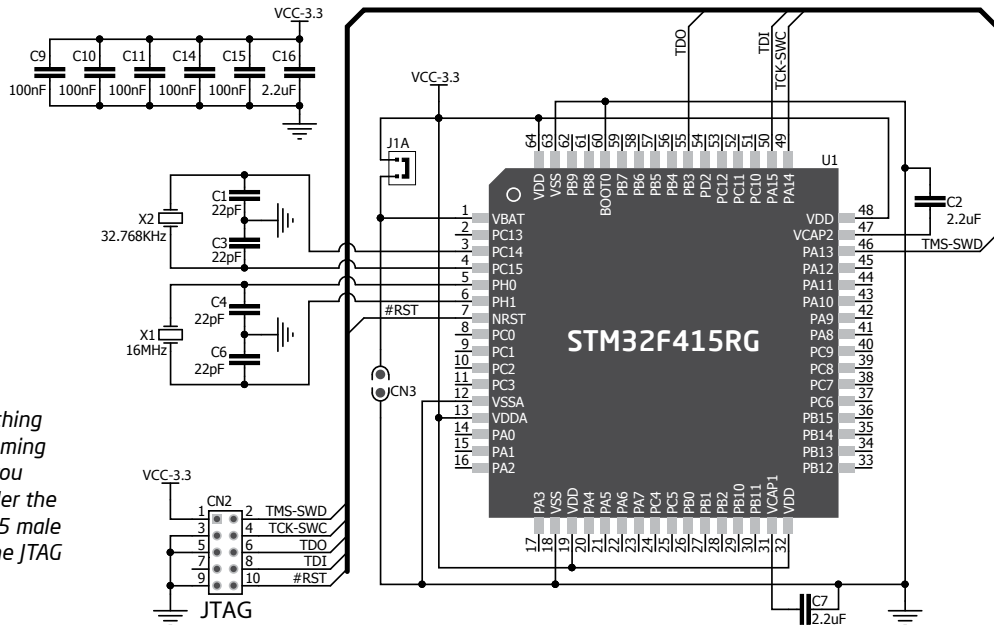


Figure 4-11:
mikroProg™ to
ST-LINK™ V2 adapter



The microcontroller can also be programmed with the **ST-LINK V2 programmer** and **mikroProg Suite™ for ARM®** software, **Figure 5-1**. This programmer connects with mikroMedia board via **mikroProg to ST-LINK V2 adapter** (**Figure 4-11**).

Figure 4-12:
Connecting ST-LINK™
V2 programmer



NOTE Before attaching the programming connector, you have to solder the provided 2x5 male header to the JTAG (CN2) pads.

Figure 4-13: mikroProg™ connection schematic

5. Buttons and LEDs

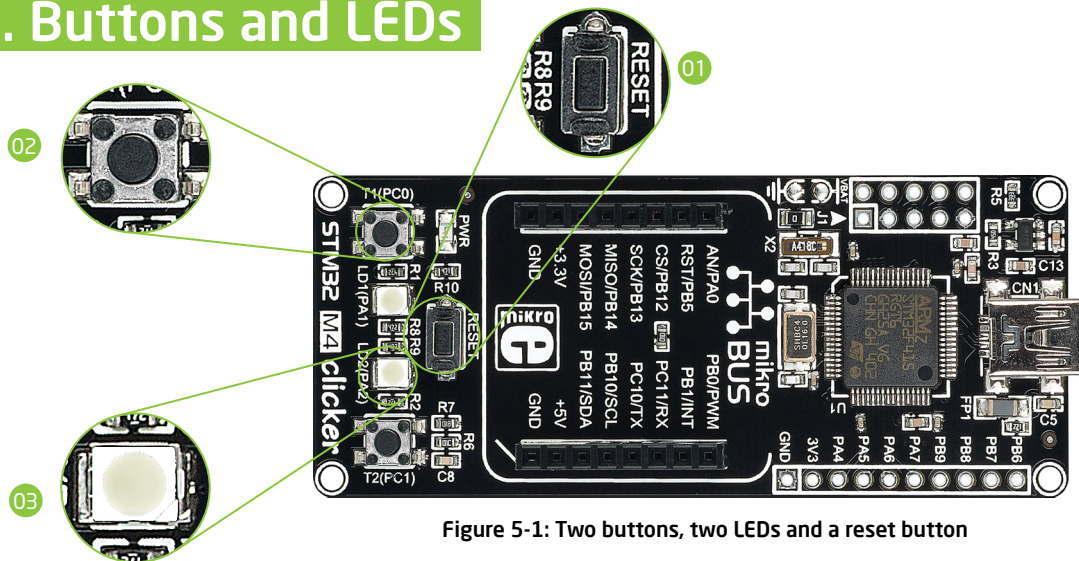


Figure 5-1: Two buttons, two LEDs and a reset button

The board also contains a **01 reset button** and a pair of **02 buttons** and **03 LEDs**. Each of these additional peripherals are located in the bottom area of the board. **Reset button** is used to manually reset the microcontroller. Pressing the reset button will generate a low voltage level on microcontroller's reset pin. **LEDs** can be used for visual indication of the logic state on two pins (**PA1 and PA2**). An active LED indicates that a logic high (1) is present on the pin. Pressing any of these **buttons** can change the logic state of the microcontroller pins (**PC0 and PC1**) from logic high (1) to logic low (0).

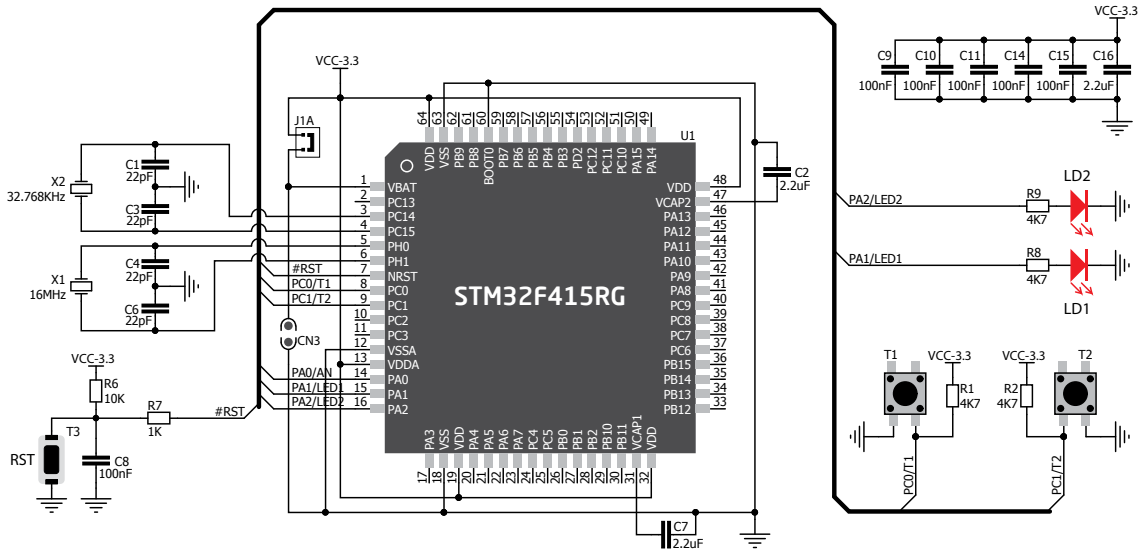
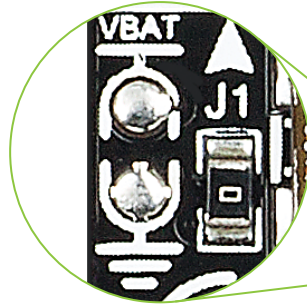


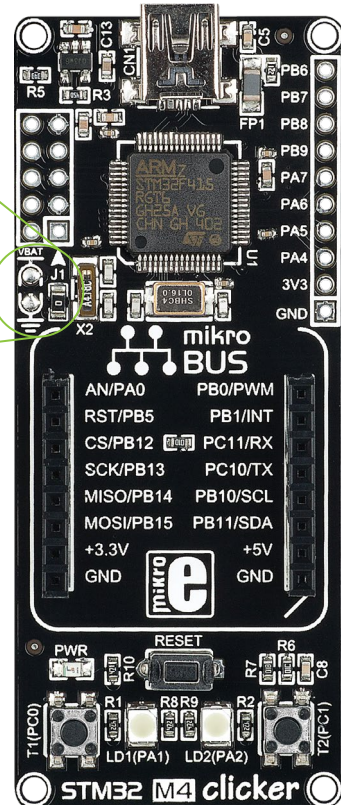
Figure 5-2: Other modules connection schematic

6. RTC battery



STM32 M4 clicker features RTC battery pads for powering microcontroller's internal RTC module. Battery is used as an alternative source of power, so the RTC module can keep track of time while primary source of power is OFF or unavailable. In order to use this option it is necessary to connect (solder) external battery (type **CR2032**; voltage range from **1.65 to 3.6 V**) and unsolder jumper **J1**, **Figure 6-1**. Make sure that orientation of the battery is correct (plus on **VBAT** and minus on **GND** pad), otherwise it won't work properly.

Figure 6-1:
battery pads
and jumper J1



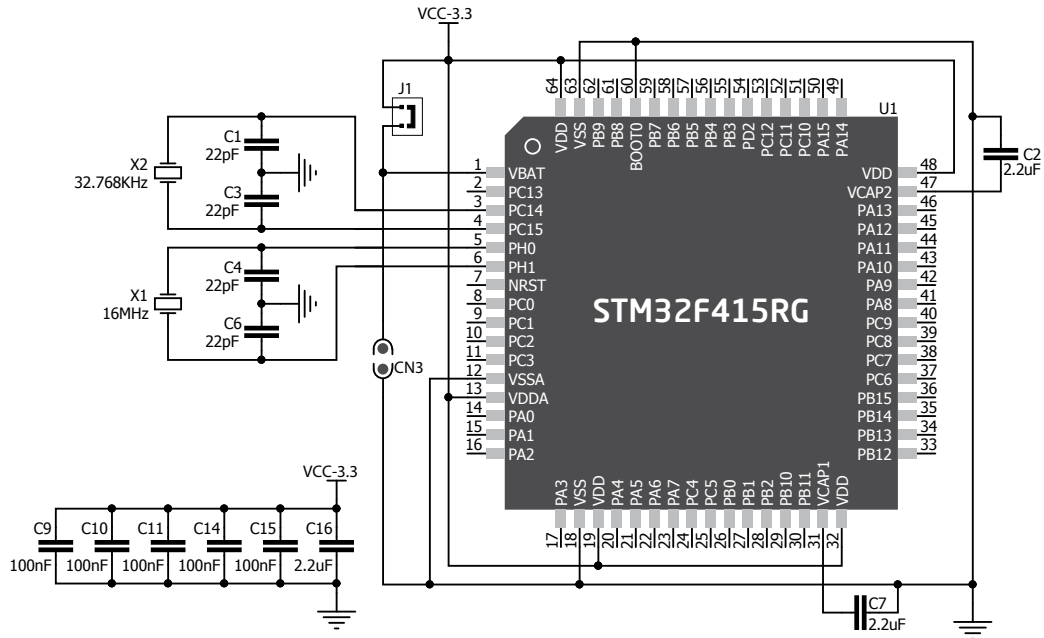


Figure 6-2: RTC battery schematic

7. click boards are plug and play!

Up to now, MikroElektronika has released more than 90 mikroBUS™ compatible **click™ Boards**. On the average, one click board is released per week. It is our intention to provide you with as many add-on boards as possible, so you will be able to expand your development board with additional functionality. Each board comes with a set of working example code. Please visit the click™ boards webpage for the complete list of currently available boards:



www.mikroe.com/click

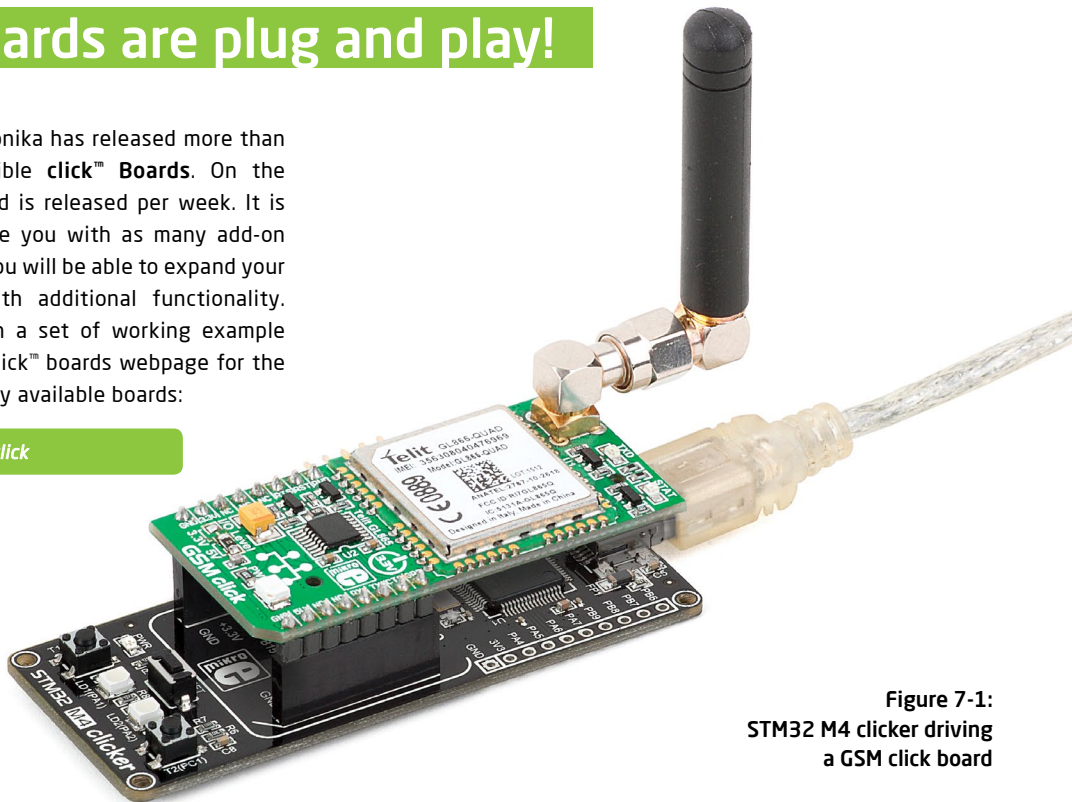
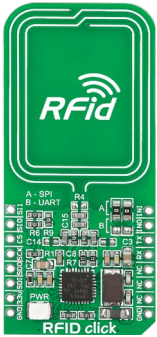
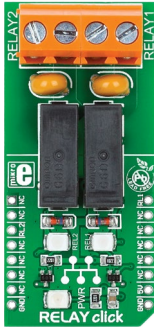


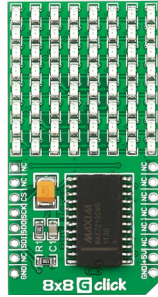
Figure 7-1:
STM32 M4 clicker driving
a GSM click board



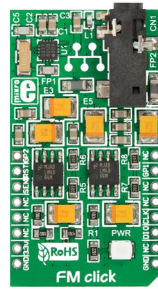
RFid click™



Relay click™



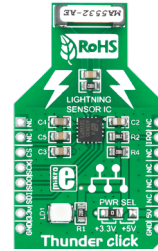
8x8 click™



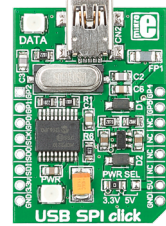
FM click™



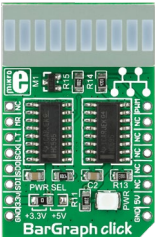
Bluetooth2 click™



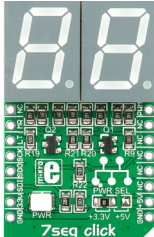
Thunder click™



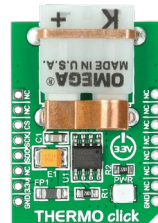
USB SPI click™



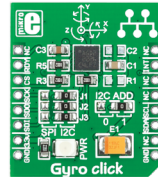
BarGraph click™



7seg click™



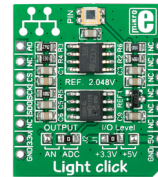
THERMO click™



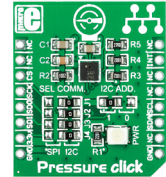
Gyro click™



EEPROM click™



LightHz click™



Pressure click™

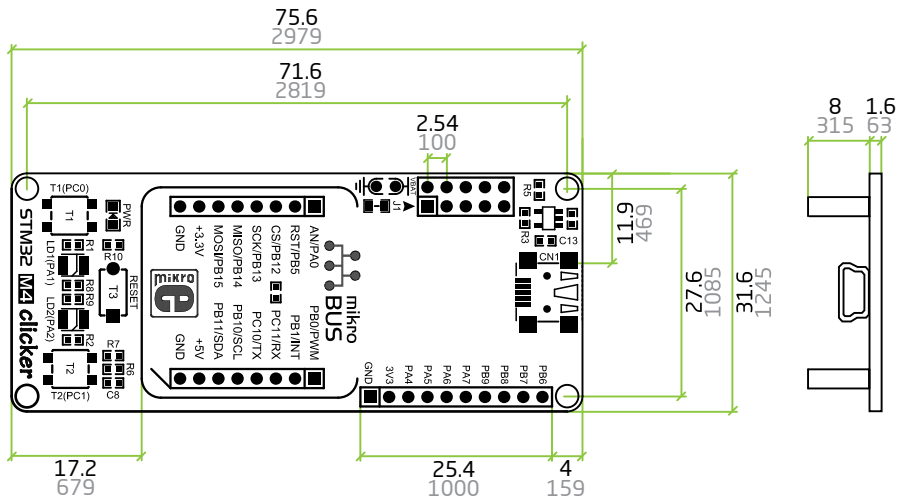
8. Dimensions

Legend

— mm
 — mils

Mounting hole size

∅2 mm
 ∅79 mils



DISCLAIMER

All the products owned by MikroElektronika are protected by copyright law and international copyright treaty. Therefore, this manual is to be treated as any other copyright material. No part of this manual, including product and software described herein, may be reproduced, stored in a retrieval system, translated or transmitted in any form or by any means, without the prior written permission of MikroElektronika. The manual PDF edition can be printed for private or local use, but not for distribution. Any modification of this manual is prohibited.

MikroElektronika provides this manual 'as is' without warranty of any kind, either expressed or implied, including, but not limited to, the implied warranties or conditions of merchantability or fitness for a particular purpose.

MikroElektronika shall assume no responsibility or liability for any errors, omissions and inaccuracies that may appear in this manual. In no event shall MikroElektronika, its directors, officers, employees or distributors be liable for any indirect, specific, incidental or consequential damages (including damages for loss of business profits and business information, business interruption or any other pecuniary loss) arising out of the use of this manual or product, even if MikroElektronika has been advised of the possibility of such damages. MikroElektronika reserves the right to change information contained in this manual at any time without prior notice, if necessary.

HIGH RISK ACTIVITIES

The products of MikroElektronika are not fault - tolerant nor designed, manufactured or intended for use or resale as on - line control equipment in hazardous environments requiring fail - safe performance, such as in the operation of nuclear facilities, aircraft navigation or communication systems, air traffic control, direct life support machines or weapons systems in which the failure of Software could lead directly to death, personal injury or severe physical or environmental damage ('High Risk Activities'). MikroElektronika and its suppliers specifically disclaim any expressed or implied warranty of fitness for High Risk Activities.

TRADEMARKS

The MikroElektronika name and logo, mikroC™, mikroBasic™, mikroPascal™, Visual TFT™, Visual GLCD™, mikroProg™, Ready™, MINI™, mikroBUS™, EasyPIC™, EasyAVR™, Easy8051™, click™ boards and mikromedia™ are trademarks of MikroElektronika. All other trademarks mentioned herein are property of their respective companies. All other product and corporate names appearing in this manual may or may not be registered trademarks or copyrights of their respective companies, and are only used for identification or explanation and to the owners' benefit, with no intent to infringe.

Copyright © 2014 MikroElektronika. All Rights Reserved.



If you want to learn more about our products, please visit our web site at www.mikroe.com

If you are experiencing some problems with any of our products or just need additional information, please place your ticket at www.mikroe.com/support

If you have any questions, comments or business proposals,
do not hesitate to contact us at office@mikroe.com

STM32 M4 clicker manual
ver. 1.00

