

DESCRIPTION: POWER / SIGNAL - VERTICAL - FEMALE - MACHINED

SPECIFICATIONS:

ELECTRICAL:

INSULATION RESISTANCE:	5 Gohms MIN.
DIELECTRIC WITHSTANDING VOLTAGE:	1000 VAC FOR 1 MIN
WORKING VOLTAGE:	250V
OPERATING TEMPERATURE:	-55°C TO +125°C
POWER CONTACT RESISTANCE:	2.0 mOhms MAX.
SIGNAL CONTACT RESISTANCE:	10 mOhms MAX.
POWER CONTACT AMPERAGE:	SEE P/N KEY
SIGNAL CONTACT AMPERAGE:	5 AMPS

MECHANICAL:

CONTACT INSERTION FORCE:	4.5 Kg MAX.
CONTACT SEPARATION FORCE:	0.3 Kg MIN.

MATERIALS:

CONTACTS:	COPPER ALLOY, GOLD FLASH
INSULATOR:	PBT UL94V-0 RATED 230°C PROCESS TEMP.
SHELL:	NICKEL PLATED STEEL
HARDWARE:	NICKEL PLATED BRASS

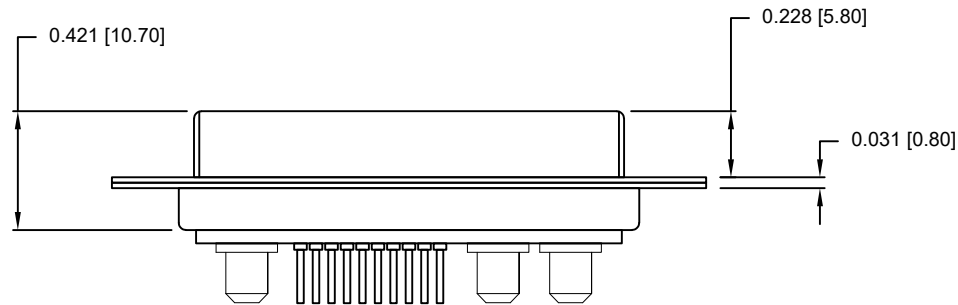
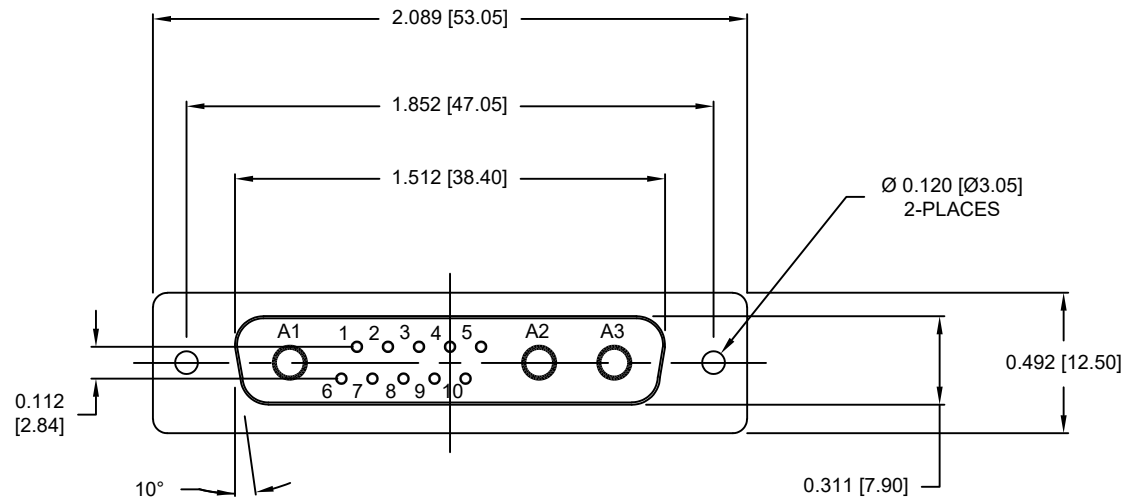

SEE SHEET 2
FOR CONTACT DIMENSION DETAILS

681M13W3203LYYY

0 = 40 AMP POWER // STANDARD PCB TAILS
 1 = 40 AMP POWER // 2.22mm PCB TAILS
 2 = 20 AMP POWER // STANDARD PCB TAILS
 (91 OPTION BELOW SUPERCEDES ABOVE OPTIONS)

0 = NO HARDWARE
 1 = 0.098" CN PCB SIDE
 2 = 0.236" CN PCB SIDE
 3 = 0.236" CN MATING SIDE
 4 = 0.237" BOARDLOCK PCB SIDE
 5 = 0.224" BOARDLOCK PCB SIDE
 91 = 0.237" BOARDLOCK PCB SIDE WITH SCREW LOCK &
 40 AMP POWER // STANDARD PCB TAILS

1 = GOLD FLASH

RoHS COMPLIANT

UNITS = inches [mm]

DO NOT SCALE FROM DRAWING



THESE DRAWINGS AND SPECIFICATIONS ARE THE PROPERTY OF NorComp AND SHALL NOT BE REPRODUCED, COPIED OR USED AS THE BASIS FOR THE MANUFACTURE OR SALE OF APPARATUS WITHOUT WRITTEN PERMISSION.

DRAWN:
M. SIGMON

DATE:
05/02/2013

NorComp

SCALE:
NTS

SHEET 1 OF 3

REV 5

DWG NO.

681M13W3203LYYY

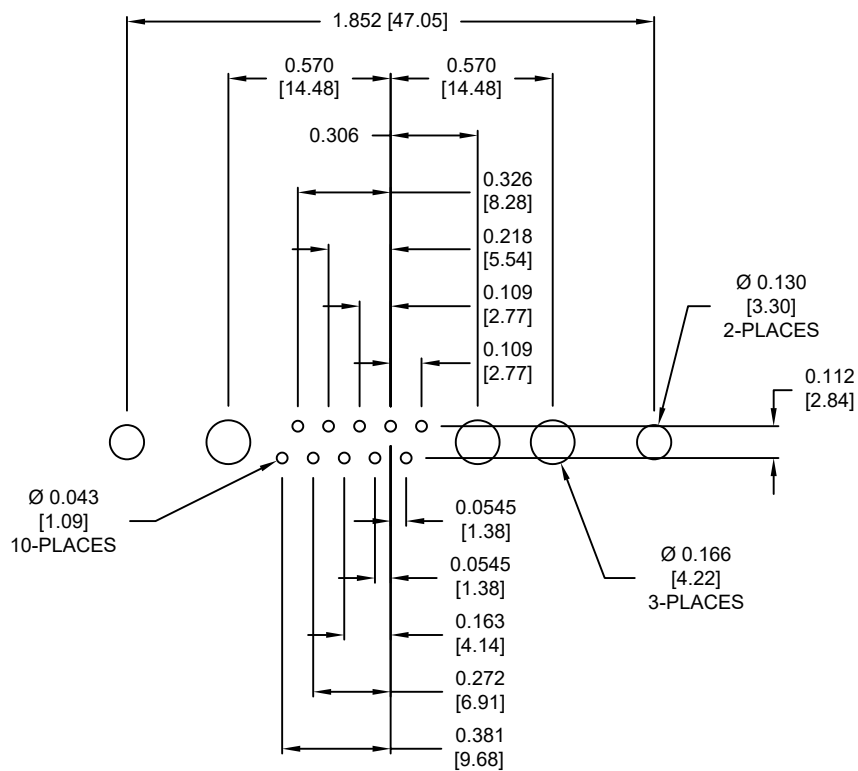

RECOMMENDED PCB LAYOUT

NOTE:
SIGNAL AND POWER CONTACTS
COME PRE-LOADED INTO INSULATORS

DIMENSIONS(in/mm)		
OPTION	S	P
0 & 2	0.218	0.177
	5.55	4.50
1	0.118	0.087
	3.02	2.22

SIGNAL CONTACTS

POWER CONTACTS

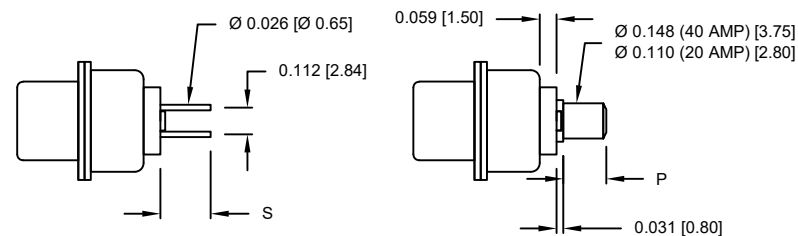

RoHS COMPLIANT

UNITS = inches [mm]

DO NOT SCALE FROM DRAWING



THESE DRAWINGS AND SPECIFICATIONS ARE THE PROPERTY OF NorComp AND SHALL NOT BE REPRODUCED, COPIED OR USED AS THE BASIS FOR THE MANUFACTURE OR SALE OF APPARATUS WITHOUT WRITTEN PERMISSION.

DRAWN:
M. SIGMON

DATE:
05/02/2013

NorComp

SCALE:
NTS

SHEET 2 OF 3

REV 5

DWG NO.

681M13W3203LYYY

ALL CLINCH-NUTS ARE 4-40 INTERNAL THREADS

TOLERANCE:
ALL DIMENSIONS ARE ±0.010

0 NO HARDWARE

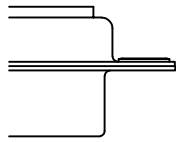

2 0.236" PCB SIDE

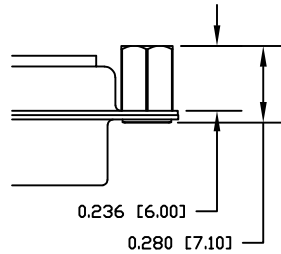

4 0.237" PCB SIDE

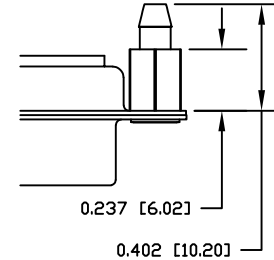

1 0.098" PCB SIDE

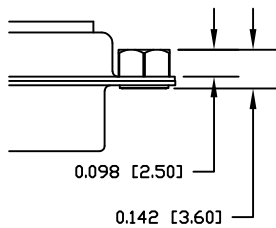

3 0.236" MATING SIDE

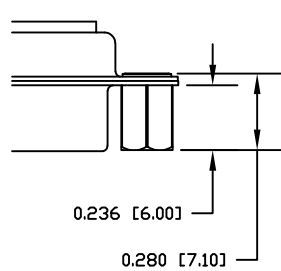

5 0.224" PCB SIDE

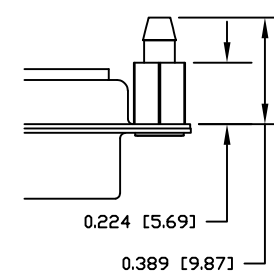

91 0.237" PCB SIDE & SCREW LOCK

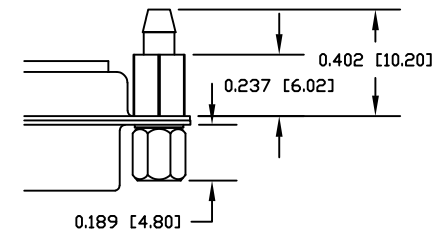

RoHS COMPLIANT

UNITS = inches [mm] DO NOT SCALE FROM DRAWING



THESE DRAWINGS AND SPECIFICATIONS ARE THE PROPERTY OF NorComp AND SHALL NOT BE REPRODUCED, COPIED OR USED AS THE BASIS FOR THE MANUFACTURE OR SALE OF APPARATUS WITHOUT WRITTEN PERMISSION.

DRAWN:
M. SIGMON

DATE:
05/02/2013

NorComp

SCALE:
NTS

SHEET 3 OF 3

REV 5

DWG NO.

681M13W3203LYYY