

Part No. 1001013

## Wi-Fi / BT SMD On Ground / Off Ground Antenna

2400 - 2485 MHz

Supports: Wi-Fi applications, Agriculture, Automotive, Bluetooth, Zigbee, WLAN, Smart Home, Healthcare, Digital Signage



### FR4 Wi-Fi / Bluetooth Antenna

2400 – 2485 MHz

#### KEY BENEFITS

##### Stay-in-Tune

IMD antenna technology provides superior RF field containment, resulting in less interaction with surrounding components.

##### Quicker Time-to-Market

By optimizing antenna size, performance and emissions, customer and regulatory specifications are more easily met.

##### Reliability

Products are the latest RoHS version compliant.

#### APPLICATIONS

- Embedded design
- Cellular, Headsets, Tablets
- Gateway, Access Point
- Handheld
- Telematics
- Tracking
- Healthcare
- M2M, Industrial devices
- Smart Grid
- OBD-II

Ethertronics' antennas deliver on the key needs of device designers for higher functionality and performance in smaller/thinner designs. These innovative antennas provide compelling advantages for a 2.4 GHz enabled handheld devices, media players and other mobile devices.

#### Real-World Performance and Implementation

Antennas may look alike on the outside, but the important difference is inside. Other antennas may contain simple PIFA or monopole designs that interact with their surroundings, complicating layout or changing performance with use position. Ethertronics' antennas utilize patented IMD technology to deliver a unique size and performance combination.

#### Greater Flexibility

Ethertronics' IMD technology enables the advance antenna design that delivers superior performance in reception critical applications. 1001013 is capable of being used in off-ground and on-ground (over metal) environments.

#### Electrical Specifications

Typical Characteristics, on 50 x 70 mm PCB

Frequency	2400 – 2485 MHz	
Mounting	Off Ground	On Ground (Over Metal)
VSWR Match	1.5:1 max	1.8:1 max
Average Efficiency	76%	48%
Peak Gain	2.6 dBi	0.7 dBi
Feed Point Impedance	50 ohms unbalanced	
Polarization	Linear	
Power Handling	0.5 Watt CW	

#### Mechanical Specifications & Ordering Part Number

Ordering Part Number	1001013
Size (mm)	15.0 x 3.2 x 3.3
Mounting	Surface mounted to the PCB
Weight (grams)	0.2
Packaging	Tape & Reel
Demo Board	1001013-02



2.4 GHz Ethertronics' Embedded Antenna Specifications.  
Ethertronics produces a wide variety of standard and custom antennas to meet user needs.

### Antenna Dimensions

Typical antenna dimensions (mm)

Part Number	A (mm)	B (mm)	C (mm)
1001013	15.0 ± 0.2	3.2 ± 0.2	3.3 ± 0.3

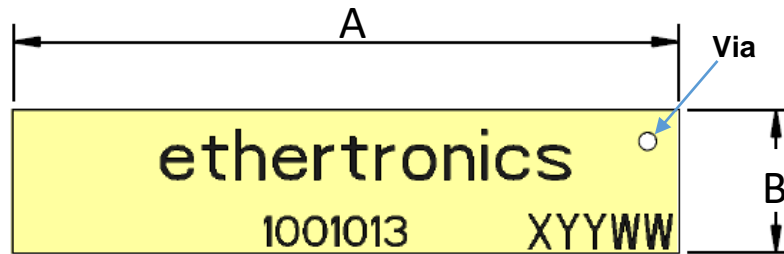
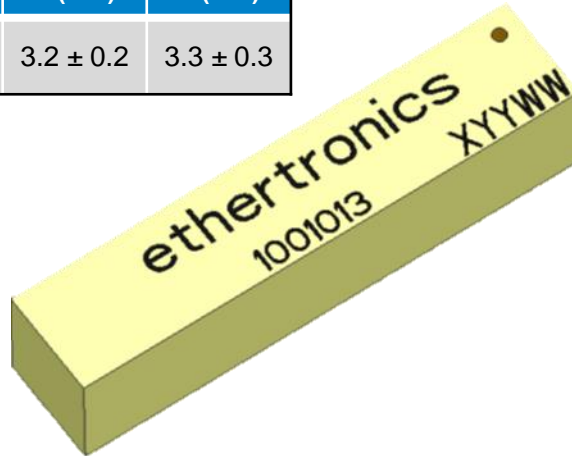

**Top View**

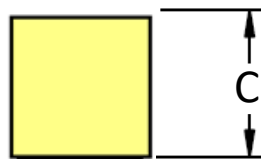

**Height**

Pin	Description
1	Feed
2	Dummy Pad
3	Dummy Pad

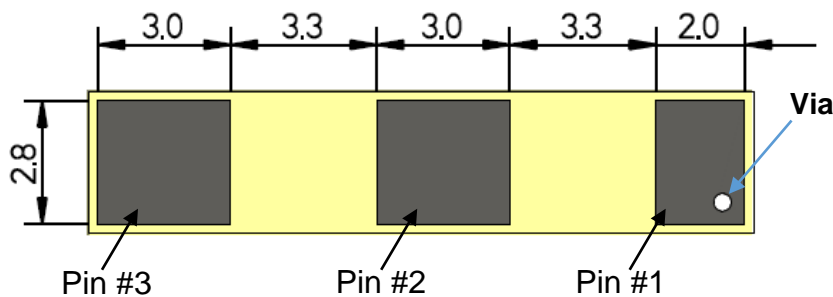

**Bottom View**



2.4 GHz Ethertronics' Embedded Antenna Specifications.  
Ethertronics produces a wide variety of standard and custom antennas to meet user needs.

**VSWR and Efficiency Plots (Off-Ground)**

Typical performance on 50 x 70 mm PCB

**VSWR**

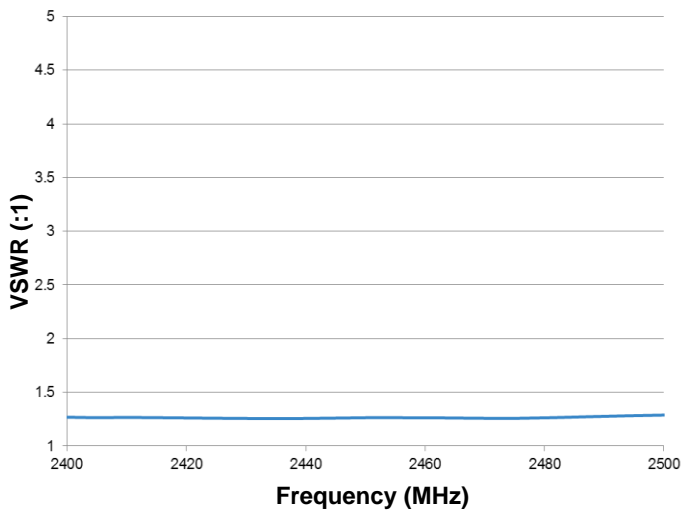

**Efficiency**

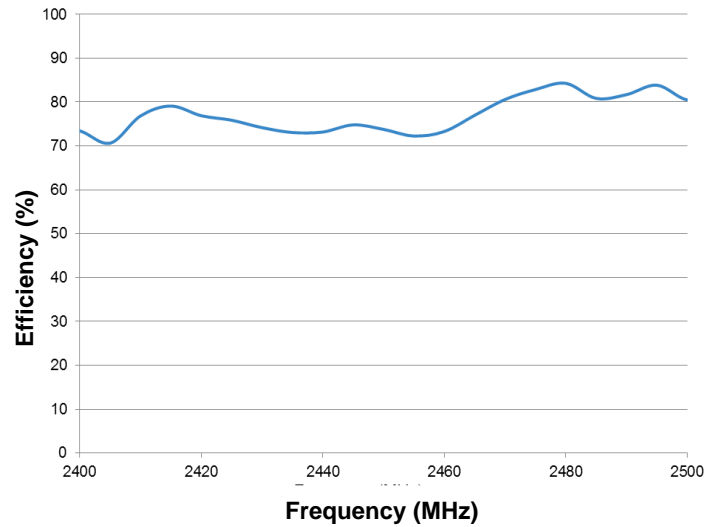

**Antenna Radiation Patterns (Off-Ground)**

Typical performance on 50 x 70 mm PCB

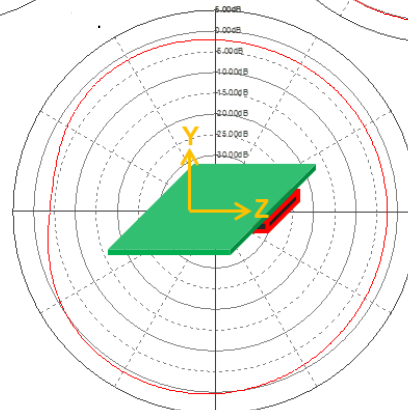
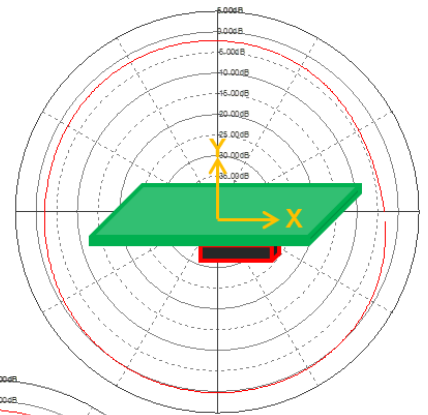
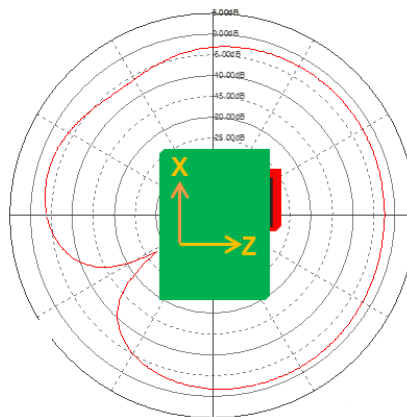
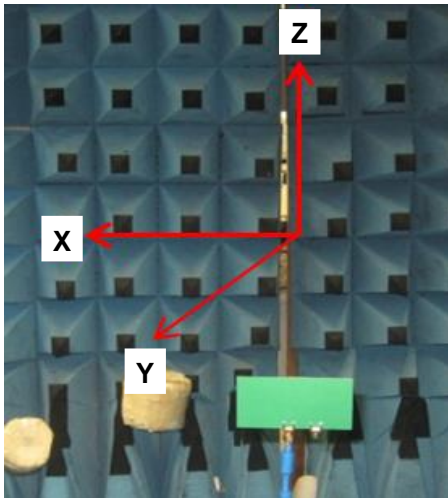



2.4 GHz Ethertronics' Embedded Antenna Specifications.  
Ethertronics produces a wide variety of standard and custom antennas to meet user needs.

Antenna Layout (Off-Ground)

Typical layout dimensions (mm)

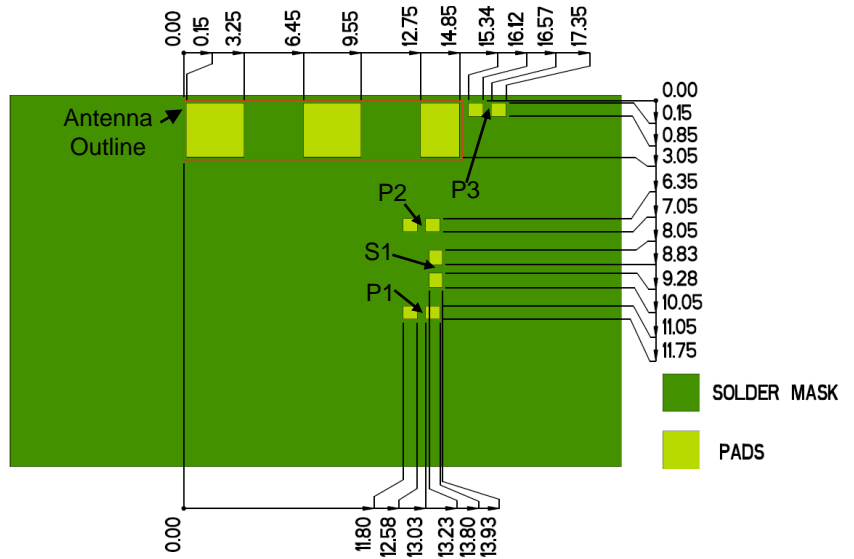
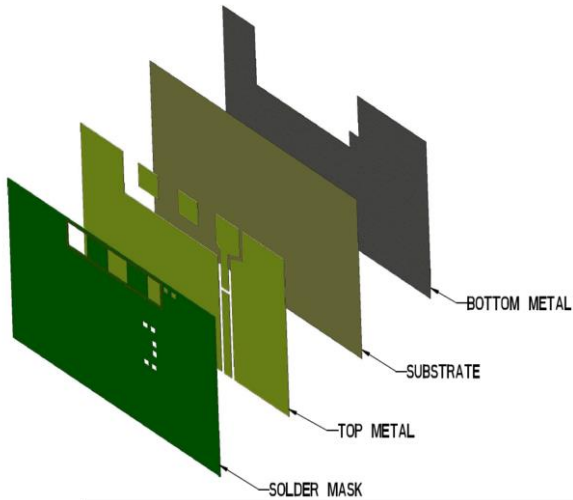

\* VIAS: Diam. 0.2mm, (no vias on transmission lines).  
Via holes must be covered by solder mask

Pin Descriptions

Pin#	Description
1	Feed
2	Dummy Pad
3	Dummy Pad

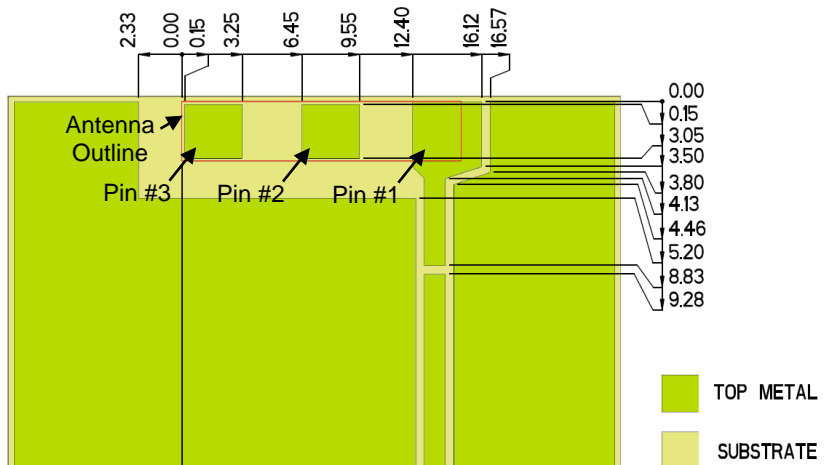

Matching Pi Network (Demo Board)

Component	Value	Tolerance
P1	DNI	N/A
S1	0Ω	N/A
P2	0.4pF	±0.25pF
P3	0Ω	N/A

\*Actual matching values depend on customer design

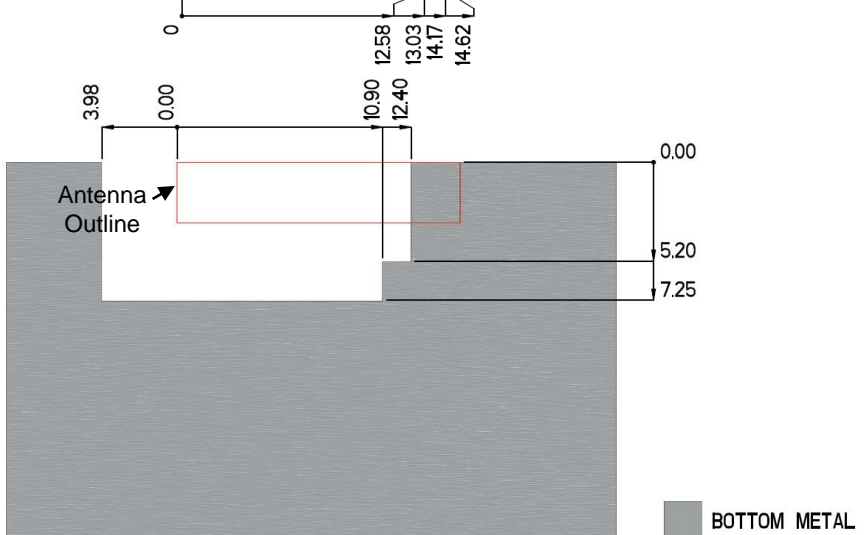
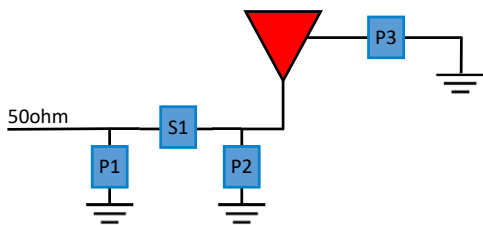



2.4 GHz Ethertronics' Embedded Antenna Specifications.  
Ethertronics produces a wide variety of standard and custom antennas to meet user needs.

**VSWR and Efficiency Plots (On-Ground)**

Typical performance on 50 x 70 mm PCB

**VSWR**

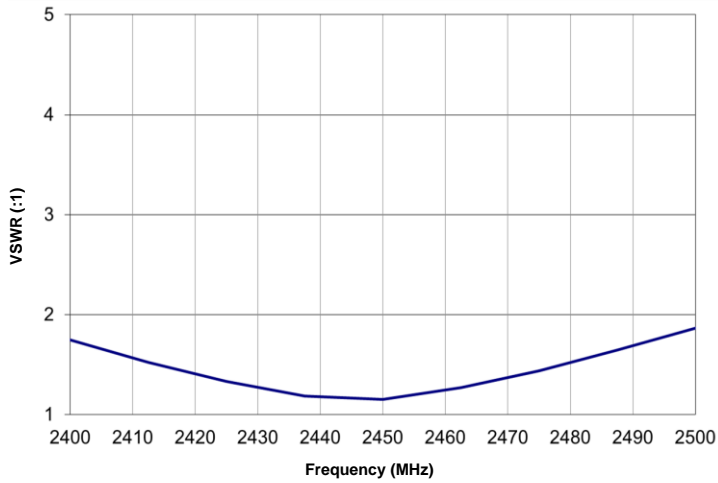

**Efficiency**

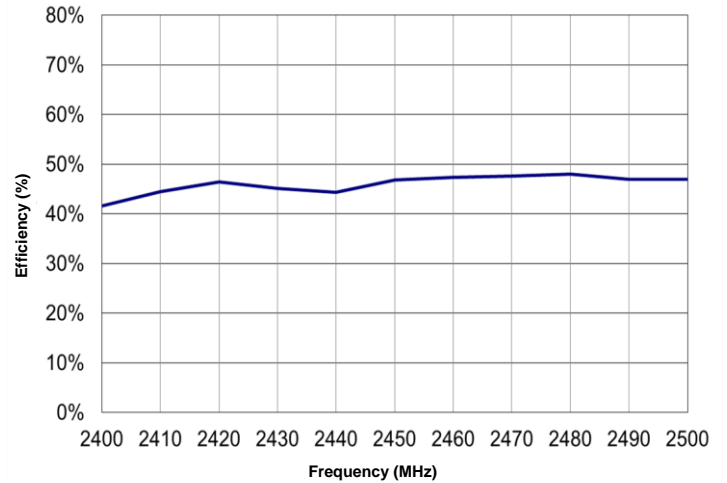

**Antenna Radiation Patterns (On-Ground)**

Typical performance on 50 x 70 mm PCB

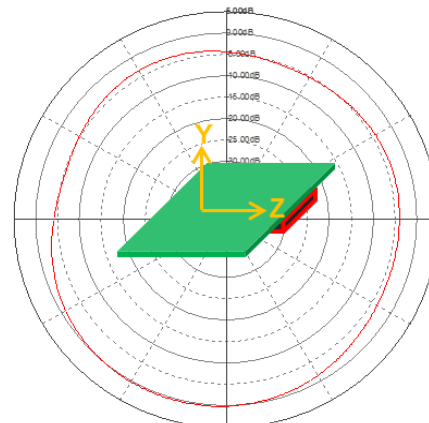
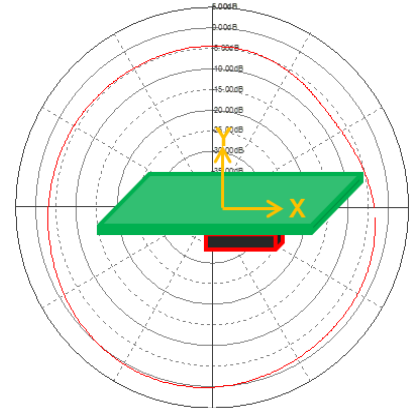
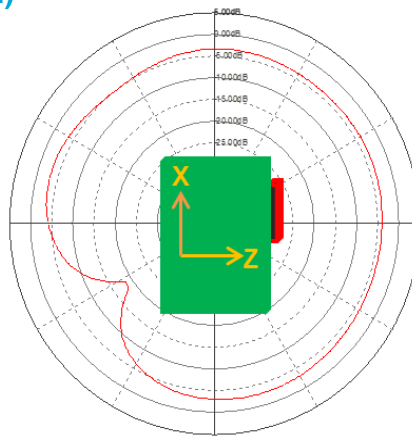
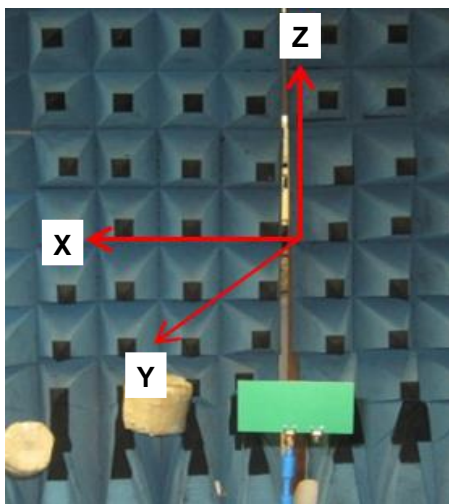



2.4 GHz Ethertronics' Embedded Antenna Specifications.  
Ethertronics produces a wide variety of standard and custom antennas to meet user needs.

Antenna Layout (On-Ground)

Typical layout dimensions (mm)

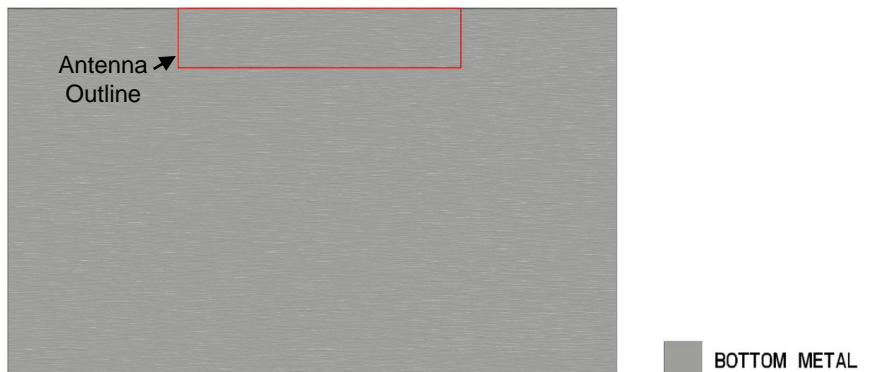
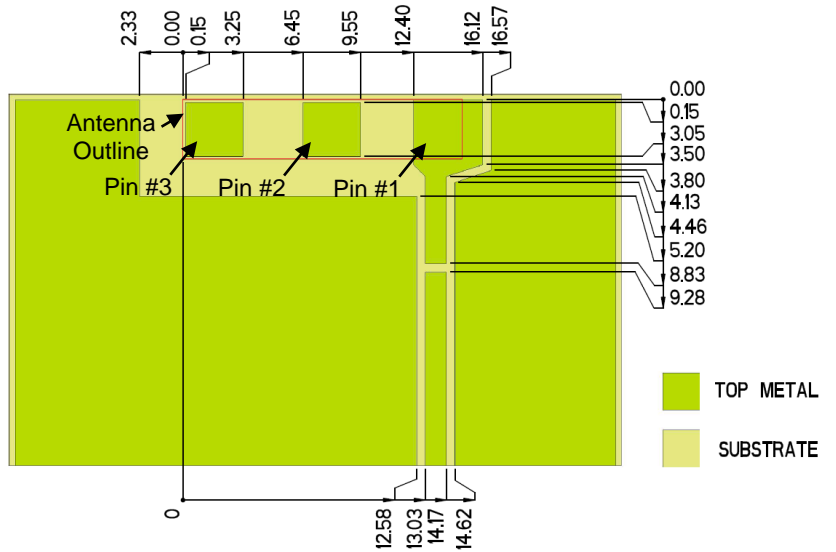
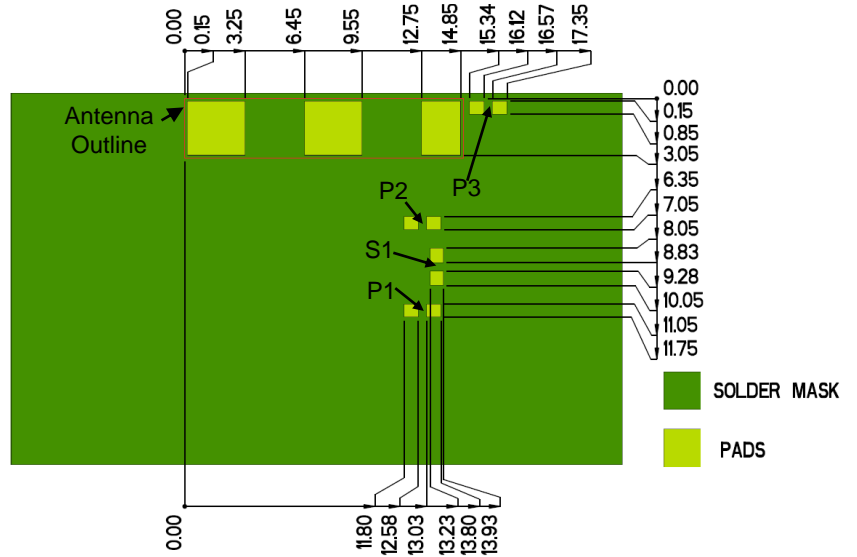
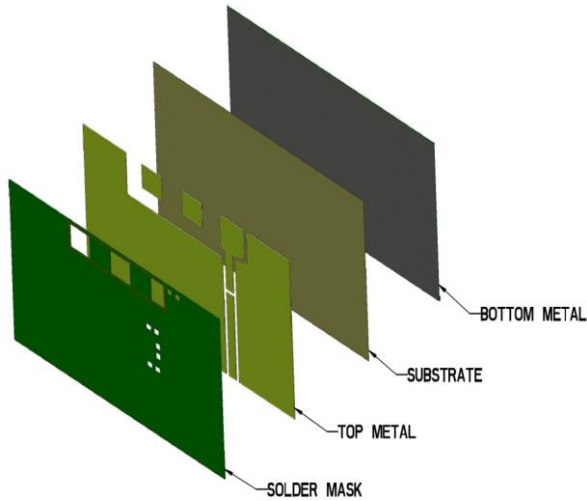

\* VIAS: Diam. 0.2mm, (no vias on transmission lines).  
Via holes must be covered by solder mask

Pin Descriptions

Pin#	Description
1	Feed
2	Dummy Pad
3	Dummy Pad

Matching Pi Network (Demo Board)

Component	Value	Tolerance
P1	DNI	N/A
S1	0Ω	N/A
P2	DNI	N/A
P3	0Ω	N/A

\*Actual matching values depend on customer design

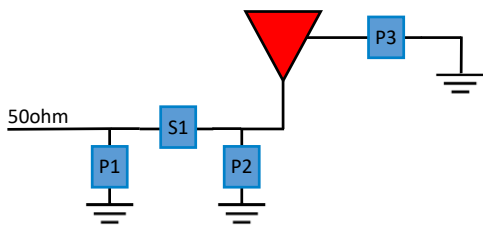



2.4 GHz Ethertronics' Embedded Antenna Specifications.  
Ethertronics produces a wide variety of standard and custom antennas to meet user needs.

**Antenna Demo Board**  
1001013-02 Off-Ground

Part Number	A (mm)	B (mm)	C (mm)
1001013-02	70.0	50.0	15.0

