

Data sheet | Item number: 788-307

Relay module; Nominal input voltage: 110 VDC; 1 changeover contact;
Limiting continuous current: 16 A; Red status indicator; Module width: 15 mm; 2,50 mm²; gray

www.wago.com/788-307

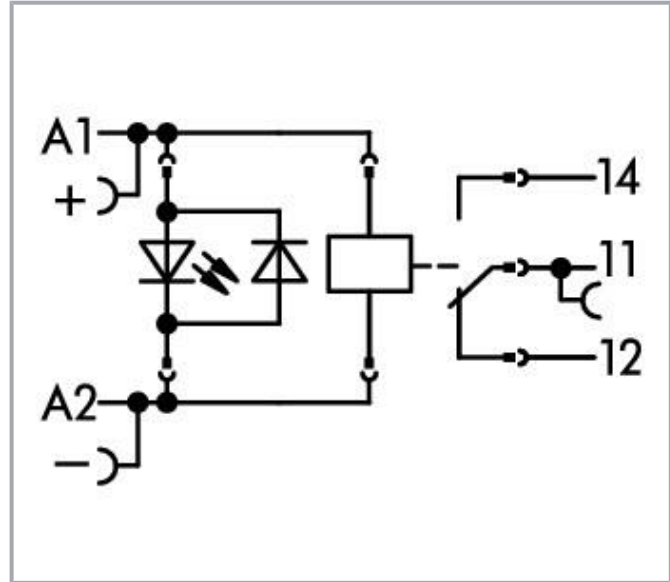
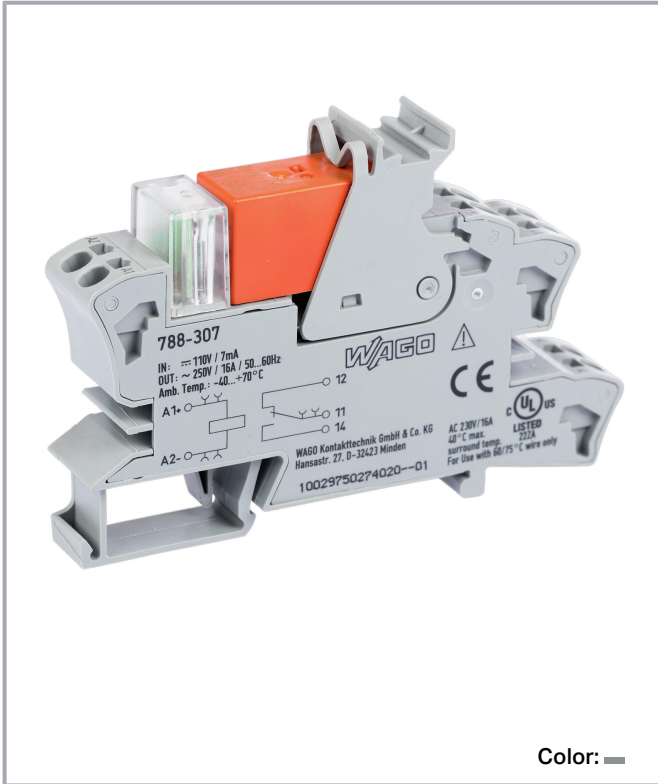

Color: —

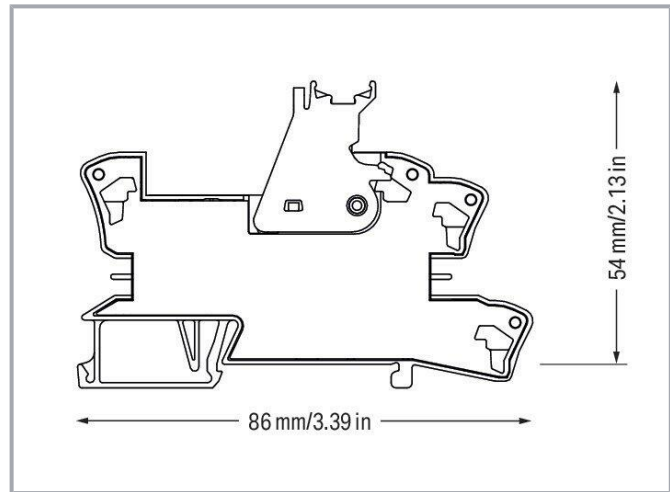
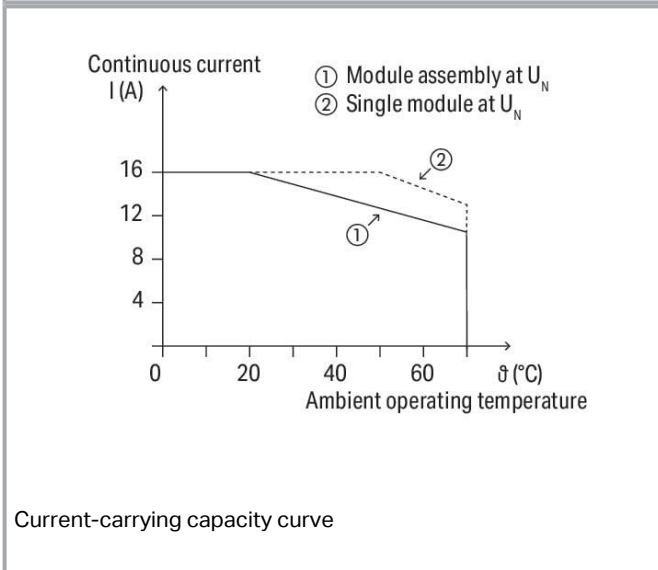

Subject to changes. Please also observe the further product documentation!

WAGO GmbH & Co. KG
Hansastr. 27
32423 Minden
Phone: +49571 887-0 | Fax: +49571 887-169
Email: info.de@wago.com | Web: www.wago.com

Do you have any questions about our products?
We are always happy to take your call at +49 (571) 887-44222.

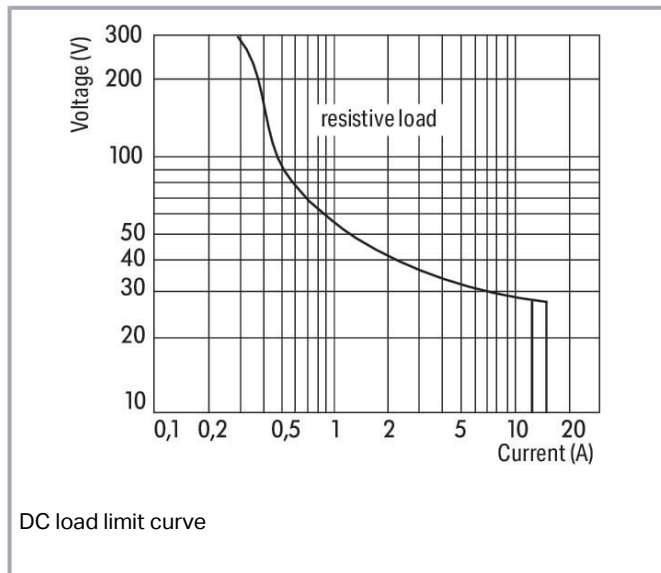

Data

Notes

Safety information

A separator plate (e.g., 209-191) must be used for voltages greater than 250 V between adjacent relay modules and for compliance with the reinforced insulation requirements.

Note

- Reinforced insulation between coil and contacts
- To protect the relay coils and contacts, inductive loads must be dampened with an effective protection circuit.

Technical data

Control Circuit

Nominal input voltage U_N	DC 110 V
Input voltage range	$\pm 10\%$
Nominal input current at U_N	6 mA

Load circuit

Number of changeover/switchover contacts	1
Contact material (relay)	AgNi 90/10
Limiting continuous current	16 A

Subject to changes. Please also observe the further product documentation!

WAGO GmbH & Co. KG

Hansastr. 27

32423 Minden

Phone: +49571 887-0 | Fax: +49571 887-169

Email: info.de@wago.com | Web: www.wago.com

Do you have any questions about our products?

We are always happy to take your call at +49 (571) 887-44222.



Inrush current (resistive) max.	(AC) 30 A / 4 s
Switching voltage (max.)	AC 250 V
Switching power (resistive) max.	AC 4000 VA; DC (see load limit curve)
Switching capacity	AC-15: 6 A / AC 250 V; DC-13: 2 A / DC 24 V
Recommended minimum load	12 V / 10 mA
Pull-in time (typ.)	8 ms
Drop-out time (typ.)	6 ms
Bounce time (typ.)	6 ms
Electrical life (NO; resistive load; 23 °C)	30 x 10 ³ switching operations
Mechanical life	30 x 10 ⁶ switching operations
Switching frequency with/without load (max.)	6 min ⁻¹ / 1200 min ⁻¹

Signaling

Status indicator	Red LED
------------------	---------

Safety and protection

Rated voltage	250 V
Rated surge voltage	4 kV
Pollution degree	3
Dielectric strength (control/load circuit) (AC, 1 min)	5 kVrms
Dielectric strength (open contact) (AC, 1 min)	1 kVrms
Safety information	A separator plate (e.g., 209-191) must be used for voltages greater than 250 V between adjacent relay modules and for compliance with the reinforced insulation requirements.
Protection type	IP20

Connection data

Connection technology	Push-in CAGE CLAMP®
Solid conductor	0.34 ... 2.5 mm ² / 22 ... 14 AWG
Fine-stranded conductor	0.34 ... 2.5 mm ² / 22 ... 14 AWG
Strip length	9 ... 10 mm / 0.35 ... 0.39 inches

Physical data

Width	15 mm / 0.591 inches
Height	86 mm / 3.386 inches
Depth from upper-edge of DIN-rail	54 mm / 2.126 inches

Subject to changes. Please also observe the further product documentation!

WAGO GmbH & Co. KG
 Hansastr. 27
 32423 Minden
 Phone: +49571 887-0 | Fax: +49571 887-169
 Email: info.de@wago.com | Web: www.wago.com

Do you have any questions about our products?
 We are always happy to take your call at +49 (571) 887-44222.



Mechanical data

Mounting type	DIN-35 rail
---------------	-------------

Material Data

Color	gray
Fire load	0.673 MJ
Weight	46.5 g

Environmental requirements

Ambient temperature (operation at U_N)	-40 ... +70 °C
Ambient temperature UL (operation at U_N)	-40 ... +40 °C
Ambient temperature (storage)	-40 ... +70 °C
Processing temperature	-25 ... +50 °C
Temperature range of connection cable	$\geq (T_{\text{ambient}} + 20 \text{ K})$

Standards and specifications

Standards/specifications	EN 61010-2-201 EN 61810-1 EN 61373 UL 508 (max. 40 °C/10 A)
--------------------------	--

Basic relay

WAGO Basic Relay	788-166
------------------	---------

Commercial data

Product Group	6 (INTERFACE ELECTRONIC)
eCl@ss 10.0	27-37-16-01
eCl@ss 9.0	27-37-16-01
ETIM 8.0	EC001437
ETIM 7.0	EC001437
PU (SPU)	20 (1) pcs
Packaging type	box
Country of origin	DE
GTIN	4045454520663
Customs tariff number	85364900990

Subject to changes. Please also observe the further product documentation!



Environmental Product Compliance

RoHS Compliance Status

Compliant, No Exemption

Approvals / Certificates

General approvals

Logo	Approval	Additional Approval Text	Certificate name
	EAC Brjansker Zertifizierungsstelle	TP TC 004/2011	EAC RU C-DE.AM02.B.00122/19
	UL Underwriters Laboratories Inc. (ORDINARY LOCATIONS)	UL 508	E175199 Vol.1 Sec. 6

Declarations of conformity and manufacturer's declarations

Logo	Approval	Additional Approval Text	Certificate name
	EU-Declaration of Conformity WAGO GmbH & Co. KG	-	-

Optional accessories

Basic Relay

Basic relay

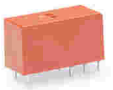
**Item no.: 788-166**Basic relay; Nominal input voltage: 110 VDC; 1 changeover contact; Limiting continuous current: 16 A; www.wago.com/788-166
Module width: 13 mm; Module height: 15 mm

Marking accessories

Marking strip

**Item no.: 2009-110**

Marking strips; for Smart Printer; on reel; not stretchable; plain; snap-on type; white

www.wago.com/2009-110

Double marker carrier

**Item no.: 209-128**

Adaptor; gray

www.wago.com/209-128

Marking devices

Subject to changes. Please also observe the further product documentation!

WAGO GmbH & Co. KG

Hansastr. 27













32423 Minden

Phone: +49571 887-0 | Fax: +49571 887-169

Email: info.de@wago.com | Web: www.wago.com

Do you have any questions about our products?

We are always happy to take your call at +49 (571) 887-44222.

	Item no.: 210-110 Fiber-tip pen	www.wago.com/210-110
Protective marker cover		
	Item no.: 209-184 Protection cover; transparent	www.wago.com/209-184
Marker		
	Item no.: 2009-115 WMB-Inline; for Smart Printer; 1500 pieces on roll; stretchable 5 - 5.2 mm; plain; snap-on type; white	www.wago.com/2009-115
	Item no.: 209-183 Marker; white	www.wago.com/209-183
	Item no.: 793-501 WMB marking card; as card; not stretchable; plain; snap-on type; white	www.wago.com/793-501
	Item no.: 793-502 WMB marking card; as card; MARKED; 1 ... 10 (10x); not stretchable; Horizontal marking; snap-on type; white	www.wago.com/793-502
	Item no.: 793-503 WMB marking card; as card; MARKED; 11 ... 20 (10x); not stretchable; Horizontal marking; snap-on type; white	www.wago.com/793-503
	Item no.: 793-504 WMB marking card; as card; MARKED; 21 ... 30 (10x); not stretchable; Horizontal marking; snap-on type; white	www.wago.com/793-504
	Item no.: 793-505 WMB marking card; as card; MARKED; 31 ... 40 (10x); not stretchable; Horizontal marking; snap-on type; white	www.wago.com/793-505
Group marker carrier		
	Item no.: 209-145 Group marker carrier; white	www.wago.com/209-145
	Item no.: 249-105 Group marker carrier; gray	www.wago.com/249-105
Tool		
Operating tool		
	Item no.: 210-720 Operating tool; Blade: 3.5 x 0.5 mm; with a partially insulated shaft; multicoloured	www.wago.com/210-720
Indicators		
Status indication		





Subject to changes. Please also observe the further product documentation!

**Item no.: 788-122**

Accessories for relay modules; Operation status indicator: red; Nominal operating voltage: 110 VDC



www.wago.com/788-122**Ferrule**

Ferrule

	Item no.: 216-241 Ferrule; Sleeve for 0.5 mm ² / 20 AWG; insulated; electro-tin plated; electrolytic copper; gastight crimped; acc. to DIN 46228, Part 4/09.90; white	www.wago.com/216-241
	Item no.: 216-242 Ferrule; Sleeve for 0.75 mm ² / 18 AWG; insulated; electro-tin plated; electrolytic copper; gastight crimped; acc. to DIN 46228, Part 4/09.90; gray	www.wago.com/216-242
	Item no.: 216-243 Ferrule; Sleeve for 1 mm ² / AWG 18; insulated; electro-tin plated; electrolytic copper; gastight crimped; acc. to DIN 46228, Part 4/09.90; red	www.wago.com/216-243
	Item no.: 216-244 Ferrule; Sleeve for 1.5 mm ² / AWG 16; insulated; electro-tin plated; electrolytic copper; gastight crimped; acc. to DIN 46228, Part 4/09.90; black	www.wago.com/216-244
	Item no.: 216-542 Twin ferrule; Sleeve for 2 x 1 mm ² / AWG 2 x 18; red, insulated; 12 mm long; red	www.wago.com/216-542

Jumpers

Jumper

	Item no.: 788-116 Jumper; for jumper slot; 6-way; insulated; light gray	www.wago.com/788-116
	Item no.: 788-117 Jumper; for jumper slot; 8-way; insulated; light gray	www.wago.com/788-117
	Item no.: 788-114 Jumper; for jumper slot; 3-way; insulated; light gray	www.wago.com/788-114
	Item no.: 788-113 Jumper; for jumper slot; 2-way; insulated; light gray	www.wago.com/788-113
	Item no.: 788-115 Jumper; for jumper slot; 4-way; insulated; light gray	www.wago.com/788-115
	Item no.: 859-402 Jumper; for jumper slot; 2-way; insulated; light gray	www.wago.com/859-402
	Item no.: 788-118 Jumper; for jumper slot; 2-way; from 1 to 3; insulated; light gray	www.wago.com/788-118

Subject to changes. Please also observe the further product documentation!



Downloads Documentation

Bid Text

788-307 X81 - Datei	2019 Feb 19	xml 4.7 kB	Download
------------------------	-------------	---------------	----------

788-307 docx - Datei	2019 Jan 25	docx 16.7 kB	Download
-------------------------	-------------	-----------------	----------

Instruction Leaflet

Sockets with Elementary Relay/ SSR	V 1.0.1 2020 Oct 9	pdf 2.3 MB	Download
------------------------------------	-----------------------	---------------	----------

Additional Information

Disposal and Recycling Electrical and electronic equipment, Batteries, Packaging	V 1.1.0 2022 Aug 18	pdf 2.2 MB	Download
---	------------------------	---------------	----------

CAD/CAE-Data

CAD data

2D/3D Models 788-307	URL	Download
----------------------	-----	----------

CAE data

EPLAN Data Portal 788-307	URL	Download
---------------------------	-----	----------

ZUKEN Portal 788-307	URL	Download
----------------------	-----	----------

WSCAD Universe 788-307	URL	Download
------------------------	-----	----------

Environmental Product Compliance

Compliance Search

Environmental Product Compliance 788-307 Relay module; Nominal input voltage: 110 VDC; 1 changeover contact; Limiting continuous current: 16 A; Red status indicator; Module width: 15 mm; 2,50 mm ² ; gray	URL	Download
---	-----	----------

Subject to changes. Please also observe the further product documentation!

Installation Notes

Conductor termination

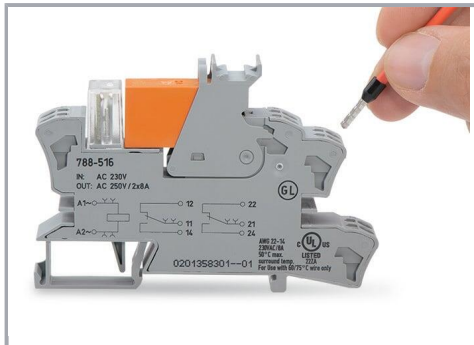

Conductor termination

Commoning

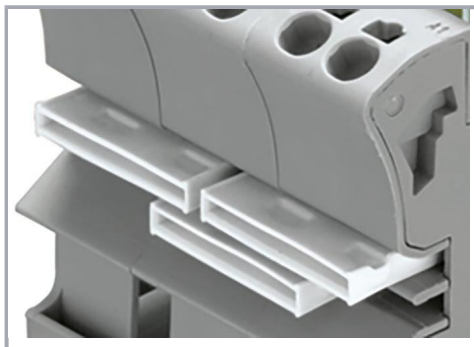

Easy commoning using adjacent jumpers

Marking

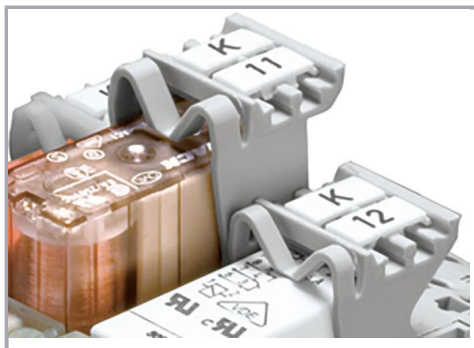

Marking using WMB Multi markers and group marker carriers.

Subject to changes. Please also observe the further product documentation!