

LTM4641

38V, 10A, Step-Down μ Module Regulator with Advanced Input and Load Protection

DESCRIPTION

Demonstration circuit 1543B features the [LTM®4641](#), a high efficiency, high density switch mode step-down power μ Module regulator with superior input and load protection features. The input voltage range is from 4.5V to 38V. The output voltage is jumper programmable from 0.8V to 6V with a rated load current of 10A. Derating is necessary for certain V_{IN} , V_{OUT} , frequency and thermal conditions. DC1543B offers the TRACK/SS pin allowing the user to program output tracking or soft-start period. The DC1543B allows the user to enable/disable input undervoltage

protection; input latching/non-latching overvoltage protection; and latching/non-latching overtemperature protection.

Higher efficiency at low load currents is achieved by setting the MODE pin jumper to DCM. The LTM4641 data sheet must be read in conjunction with this demo manual prior to working on or modifying demo circuit 1543B.

[Design files for this circuit board are available.](#)

All registered trademarks and trademarks are the property of their respective owners.

PERFORMANCE SUMMARY

PARAMETER	CONDITIONS	VALUE
Input Voltage Range		4.5V to 38V
Output Voltage V_{OUT}	Jumper Selectable	0.8V, 1.0V, 1.2V, 1.5V, 1.8V, 3.3V, 5V, 6V; $\pm 1.5\%$
Maximum Continuous Output Current	Derating is Necessary for Certain Operating Conditions. See Data Sheet for Details.	10A _{DC}
Default Operating Frequency	$R_{FSET} = 680k\Omega$ for $V_{OUT} = 0.8V, 1.0V, 1.2V, 1.5V, 1.8V$; $R_{FSET} = \infty$ (Not Stuffed) for $V_{OUT} = 3.3V, 5.0V, 6.0V$	255kHz ($V_{OUT} = 0.8V$); 320kHz ($V_{OUT} = 1.0V$); 385kHz ($V_{OUT} = 1.2V$); 480kHz ($V_{OUT} = 1.5V$); 575kHz ($V_{OUT} = 1.8V$); 360kHz ($V_{OUT} = 3.3V$); 550kHz ($V_{OUT} = 5.0V$); 660kHz ($V_{OUT} = 6.0V$);
Efficiency	$V_{IN} = 12V, V_{OUT} = 6V, I_{OUT} = 10A$	93.0% See Figure 2
Load Transient	$V_{IN} = 12V, V_{OUT} = 3.3V$	See Figure 3

BOARD PHOTO

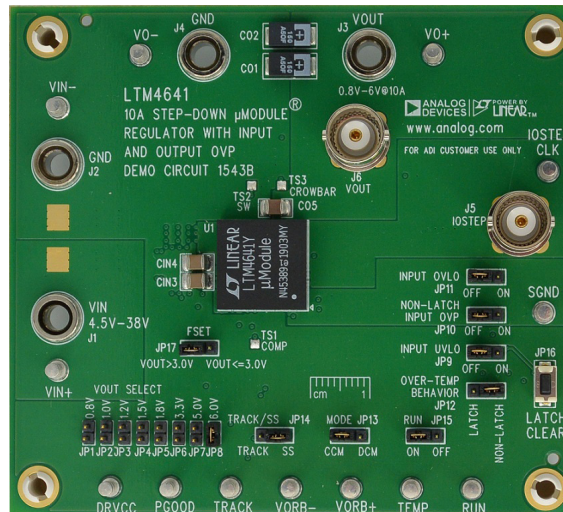

QUICK START PROCEDURE

Demonstration circuit 1543B is an easy way to evaluate the performance of the LTM4641. Please refer to Figure 1 for proper measurement equipment setup and follow the procedure below:

- Place jumpers in the following positions for a typical $3.3V_{OUT}$ application:

INPUT OVLO	NON-LATCH INPUT OVP	INPUT UVLO	OVER-TEMP BEHAVIOR
OFF	OFF	OFF	NON-LATCH

RUN	MODE	TRACK/SS	V_{OUT} Select	F_{SET}
ON	CCM	SS	3.3V	$V_{OUT} > 3.0V$

- With power off, connect the input power supply, load and meters as shown in Figure 1. Preset the load to 0A and V_{IN} supply to be 0V.
- Turn on the power at the input. Increase V_{IN} to 12V (**Do not apply more than the rated maximum voltage of 38V to the board or the part may be damaged**). The output voltage should be regulated and deliver the selected output voltage $\pm 1.5\%$.
- Vary the input voltage from 4.5V to 38V and adjust the load current from 0A to 10A. Observe the output voltage regulation, ripple voltage, efficiency, and other

parameters. Output voltage ripple may be measured at J6 with a BNC cable and oscilloscope. The probe channel for V_{OUT} should be set at 50Ω termination resistance to match the BNC cable.

- (Optional) For optional load transient test, apply an adjustable pulse signal between IOSTEP_CLK and GND test points. The pulse amplitude sets the load step current amplitude. Keep the pulse width short ($< 1ms$) and pulse duty cycle low ($< 5\%$) to limit the thermal stress on the load transient circuit. The load step current can be monitored with a BNC connected to J5 (25mV/A).
- (Optional) To test the advanced input and load protections, put the corresponding jumper in the "ON" position. For DC1543B, the thresholds for different input and output protections are set as shown below:

INPUT OVLO		36V
NON-LATCH INPUT OVP		32V
INPUT UVLO		8V for Rising Edge 7V for Falling Edge
OVER-TEMP BEHAVIOR	LATCH	145°C
	NON-LATCH	145°C: Cease Regulation 135°C: Resume Regulation

QUICK START PROCEDURE

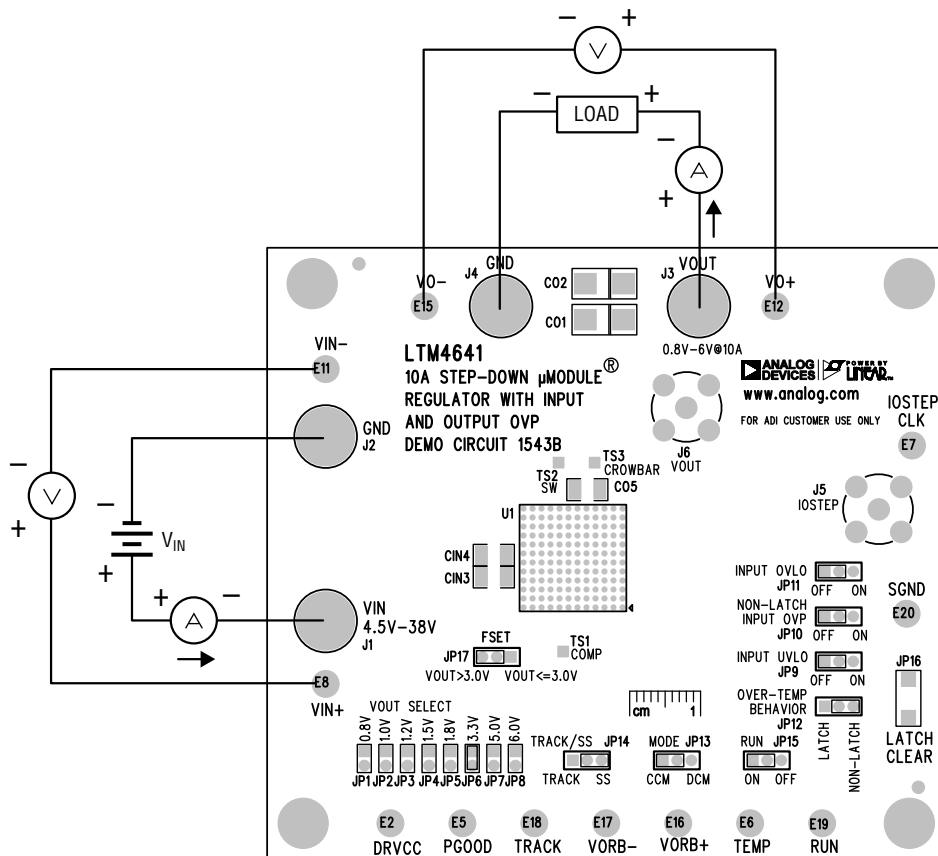
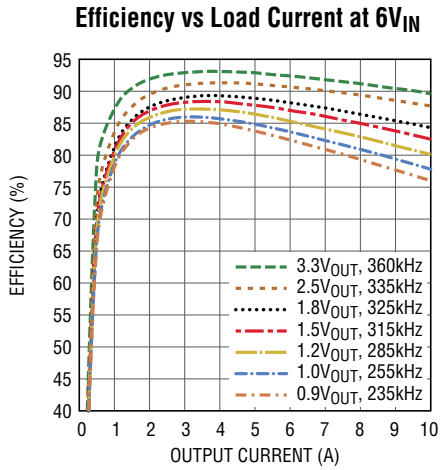
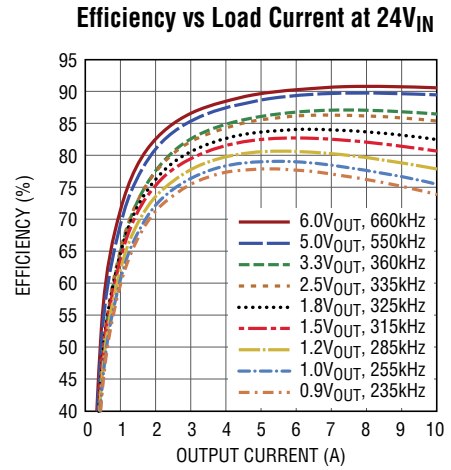

Figure 1. Proper Measurement Equipment Setup

QUICK START PROCEDURE



2a. V_{IN} = 6V



2c. V_{IN} = 24V

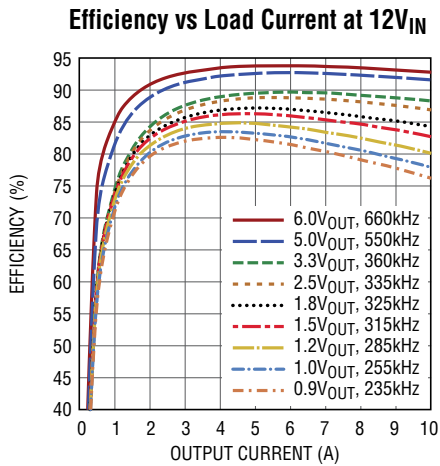

2b. V_{IN} = 12V

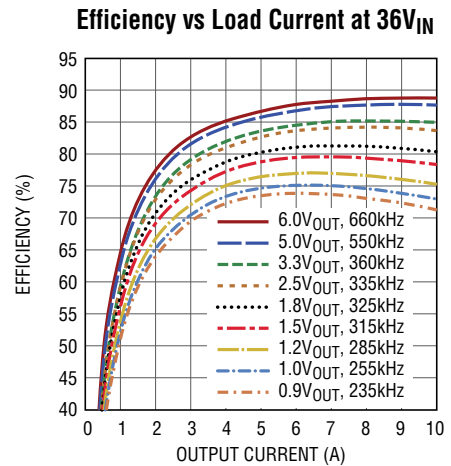

2d. V_{IN} = 36V

Figure 2. Measured DC1543B Efficiency at Different V_{IN}, V_{OUT} and f_{SW} (CCM Mode Enabled)
 Please refer to Table 1 in LTM4641 data sheet for the switching frequency at each output voltage.

QUICK START PROCEDURE

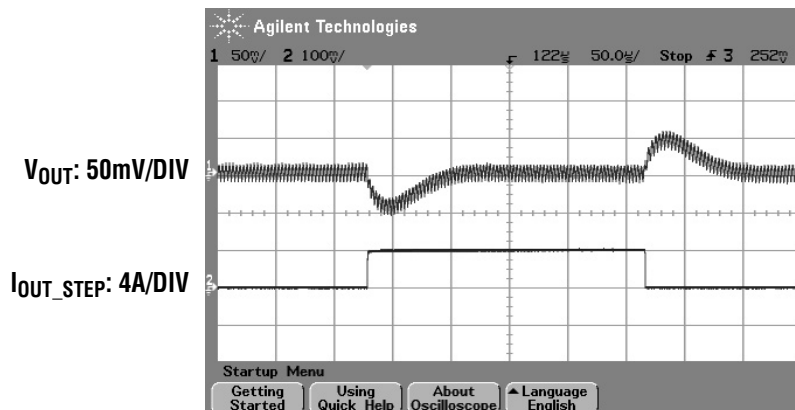

3a. $V_{IN} = 12V$, $V_O = 3.3V$, 0A to 4A Load Step

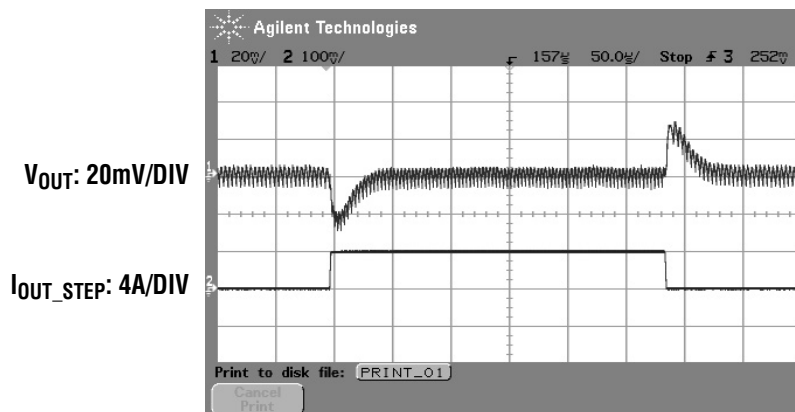

3b. $V_{IN} = 12V$, $V_O = 1.0V$, 0A to 4A Load Step

Figure 3. Measured Load Transient Responses

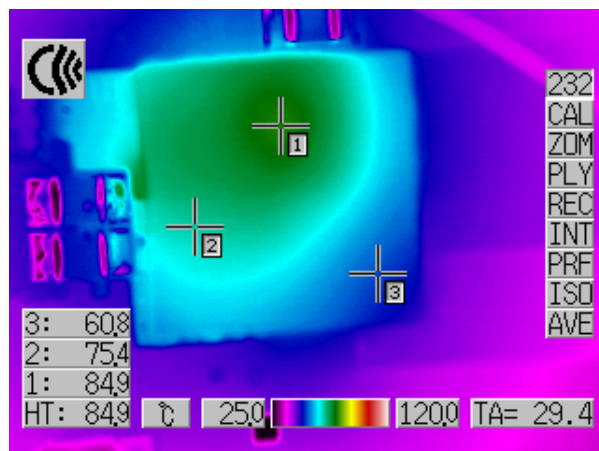

$V_{IN} = 24V$, $V_{OUT} = 6V$, $I_{LOAD} = 10A$, Ambient Temperature = 29.4°C, No Forced Air Flow

Figure 4. Thermal Image of LTM4641

DEMO MANUAL DC1543B

PARTS LIST

ITEM	QTY	REFERENCE	PART DESCRIPTION	MANUFACTURER/PART NUMBER
Required Circuit Components				
1	2	CIN2, CIN1	CAP., ALUMINUM, 100µF, 50V	SUN ELECT, 50CE100LX
2	2	CIN3, CIN4	CAP., X7R, 4.7µF, 50V, 10%, 1210	AVX, 12105C475KAT2A
3	3	CO1, CO2, CO8	CAP., POSCAP, 150µF, 10V, D3L	PANASONIC, 10TPF150ML
4	3	CO3, CO4, CO5	CAP., X7R, 47µF, 10V, 10%, 1210	AVX, 1210ZC476KAT2A
5	1	C10	CAP., X5R, 3300pF, 50V, 10%, 0603	AVX, 06035C332KAT2A
6	1	R1	RES., CHIP, 13.7k, 1/16W, 1%, 0603	VISHAY, CRCW060313K7FKEA
7	2	R5, R7	RES., CHIP, 100k, 1/16W, 1%, 0603	VISHAY, CRCW0603100KFKEA
8	2	R13, R26	RES., CHIP, 2.49k, 1/16W, ±0.1%, 0603	VISHAY, TNPW06032K49BEEA
9	1	U1	I.C., LTM4641, BGA	ANALOG DEVICES, LTM4641EY#PBF
Hardware/Components (For Demo Board Only)				
1	1	C2	CAP., X7R, 4.7µF, 25V, 10%, 0805	TDK, C2012X7R1E475K125AB
2	2	C8, C9	CAP., X5R, 8200pF, 50V, 10%, 0603	AVX, 06035C822KAT2A
3	1	R2	RES., CHIP, 680k, 1/16W, 1%, 0603	YAGEO, RC0603FR-07680KL
4	1	R15	RES., CHIP, 2.2M, 1/16W, 1%, 0603	VISHAY, CRCW06032M20FKEA
5	1	R17	RES., CHIP, 165k, 1/16W, 1%, 0603	VISHAY, CRCW0603165KFKEA
6	1	R18	RES., CHIP, 7.15k, 1/16W, 1%, 0603	VISHAY, CRCW06037K15FKEA
7	1	R19	RES., CHIP, 4.12k, 1/16W, 1%, 0603	VISHAY, CRCW06034K22FKEA
8	1	R20	RES., CHIP, 2.94k, 1/16W, 1%, 0603	VISHAY, CRCW06032K94FKEA
9	1	R21	RES., CHIP, 1.18k, 1/16W, 1%, 0603	VISHAY, CRCW06031K18FKEA
10	1	R22	RES., CHIP, 715Ω, 1/16W, 1%, 0603	VISHAY, CRCW0603715RFKEA
11	1	R23	RES., CHIP, 576Ω, 1/16W, 1%, 0603	VISHAY, CRCW0603576RFKEA
12	1	R25	RES., CHIP, 3.16k, 1/16W, 1%, 0603	VISHAY, CRCW06033K16FKEA
13	1	R28	RES., CHIP, 24.9k, 1/16W, 1%, 0603	VISHAY, CRCW060324K9FKEA
14	1	R10	RES., CHIP, 1.78M, 1/16W, 1%, 0603	VISHAY, CRCW06031M78FKEA
15	1	R24	RES., CHIP, 13k, 1/16W, 1%, 0603	VISHAY, CRCW06065K5KFKEA
16	1	R16	RES., CHIP, 1M, 1/16W, 1%, 0603	VISHAY, CRCW06031M00FKEA
17	1	R9	RES., CHIP, 187k, 1/16W, 1%, 0603	VISHAY, CRCW0603187KFKEA
18	2	R12, R8	RES., CHIP, 10Ω, 1/16W, 1%, 0603	VISHAY, CRCW060310R0FKEA
19	3	R6, R31, R34	RES., CHIP, 0Ω, 1/16W, 1%, 0603	VISHAY, CRCW06030000Z0EA
20	2	R3, R32	RES., CHIP, 10k, 1/16W, 1%, 0603	VISHAY, CRCW060310K0FKEA
21	2	RS2, RS1	RES., CHIP, 0.05Ω, 1W, 1% 2512	VISHAY, WSL2512R0500FEA
22	1	Q2	SILICON N-CHANNEL MOSFET, POWERPAK-SO8	VISHAY, SiR184DP-T1-RE3
23	1	Q3	SILICON N-CHANNEL POWER MOSFET, LPAK	NEXPERIA PSMN2R5-30YL
24	1	Q1	N-CHANNEL 40-V MOSFET, TO-252	VISHAY, SUD50N04-8M8P-4GE3
25	0	C3, C4, C5, C6, C7(OPT)	CAP, 0603	
26	0	CIN5(OPT)	CAP, 1210	
27	0	R4, R27, R29, R33, R35, R36(OPT)	RES., 0603	
28	0	R11(OPT)	RES., 1206	
29	0	D2 (OPT)	ZENER VOLTAGE REGULATOR, SOD-523	CENTRAL SEMI., CMOZ43V TR
Hardware				
1	9	JP1-JP8, JP18	2mm SINGLE ROW HEADER, 2-PIN	SAMTEC, TMM102-02-L-S
2	8	JP9-JP15, JP18	2mm SINGLE ROW HEADER, 3-PIN	SAMTEC, TMM-103-02-L-S
3	3	JP4, JP9-JP15, JP17	SHUNT	SAMTEC, 2SN-BK-G
4	2	J5, J6	CONN, BNC, 5 PINS	CONNEX, 112404
5	4	J1-J4	JACK, BANANA	KEYSTONE, 575-4
6	13	E2, E5-E8, E11, E12, E15-E20	TESTPOINT, TURRET, 0.095"	MILL-MAX, 2501-2-00-80-00-00-07-0
7	1	JP16	ULTRA-SMALL TRACTILE SWITCH	PANASONIC, EVQPE105K
8	4	STAND OFF	STAND-OFF, NYLON 0.50" tall	KEYSTONE, 8833 (SNAP ON)

SCHEMATIC DIAGRAM

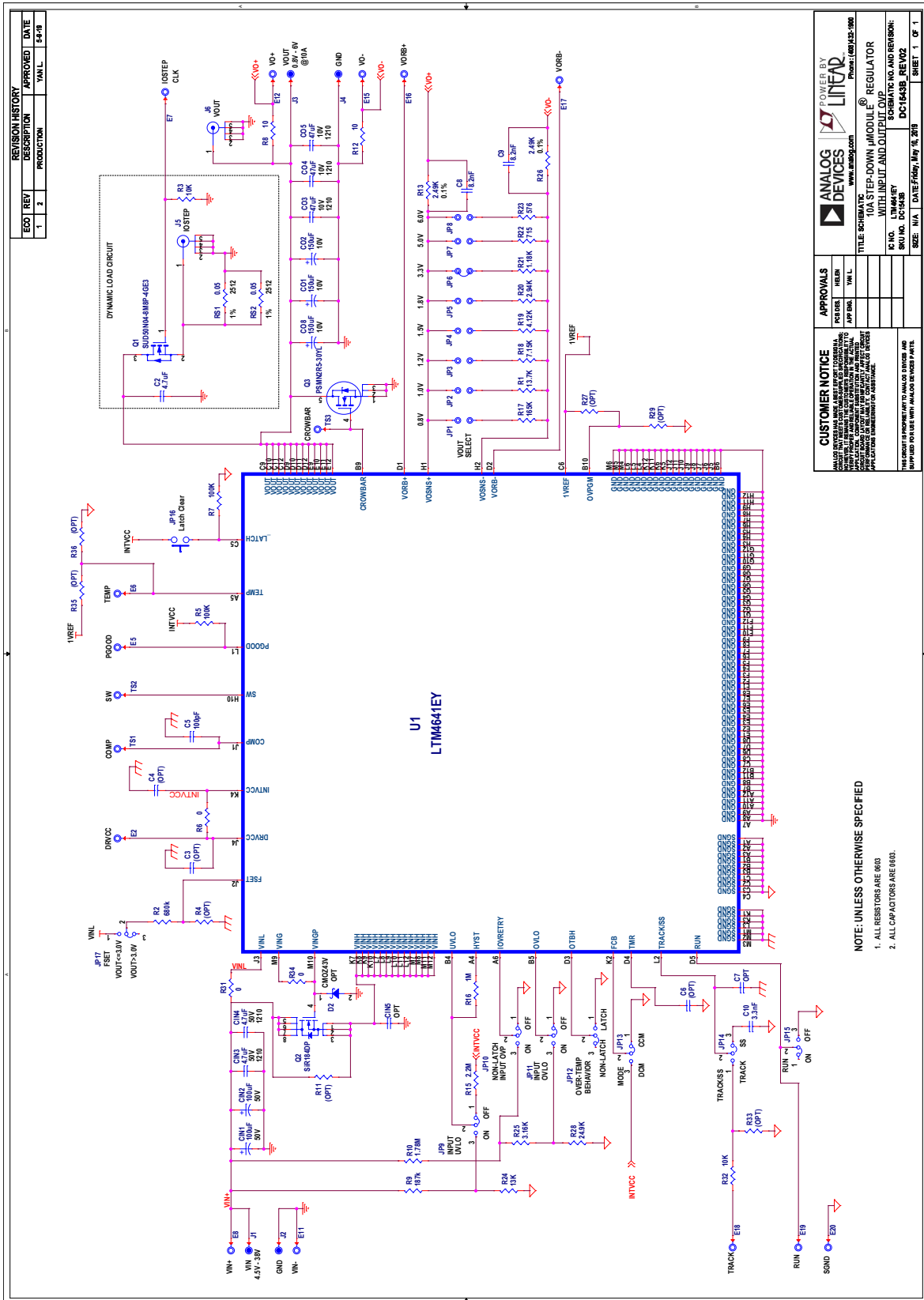

CUSTOMER NOTICE

ANALOG DEVICES AND ITS REPRESENTATIVES ASSUME NO LIABILITY FOR USE OF ANY SCHEMATIC OR INFORMATION CONTAINED HEREIN THAT IS NOT IN ACCORDANCE WITH THE SPECIFICATIONS AND TERMS OF THE LTM4641EY DATA SHEET. THE INFORMATION CONTAINED HEREIN IS PROVIDED AS A GUIDE ONLY. THE USER SHALL BE RESPONSIBLE FOR THE PROPER DESIGN AND IMPLEMENTATION OF THE SCHEMATIC.

APPROVALS

DESIGNER	DATE
APP'D	
CHK'D	
REL'D	

POWER BY ANALOG DEVICES

LINEAR

www.analog.com

Phone: (603) 251-5000

TITLE SCHEMATIC

10A STEP-DOWN MODULE REGULATOR WITH INPUT AND OUTPUT CVP

IC NO. LTM4641EY

SCHEMATIC NO. AND REVISION: DC1543B_REV02

SKU NO. DC1543B

SIZE 1/1A

DATE Friday, May 14, 2010

SHEET 1 OF 1

NOTE: UNLESS OTHERWISE SPECIFIED

1. ALL RESISTORS ARE 0603
2. ALL CAPACITORS ARE 0603



ESD Caution

ESD (electrostatic discharge) sensitive device. Charged devices and circuit boards can discharge without detection. Although this product features patented or proprietary protection circuitry, damage may occur on devices subjected to high energy ESD. Therefore, proper ESD precautions should be taken to avoid performance degradation or loss of functionality.

Legal Terms and Conditions

By using the evaluation board discussed herein (together with any tools, components documentation or support materials, the "Evaluation Board"), you are agreeing to be bound by the terms and conditions set forth below ("Agreement") unless you have purchased the Evaluation Board, in which case the Analog Devices Standard Terms and Conditions of Sale shall govern. Do not use the Evaluation Board until you have read and agreed to the Agreement. Your use of the Evaluation Board shall signify your acceptance of the Agreement. This Agreement is made by and between you ("Customer") and Analog Devices, Inc. ("ADI"), with its principal place of business at One Technology Way, Norwood, MA 02062, USA. Subject to the terms and conditions of the Agreement, ADI hereby grants to Customer a free, limited, personal, temporary, non-exclusive, non-sublicensable, non-transferable license to use the Evaluation Board FOR EVALUATION PURPOSES ONLY. Customer understands and agrees that the Evaluation Board is provided for the sole and exclusive purpose referenced above, and agrees not to use the Evaluation Board for any other purpose. Furthermore, the license granted is expressly made subject to the following additional limitations: Customer shall not (i) rent, lease, display, sell, transfer, assign, sublicense, or distribute the Evaluation Board; and (ii) permit any Third Party to access the Evaluation Board. As used herein, the term "Third Party" includes any entity other than ADI, Customer, their employees, affiliates and in-house consultants. The Evaluation Board is NOT sold to Customer; all rights not expressly granted herein, including ownership of the Evaluation Board, are reserved by ADI. CONFIDENTIALITY. This Agreement and the Evaluation Board shall all be considered the confidential and proprietary information of ADI. Customer may not disclose or transfer any portion of the Evaluation Board to any other party for any reason. Upon discontinuation of use of the Evaluation Board or termination of this Agreement, Customer agrees to promptly return the Evaluation Board to ADI. ADDITIONAL RESTRICTIONS. Customer may not disassemble, decompile or reverse engineer chips on the Evaluation Board. Customer shall inform ADI of any occurred damages or any modifications or alterations it makes to the Evaluation Board, including but not limited to soldering or any other activity that affects the material content of the Evaluation Board. Modifications to the Evaluation Board must comply with applicable law, including but not limited to the RoHS Directive. TERMINATION. ADI may terminate this Agreement at any time upon giving written notice to Customer. Customer agrees to return to ADI the Evaluation Board at that time. LIMITATION OF LIABILITY. THE EVALUATION BOARD PROVIDED HEREUNDER IS PROVIDED "AS IS" AND ADI MAKES NO WARRANTIES OR REPRESENTATIONS OF ANY KIND WITH RESPECT TO IT. ADI SPECIFICALLY DISCLAIMS ANY REPRESENTATIONS, ENDORSEMENTS, GUARANTEES, OR WARRANTIES, EXPRESS OR IMPLIED, RELATED TO THE EVALUATION BOARD INCLUDING, BUT NOT LIMITED TO, THE IMPLIED WARRANTY OF MERCHANTABILITY, TITLE, FITNESS FOR A PARTICULAR PURPOSE OR NON-INFRINGEMENT OF INTELLECTUAL PROPERTY RIGHTS. IN NO EVENT WILL ADI AND ITS LICENSORS BE LIABLE FOR ANY INCIDENTAL, SPECIAL, INDIRECT, OR CONSEQUENTIAL DAMAGES RESULTING FROM CUSTOMER'S POSSESSION OR USE OF THE EVALUATION BOARD, INCLUDING BUT NOT LIMITED TO LOST PROFITS, DELAY COSTS, LABOR COSTS OR LOSS OF GOODWILL. ADI'S TOTAL LIABILITY FROM ANY AND ALL CAUSES SHALL BE LIMITED TO THE AMOUNT OF ONE HUNDRED US DOLLARS (\$100.00). EXPORT. Customer agrees that it will not directly or indirectly export the Evaluation Board to another country, and that it will comply with all applicable United States federal laws and regulations relating to exports. GOVERNING LAW. This Agreement shall be governed by and construed in accordance with the substantive laws of the Commonwealth of Massachusetts (excluding conflict of law rules). Any legal action regarding this Agreement will be heard in the state or federal courts having jurisdiction in Suffolk County, Massachusetts, and Customer hereby submits to the personal jurisdiction and venue of such courts. The United Nations Convention on Contracts for the International Sale of Goods shall not apply to this Agreement and is expressly disclaimed.