

Data sheet | Item number: 880-687/999-940

3-conductor ground terminal block; 4 mm²; side and center marking; for DIN-rail 35 x 15 and 35 x 7.5; CAGE CLAMP®; 4,00 mm²; green-yellow

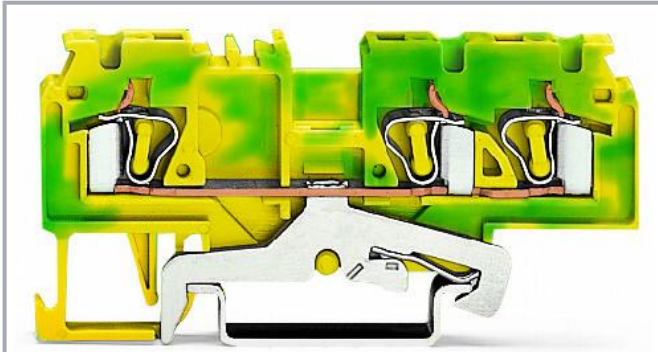

www.wago.com/880-687/999-940



 Picture differs from the item.

Color: 

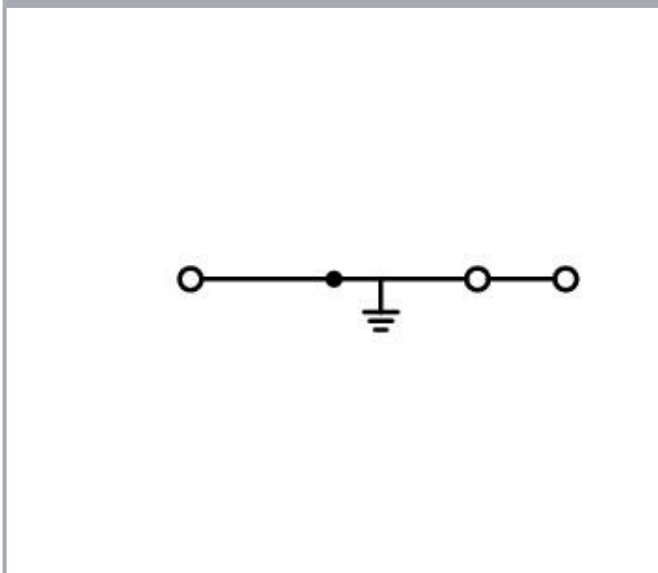
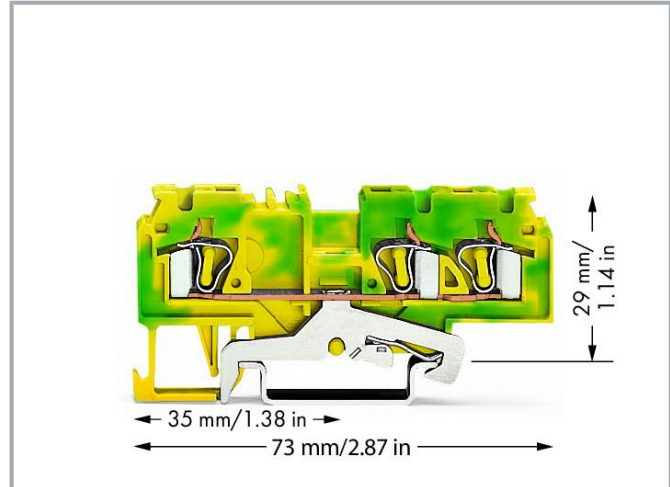

Data Electrical data

Subject to changes. Please also observe the further product documentation!

WAGO GmbH & Co. KG
Hansastr. 27
32423 Minden
Phone: +49571 887-0 | Fax: +49571 887-169
Email: info.de@wago.com | Web: www.wago.com

Do you have any questions about our products?
We are always happy to take your call at +49 (571) 887-44222.



Ratings per IEC/EN

Ratings per	IEC/EN 60947-7-2
-------------	------------------

Connection data

Connection points	3
Total number of potentials	1
Number of levels	1

Connection 1

Connection technology	CAGE CLAMP®
Actuation type	Operating tool
Connectable conductor materials	Copper
Solid conductor	0.08 ... 4 mm ² / 28 ... 12 AWG
Fine-stranded conductor	0.08 ... 4 mm ² / 28 ... 12 AWG
Strip length	8 ... 9 mm / 0.31 ... 0.35 inches
Wiring direction	Front-entry wiring

Physical data

Width	5 mm / 0.197 inches
Height	73 mm / 2.874 inches
Depth from upper-edge of DIN-rail	29 mm / 1.142 inches

Mechanical Data

Design	horizontal type
Mounting type	DIN-35 rail
Marking level	Center/side marking

Material Data

Note (material data)	Information on material specifications can be found here
Color	green-yellow
Material group	I
Insulation material	Polyamide (PA66)
Flammability class per UL94	V0

Subject to changes. Please also observe the further product documentation!



Fire load	0.12 MJ
Weight	11.9 g

Environmental requirements

Processing temperature	-35 ... +85 °C
Continuous operating temperature	-60 ... +105 °C

Commercial data

eCl@ss 10.0	27-14-11-41
eCl@ss 9.0	27-14-11-41
ETIM 8.0	EC000901
ETIM 7.0	EC000901
PU (SPU)	100 pcs
Packaging type	box
Country of origin	DE
GTIN	4045454084783
Customs tariff number	85369010000

Environmental Product Compliance

CAS-No.	7439-92-1
REACH Candidate List Substance	Lead
RoHS Compliance Status	Compliant,With Exemption
RoHS Exemption	6(c) 7(a) 7(c)-I 7(c)-II
SCIP notification number (Austria)	c29ebeda-8163-4ab1-8428-744bac13f879
SCIP notification number (Belgium)	67b682d6-b91f-436d-bfec-af9642e8cb7d
SCIP notification number (Bulgaria)	6254fd7d-62d1-45dd-bcb6-97076e23ea07
SCIP notification number (Czech Republic)	f4d12b5a-510f-4458-b0b0-19601eca407f
SCIP notification number (Denmark)	edcbdb7e-bd37-483c-a369-c36e1edd2d0f
SCIP notification number (Finland)	c48d6e32-3ece-4a29-bd8a-99a4bc5f35bb
SCIP notification number (France)	4c1daab8-c188-41b5-b9b3-cd3d3556fbd5
SCIP notification number (Germany)	3d74a072-b4ee-4292-8236-a6829fc2cbaf
SCIP notification number (Hungary)	f416f477-a785-49a3-834f-f49eee7df3dd
SCIP notification number (Italy)	39e33a73-d746-4d3f-8bbf-426942bfaa0f
SCIP notification number (Netherlands)	0f5deae2-4baa-41a9-b96b-105d349d73bd

Subject to changes. Please also observe the further product documentation!



WAGO GmbH & Co. KG
 Hansastr. 27
 32423 Minden
 Phone: +49571 887-0 | Fax: +49571 887-169
 Email: info.de@wago.com | Web: www.wago.com

Do you have any questions about our products?
 We are always happy to take your call at +49 (571) 887-44222.



SCIP notification number (Poland)	149b10a5-bddf-4dcc-b373-5d44cda0767e
SCIP notification number (Romania)	6d0eedbd-0b1b-408a-891a-d77fd360bc01
SCIP notification number (Sweden)	0673d051-a1ff-4b80-abb6-4c8bf239e5a9

Approvals / Certificates

General approvals

Logo	Approval	Additional Approval Text	Certificate name
	CCA DEKRA Certification B.V.	EN 60947	NTR-NL 7339
	CCA DEKRA Certification B.V.	EN 60947	2174152.01
	UL Underwriters Laboratories Inc.	UL 1059	E45172

Declarations of conformity and manufacturer's declarations

Logo	Approval	Additional Approval Text	Certificate name
	EU-Declaration of Conformity WAGO GmbH & Co. KG	-	-
	UK-Declaration of Conformity WAGO GmbH & Co. KG	-	-

Approvals for marine applications

Logo	Approval	Additional Approval Text	Certificate name
	ABS American Bureau of Shipping	EN 60947	20- HG1941090- PDA
	DNV GL Det Norske Veritas, Germanischer Lloyd	-	TAE00001V2

Subject to changes. Please also observe the further product documentation!





Approvals for hazardous areas

Logo	Approval	Additional Approval Text	Certificate name
	EAC Brjansker Zertifizierungsstelle	TP TC 012/2011	RU C-DE. AM02.B. 00127/19 (Ex e IIC Gb U)

Required accessories

End plate



End plate		
	Item no.: 880-308 End and intermediate plate; 2.5 mm thick; gray	www.wago.com/880-308
	Item no.: 880-339 End and intermediate plate; 2.5 mm thick; orange	www.wago.com/880-339

Optional accessories













Ferrule

Ferrule		
	Item no.: 216-206 Ferrule; Sleeve for 2.5 mm ² / AWG 14; insulated; electro-tin plated; blue	www.wago.com/216-206

Marking accessories

Marker		
	Item no.: 2009-115/000-002 WMB-Inline; for Smart Printer; 1500 pieces on roll; stretchable 5 - 5.2 mm; plain; snap-on type; yellow	www.wago.com/2009-115/000-002
	Item no.: 2009-115/000-007 WMB-Inline; for Smart Printer; 1500 pieces on roll; stretchable 5 - 5.2 mm; plain; snap-on type; gray	www.wago.com/2009-115/000-007
	Item no.: 2009-115/000-017 WMB-Inline; for Smart Printer; 1500 pieces on roll; stretchable 5 - 5.2 mm; plain; snap-on type; light green	www.wago.com/2009-115/000-017

Subject to changes. Please also observe the further product documentation!

	Item no.: 2009-115/000-023 WMB-Inline; for Smart Printer; 1500 pieces on roll; stretchable 5 - 5.2 mm; plain; snap-on type; green	www.wago.com/2009-115/000-023
	Item no.: 2009-115/000-024 WMB-Inline; for Smart Printer; 1500 pieces on roll; stretchable 5 - 5.2 mm; plain; snap-on type; violet	www.wago.com/2009-115/000-024
	Item no.: 2009-145/000-006 Mini-WSB Inline; for Smart Printer; 1700 pieces on roll; stretchable 5 - 5.2 mm; plain; snap-on type; blue	www.wago.com/2009-145/000-006
	Item no.: 2009-145 Mini-WSB Inline; for Smart Printer; 1700 pieces on roll; stretchable 5 - 5.2 mm; plain; snap-on type; white	www.wago.com/2009-145
	Item no.: 2009-145/000-002 Mini-WSB Inline; for Smart Printer; 1700 pieces on roll; stretchable 5 - 5.2 mm; plain; snap-on type; yellow	www.wago.com/2009-145/000-002
	Item no.: 2009-145/000-007 Mini-WSB Inline; for Smart Printer; 1700 pieces on roll; stretchable 5 - 5.2 mm; plain; snap-on type; gray	www.wago.com/2009-145/000-007
	Item no.: 2009-145/000-005 Mini-WSB Inline; for Smart Printer; 1700 pieces on roll; stretchable 5 - 5.2 mm; plain; snap-on type; red	www.wago.com/2009-145/000-005
	Item no.: 2009-145/000-012 Mini-WSB Inline; for Smart Printer; 1700 pieces on roll; stretchable 5 - 5.2 mm; plain; snap-on type; orange	www.wago.com/2009-145/000-012
	Item no.: 2009-145/000-023 Mini-WSB Inline; for Smart Printer; 1700 pieces on roll; stretchable 5 - 5.2 mm; plain; snap-on type; green	www.wago.com/2009-145/000-023
	Item no.: 2009-145/000-024 Mini-WSB Inline; for Smart Printer; 1700 pieces on roll; stretchable 5 - 5.2 mm; plain; snap-on type; violet	www.wago.com/2009-145/000-024
	Item no.: 2009-115 WMB-Inline; for Smart Printer; 1500 pieces on roll; stretchable 5 - 5.2 mm; plain; snap-on type; white	www.wago.com/2009-115
	Item no.: 248-501/000-006 Mini-WSB marking card; as card; not stretchable; plain; snap-on type; blue	www.wago.com/248-501/000-006
	Item no.: 248-501/000-007 Mini-WSB marking card; as card; not stretchable; plain; snap-on type; gray	www.wago.com/248-501/000-007

Subject to changes. Please also observe the further product documentation!



Item no.: 248-501/000-002

Mini-WSB marking card; as card; not stretchable; plain; snap-on type; yellow

www.wago.com/248-501/000-002



Item no.: 248-501/000-012

Mini-WSB marking card; as card; not stretchable; plain; snap-on type; orange

www.wago.com/248-501/000-012



Item no.: 248-501

Mini-WSB marking card; as card; not stretchable; plain; snap-on type; white

www.wago.com/248-501



Item no.: 248-501/000-017

Mini-WSB marking card; as card; not stretchable; plain; snap-on type; light green

www.wago.com/248-501/000-017



Item no.: 248-501/000-005

Mini-WSB marking card; as card; not stretchable; plain; snap-on type; red

www.wago.com/248-501/000-005



Item no.: 248-501/000-024

Mini-WSB marking card; as card; not stretchable; plain; snap-on type; violet

www.wago.com/248-501/000-024



Item no.: 248-501/000-023

Mini-WSB marking card; as card; not stretchable; plain; snap-on type; green

www.wago.com/248-501/000-023



Item no.: 793-5501/000-007

WMB marking card; as card; for terminal block width 5 - 17.5 mm; stretchable 5 - 5.2 mm; plain; snap-on type; gray

www.wago.com/793-5501/000-007

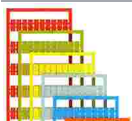

Item no.: 793-5501/000-012

WMB marking card; as card; for terminal block width 5 - 17.5 mm; stretchable 5 - 5.2 mm; plain; snap-on type; orange

www.wago.com/793-5501/000-012

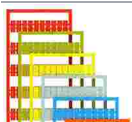

Item no.: 793-5501/000-017

WMB marking card; as card; for terminal block width 5 - 17.5 mm; stretchable 5 - 5.2 mm; plain; snap-on type; light green

www.wago.com/793-5501/000-017



Item no.: 793-5501/000-023

WMB marking card; as card; for terminal block width 5 - 17.5 mm; stretchable 5 - 5.2 mm; plain; snap-on type; green

www.wago.com/793-5501/000-023

Subject to changes. Please also observe the further product documentation!

WAGO GmbH & Co. KG

Hansastr. 27

32423 Minden

Phone: +49571 887-0 | Fax: +49571 887-169

Email: info.de@wago.com | Web: www.wago.com

Do you have any questions about our products?

We are always happy to take your call at +49 (571) 887-44222.



Item no.: 793-5501/000-024

WMB marking card; as card; for terminal block width 5 - 17.5 mm; stretchable 5 - 5.2 mm; plain; snap-on type; violet

www.wago.com/793-5501/000-024



Item no.: 793-501/000-002

WMB marking card; as card; not stretchable; plain; snap-on type; yellow

www.wago.com/793-501/000-002



Item no.: 793-501/000-007

WMB marking card; as card; not stretchable; plain; snap-on type; gray

www.wago.com/793-501/000-007



Item no.: 793-501/000-017

WMB marking card; as card; not stretchable; plain; snap-on type; light green

www.wago.com/793-501/000-017



Item no.: 793-501/000-012

WMB marking card; as card; not stretchable; plain; snap-on type; orange

www.wago.com/793-501/000-012



Item no.: 793-501/000-023

WMB marking card; as card; not stretchable; plain; snap-on type; green

www.wago.com/793-501/000-023



Item no.: 793-501/000-006

WMB marking card; as card; not stretchable; plain; snap-on type; blue

www.wago.com/793-501/000-006



Item no.: 793-501/000-005

WMB marking card; as card; not stretchable; plain; snap-on type; red

www.wago.com/793-501/000-005



Item no.: 793-501

WMB marking card; as card; not stretchable; plain; snap-on type; white

www.wago.com/793-501



Item no.: 793-501/000-024

WMB marking card; as card; not stretchable; plain; snap-on type; violet

www.wago.com/793-501/000-024

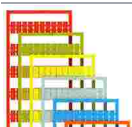

Item no.: 793-5501/000-005

WMB marking card; as card; for terminal block width 5 - 17.5 mm; stretchable 5 - 5.2 mm; plain; snap-on type; red

www.wago.com/793-5501/000-005

Subject to changes. Please also observe the further product documentation!

WAGO GmbH & Co. KG

Hansastr. 27

32423 Minden

Phone: +49571 887-0 | Fax: +49571 887-169

Email: info.de@wago.com | Web: www.wago.com

Do you have any questions about our products?

We are always happy to take your call at +49 (571) 887-44222.



Item no.: 793-5501/000-002

WMB marking card; as card; for terminal block width 5 - 17.5 mm; stretchable 5 - 5.2 mm; plain; snap-on type; yellow

www.wago.com/793-5501/000-002



Item no.: 793-5501/000-006

WMB marking card; as card; for terminal block width 5 - 17.5 mm; stretchable 5 - 5.2 mm; plain; snap-on type; blue

www.wago.com/793-5501/000-006



Item no.: 793-5501

WMB marking card; as card; for terminal block width 5 - 17.5 mm; stretchable 5 - 5.2 mm; plain; snap-on type; white

www.wago.com/793-5501



Item no.: 2009-115/000-012

WMB-Inline; for Smart Printer; 1500 pieces on roll; stretchable 5 - 5.2 mm; plain; snap-on type; orange

www.wago.com/2009-115/000-012



Item no.: 2009-115/000-006

WMB-Inline; for Smart Printer; 1500 pieces on roll; stretchable 5 - 5.2 mm; plain; snap-on type; blue

www.wago.com/2009-115/000-006

Group marker carrier



Item no.: 249-105

Group marker carrier; gray

www.wago.com/249-105

Jumpers

Jumper



Item no.: 210-123

Wire commoning chain; insulated; blue

www.wago.com/210-123



Item no.: 280-402

Jumper; insulated; gray

www.wago.com/280-402



Item no.: 210-103

Wire commoning chain; insulated; black

www.wago.com/210-103



Item no.: 280-409

Jumper; insulated; gray

www.wago.com/280-409



Item no.: 280-422

Jumper; insulated; yellow-green

www.wago.com/280-422



Item no.: 709-110

Wire commoning chain; 2.5 mm²; insulated; black

www.wago.com/709-110



Item no.: 709-112

Wire commoning chain; 2.5 mm²; insulated; black

www.wago.com/709-112

Subject to changes. Please also observe the further product documentation!

WAGO GmbH & Co. KG

Hansastr. 27

32423 Minden

Phone: +49571 887-0 | Fax: +49571 887-169

Email: info.de@wago.com | Web: www.wago.com

Do you have any questions about our products?

We are always happy to take your call at +49 (571) 887-44222.



Item no.: 709-111
Wire commoning chain; 2.5 mm²; insulated; black

www.wago.com/709-111



Item no.: 780-454
Staggered jumper; from 1 to 4; insulated; gray

www.wago.com/780-454



Item no.: 780-452
Staggered jumper; from 1 to 2; insulated; gray

www.wago.com/780-452



Item no.: 780-453
Staggered jumper; from 1 to 3; insulated; gray

www.wago.com/780-453



Item no.: 780-457
Staggered jumper; from 1 to 7; insulated; gray

www.wago.com/780-457



Item no.: 780-456
Staggered jumper; from 1 to 6; insulated; gray

www.wago.com/780-456



Item no.: 780-455
Staggered jumper; from 1 to 5; insulated; gray

www.wago.com/780-455



Item no.: 780-458
Staggered jumper; from 1 to 8; insulated; gray

www.wago.com/780-458

Protective warning marker

Cover



Item no.: 280-415
Protective warning marker; for 5 terminal blocks; with high-voltage symbol, black; yellow

www.wago.com/280-415

Push-in type wire jumper

Jumper



Item no.: 249-123
Push-in type wire jumper; 0.75 mm²; insulated; 180 mm long; black

www.wago.com/249-123



Item no.: 249-126
Push-in type wire jumper; 0.75 mm²; insulated; 110 mm long; black

www.wago.com/249-126



Item no.: 249-127
Push-in type wire jumper; 0.75 mm²; insulated; 250 mm long; black

www.wago.com/249-127



Item no.: 249-125
Push-in type wire jumper; insulated; 60 mm long; black

www.wago.com/249-125

Mounting

Cover carrier



Item no.: 709-167
Cover carrier; Type 1; incl. fixing/retaining screws and knurled nut; suitable for 279 to 282 and 880 Series rail-mounted terminal blocks; suitable for 264 Series miniature rail-mounted terminal blocks; suitable for 270 Series sensor and actuator terminal blocks; gray

www.wago.com/709-167

Cover

Subject to changes. Please also observe the further product documentation!



Item no.: 709-153
Cover; Type 1; suitable for cover carrier, type 1; 1 m long; transparent

www.wago.com/709-153

Mounting accessories



Item no.: 209-106
Mounting carrier; for isolated mounting on DIN 35 rails; gray

www.wago.com/209-106



Item no.: 249-116
Screwless end stop; 6 mm wide; for DIN-rail 35 x 15 and 35 x 7.5; gray

www.wago.com/249-116

Testing and measuring

Testing accessories



Item no.: 209-170
Test plug adapter; 8.3 mm wide; for 4 mm Ø test plugs; suitable for 1.5 mm² - 10 mm² tbs; gray

www.wago.com/209-170



Item no.: 210-136
Test plug; 2 mm Ø; with 500 mm cable; red

www.wago.com/210-136



Item no.: 281-407
Test plug; 6 mm wide; Nominal current 24 A; for 0.08 mm² - 2.5 mm²; 2,50 mm²; gray

www.wago.com/281-407



Item no.: 249-106
B-type test plug module; modular; 1,50 mm²; gray

www.wago.com/249-106



Item no.: 249-107
B-type spacer module; modular; e.g., for bridging commoned terminal blocks; gray

www.wago.com/249-107



Item no.: 280-418
Test plug module; modular; suitable for all WAGO 280 and 780 Series rail-mounted terminal blocks with jumper slots in the current bar; gray

www.wago.com/280-418



Item no.: 280-404
Test plug adapter; 5 mm wide; for test plug (2.3 mm Ø); suitable for 1.5 mm² - 4 mm² tbs; gray

www.wago.com/280-404



Item no.: 280-419
Spacer module; modular; bridging commoned terminal blocks; gray

www.wago.com/280-419

Carrier rail

Mounting accessories



Item no.: 210-197
Steel carrier rail; 35 x 15 mm; 1.5 mm thick; 2 m long; slotted; similar to EN 60715; silver-colored

www.wago.com/210-197



Item no.: 210-198
Copper carrier rail; 35 x 15 mm; 2.3 mm thick; 2 m long; unslotted; according to EN 60715; copper-colored









www.wago.com/210-198



Item no.: 210-504
Steel carrier rail; 35 x 7.5 mm; 1 mm thick; 2 m long; slotted; galvanized; according to EN 60715; silver-colored

www.wago.com/210-504

Subject to changes. Please also observe the further product documentation!

	Item no.: 210-505 Steel carrier rail; 35 x 7.5 mm; 1 mm thick; 2 m long; unslotted; galvanized; according to EN 60715; silver-colored	www.wago.com/210-505
	Item no.: 210-506 Steel carrier rail; 35 x 15 mm; 1.5 mm thick; 2 m long; unslotted; galvanized; similar to EN 60715; silver-colored	www.wago.com/210-506
	Item no.: 210-508 Steel carrier rail; 35 x 15 mm; 1.5 mm thick; 2 m long; slotted; galvanized; similar to EN 60715; silver-colored	www.wago.com/210-508
	Item no.: 210-113 Steel carrier rail; 35 x 7.5 mm; 1 mm thick; 2 m long; unslotted; according to EN 60715; silver-colored	www.wago.com/210-113
	Item no.: 210-118 Steel carrier rail; 35 x 15 mm; 2.3 mm thick; 2 m long; unslotted; according to EN 60715; silver-colored	www.wago.com/210-118
	Item no.: 210-112 Steel carrier rail; 35 x 7.5 mm; 1 mm thick; 2 m long; slotted; according to EN 60715; "Hole width 25 mm; silver-colored	www.wago.com/210-112
	Item no.: 210-114 Steel carrier rail; 35 x 15 mm; 1.5 mm thick; 2 m long; unslotted; similar to EN 60715; silver-colored	www.wago.com/210-114
	Item no.: 210-115 Steel carrier rail; 35 x 7.5 mm; 1 mm thick; 2 m long; slotted; according to EN 60715; "Hole width 18 mm; silver-colored	www.wago.com/210-115
	Item no.: 210-196 Aluminum carrier rail; 35 x 8.2 mm; 1.6 mm thick; 2 m long; unslotted; similar to EN 60715; silver-colored	www.wago.com/210-196
End plate		
End plate		
	Item no.: 880-340 Separator plate; 2 mm thick; oversized; orange	www.wago.com/880-340
	Item no.: 880-309 Separator plate; 2 mm thick; oversized; gray	www.wago.com/880-309
Insulation stop		
Insulation stop		
	Item no.: 280-472 Insulation stop; 0.75 - 1 mm ² ; 5 pieces/strip; black	www.wago.com/280-472
	Item no.: 280-470 Insulation stop; 0.08 - 0.2 mm ² "s" (0.14 mm ² "f-st"); 5 pieces/strip; white	www.wago.com/280-470
	Item no.: 280-471 Insulation stop; 0.25 - 0.5 mm ² ; 5 pieces/strip; light gray	www.wago.com/280-471

Subject to changes. Please also observe the further product documentation!



Downloads Documentation

Bid Text

880-687/999-940 X81 - Datei	2019 Feb 19	xml 3.3 kB	Download
--------------------------------	-------------	---------------	----------

880-687/999-940 doc - Datei	2017 Feb 28	doc 24.6 kB	Download
--------------------------------	-------------	----------------	----------

Additional Information

Technical Section Technical explanations		pdf 2.2 MB	Download
---------------------------------------------	--	---------------	----------

CAD/CAE-Data

CAD data

2D/3D Models 880-687/999-940		URL	Download
------------------------------	--	-----	----------

CAE data

EPLAN Data Portal 880-687/999-940		URL	Download
-----------------------------------	--	-----	----------

WSCAD Universe 880-687/999-940		URL	Download
--------------------------------	--	-----	----------

ZUKEN Portal 880-687/999-940		URL	Download
------------------------------	--	-----	----------

EPLAN Data Portal 880-687/999-940		URL	Download
-----------------------------------	--	-----	----------

WSCAD Universe 880-687/999-940		URL	Download
--------------------------------	--	-----	----------

Environmental Product Compliance

Compliance Search

Environmental Product Compliance 880-687/999-940		URL	Download
--------------------------------------------------	--	-----	----------

3-conductor ground terminal block; 4 mm²; side and center marking; for DIN-rail 35 x 15 and 35 x 7.5; CAGE CLAMP®; 4,00 mm²; green-yellow

Subject to changes. Please also observe the further product documentation!

Installation Notes

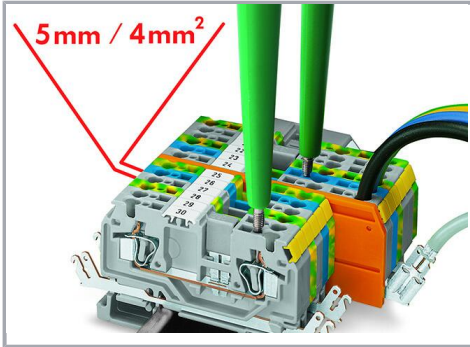

Features

- 2-, 3- and 4-conductor terminal blocks, just 5 mm wide
- Conductor cross-sections up to 4 mm² (per VDE 0281) or 12 AWG with ferrule (Item No. 216-206) 2.5 mm² rubber-insulated conductors with outer diameter up to 4.4 mm
- Shield contact via 6.3 (2 x 2.8) mm solder/crimp quick disconnect terminal
- Test plug, red, 2 mm Ø
- WMB markers
- Mini-WSB markers, on both sides
- Commoning with WAGO jumper systems

Testing

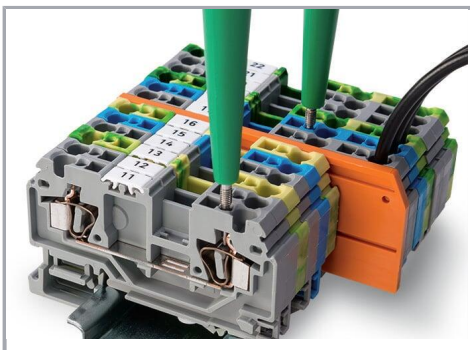

880 Series Terminal Blocks have an additional test slot for voltage tester.

Subject to changes. Please also observe the further product documentation!



Product family

Classic

EPSITRON® CLASSIC POWER: The Robust Power Supply – with Integrated TopBoost (Optional)

[Show all products from the family](#)

Subject to changes. Please also observe the further product documentation!

WAGO GmbH & Co. KG

Hansastr. 27

32423 Minden

Phone: +49571 887-0 | Fax: +49571 887-169

Email: info.de@wago.com | Web: www.wago.com

Do you have any questions about our products?

We are always happy to take your call at +49 (571) 887-44222.