

Automotive Ferrite Chip Beads



AFBC-Q0805

Request Samples



Check Inventory



2.00 x 1.25 x 0.85 mm
RoHS/RoHS II Compliant
MSL Level = 1

Features

- AEC-Q200 Qualified
- Operating Temperature: -55 ~ +150°C
- Wide range impedance
- Monolithic inorganic material construction
- Excellent heat resistance

Applications

- Electronic control Units (ECUs)
- RF transceiver modules
- Antennas
- Infotainment system
- ADAS
- Industrial connectivity (IIoT)

Electrical Specifications

Part Number	Impedance	DC Resistance	Rated Current
Units	$\Omega \pm 25\%$	Ω Max.	mA Max.
Symbol	Z	R _{DC}	I _R
AFBC-Q0805-110-T	11	0.10	900
AFBC-Q0805-170-T	17	0.10	600
AFBC-Q0805-260-T	26	0.10	600
AFBC-Q0805-300-T	30	0.10	600
AFBC-Q0805-400-T	40	0.10	600
AFBC-Q0805-600-T	60	0.10	900
AFBC-Q0805-121-T	120	0.20	800
AFBC-Q0805-151-T	150	0.20	800
AFBC-Q0805-221-T	220	0.30	750
AFBC-Q0805-301-T	300	0.30	700
AFBC-Q0805-471-T	470	0.35	700
AFBC-Q0805-601-T	600	0.40	500
AFBC-Q0805-102-T	1000	0.45	400
AFBC-Q0805-152-T	1500	0.50	350
AFBC-Q0805-202-T	2000	0.60	250

Test Conditions and Equipment

Impedance Test Frequency: 100MHz

IR: Rated current applied when the chip surface temperature rise just 20°C against chip surface temperature.

Operating Temperature: -55°C to +150°C (Including self-temperature rise)

Storage Temperature: <+40°C and RH 60% (Max).

AFBC-Q0805 is **RoHS Compliant and Pb free**



5101 Hidden Creek Ln Spicewood TX 78669
Phone: 512-371-6159 | Fax: 512-351-8858
For terms and conditions of sales, please visit:
www.abracon.com

REVISION: IR 08-10-22

ABRACON IS
ISO9001-2015
CERTIFIED

Automotive Ferrite Chip Beads



AFBC-Q0805

Request Samples



Check Inventory



2.00 x 1.25 x 0.85 mm
RoHS/RoHS II Compliant
MSL Level = 1

Electrical Specifications (Cont'd)

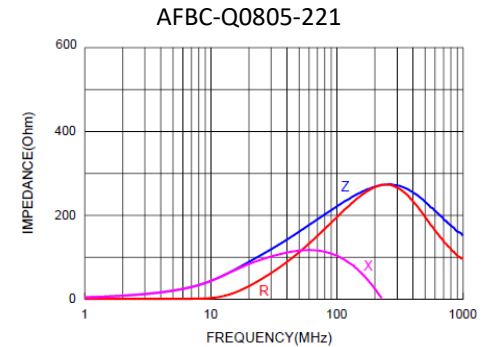
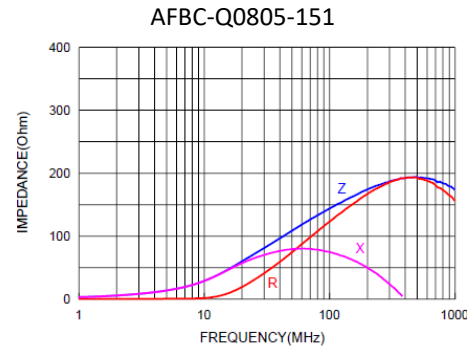
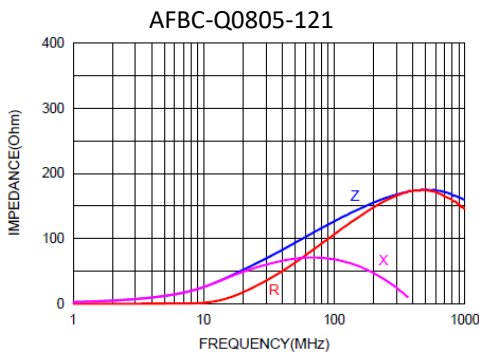
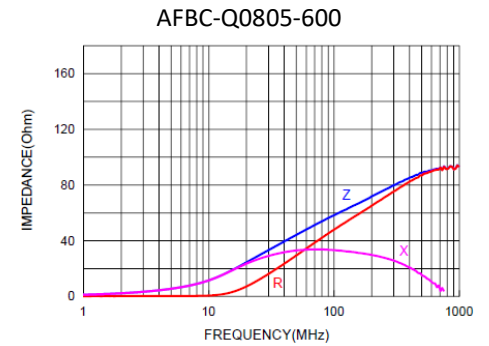
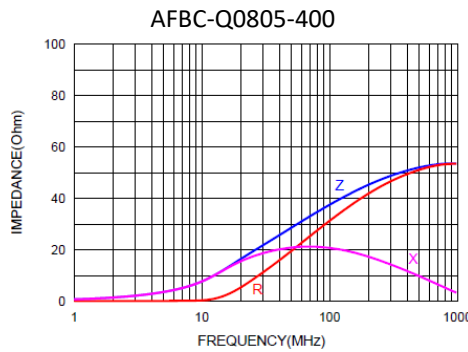
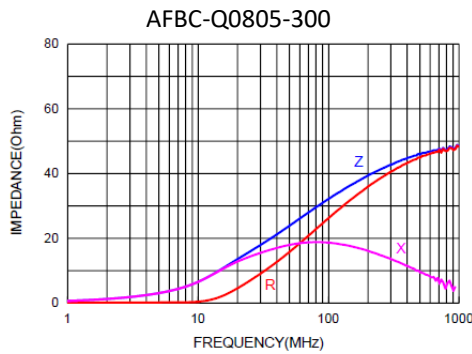
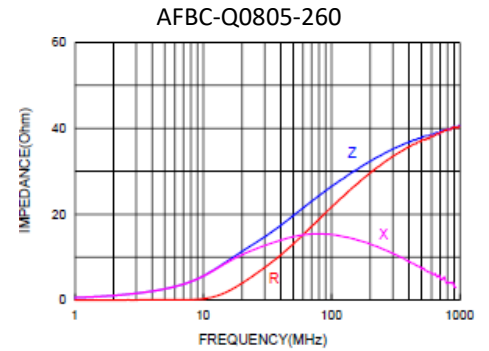
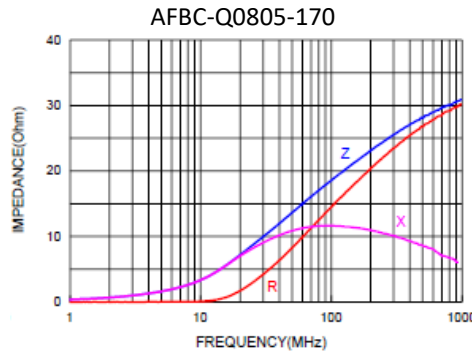
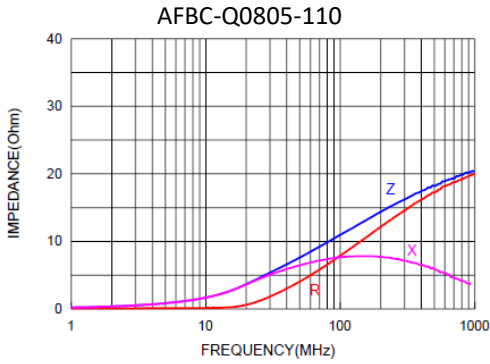

Automotive Ferrite Chip Beads

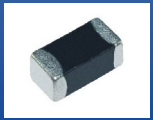

AFBC-Q0805

Request Samples



Check Inventory



2.00 x 1.25 x 0.85 mm
RoHS/RoHS II Compliant
MSL Level = 1

Electrical Specifications (Cont'd)

AFBC-Q0805-301

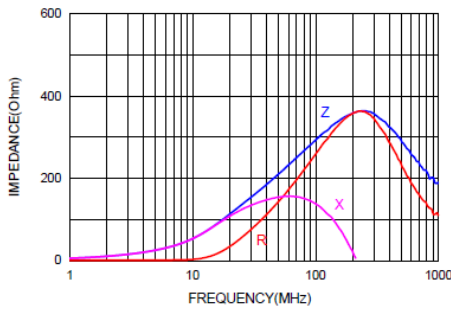

AFBC-Q0805-471

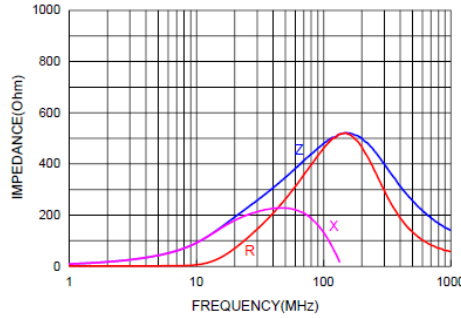

AFBC-Q0805-601

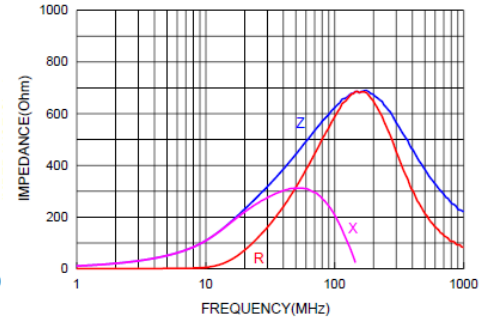

AFBC-Q0805-102

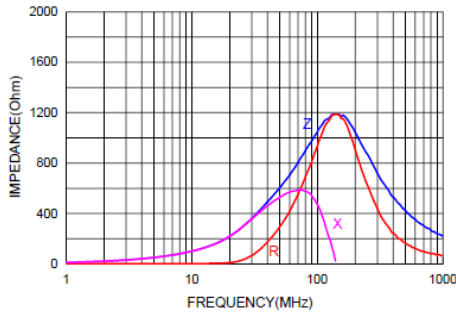

AFBC-Q0805-152

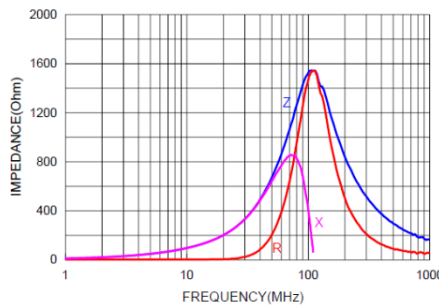

AFBC-Q0805-202

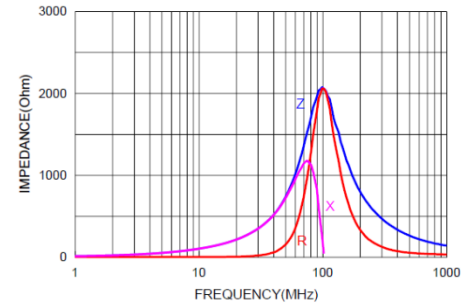

Part Number Identification

AFBC - Q0805 - -

Impedance Code

Please refer to the Electrical Specification table

Packaging

T: Tape and Reel
(4kpcs / reel)



5101 Hidden Creek Ln Spicewood TX 78669
 Phone: 512-371-6159 | Fax: 512-351-8858
 For terms and conditions of sales, please visit:
www.abracon.com

REVISION: IR 08-10-22

ABRACON IS
 ISO9001-2015
 CERTIFIED

Automotive Ferrite Chip Beads



AFBC-Q0805

Request Samples



Check Inventory



2.00 x 1.25 x 0.85 mm
RoHS/RoHS II Compliant
MSL Level = 1

Mechanical Specifications

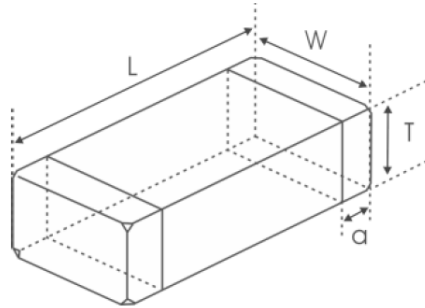

L	W	T	a	H	I	J
2.00±0.20	1.25±0.20	0.85±0.20	0.50±0.30	1.45 Ref.	1.05 Ref.	1.00 Ref.

Dimension: mm

Materials

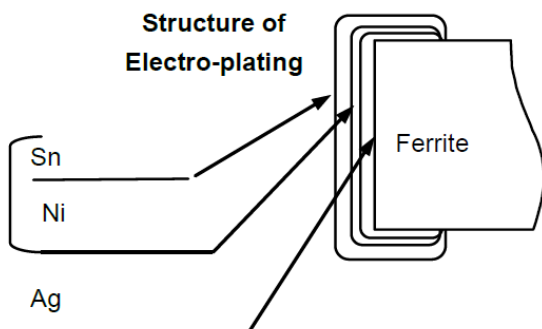

	Structure Description
1	Ferrite for Beads
2	Internal Terminal Electrode: Ag (100%)
3	Electro-plating: Ni (100%)
4	External Electro-plating: Sn (100%)

Automotive Ferrite Chip Beads



AFBC-Q0805

Request Samples



Check Inventory



2.00 x 1.25 x 0.85 mm
 RoHS/RoHS II Compliant
 MSL Level = 1

Reflow Profile

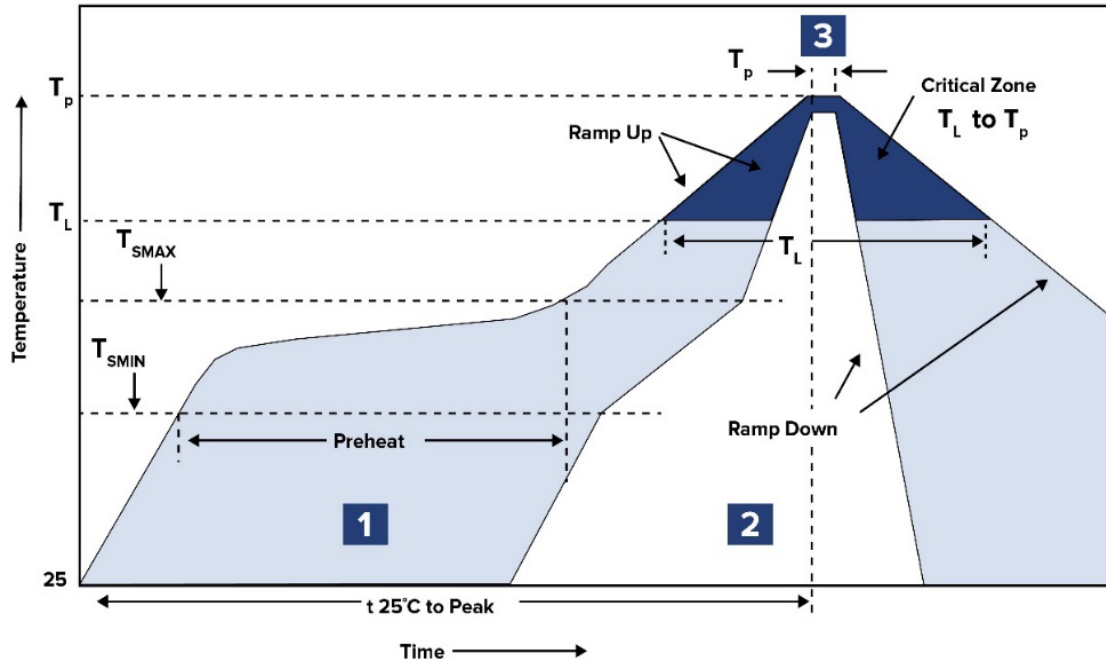

Zone	Description	Temperature	Times
1	Preheat	$T_{SMIN} \sim T_{SMAX}$ 150°C ~ 200°C	60 ~ 180 sec.
2	Reflow	T_L 245°C	20 ~ 40 sec.
3	Peak heat	T_P 260°C	10 sec. MAX

Automotive Ferrite Chip Beads

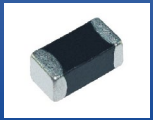

AFBC-Q0805

Request Samples



Check Inventory



2.00 x 1.25 x 0.85 mm
RoHS/RoHS II Compliant
MSL Level = 1

Packaging

T= Tape and reel (4,000 pcs/reel)

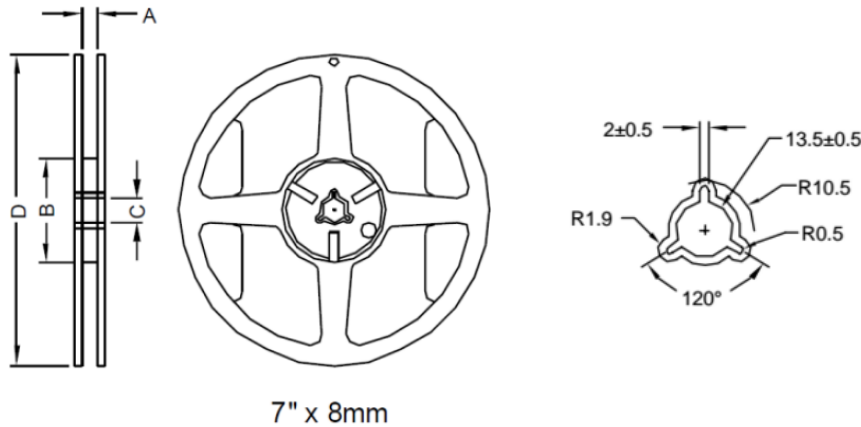

Type	A	B	C	D
7"x8mm	9.0 ± 0.5	60.0 ± 2.0	13.5 ± 0.5	178.0 ± 2.0

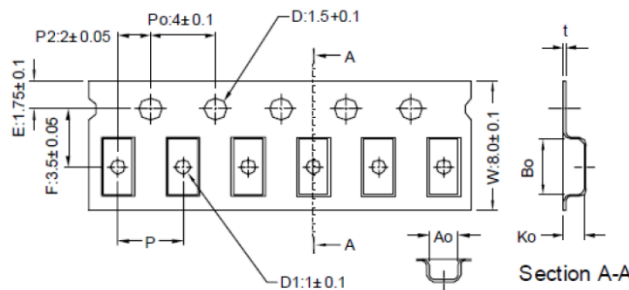

Series	Bo	Ao	Ko	P
AFBC-Q0805	2.10 ± 0.05	1.30 ± 0.05	0.95 ± 0.05	4.00 ± 0.05

Dimension: mm

ATTENTION: Abracon LLC's products are COTS – Commercial-Off-The-Shelf products; suitable for Commercial, Industrial and, where designated, Automotive Applications. Abracon's products are not specifically designed for Military, Aviation, Aerospace, Life-dependent Medical applications or any application requiring high reliability where component failure could result in loss of life and/or property. For applications requiring high reliability and/or presenting an extreme operating environment, written consent and authorization from Abracon LLC is required. Please contact Abracon LLC for more information.



5101 Hidden Creek Ln Spicewood TX 78669
 Phone: 512-371-6159 | Fax: 512-351-8858
 For terms and conditions of sales, please visit:
www.abracon.com

REVISION: IR 08-10-22

ABRACON IS
 ISO9001-2015
 CERTIFIED