

PCB Information	Name: DFR0515[V1.0]	Thickness: 1.6mm
Engineer: HDJ	Top SolderMask: Black	Bottom SolderMask: Black
Date: 20170915	Top Silkscreen: White	Bottom Silkscreen: White

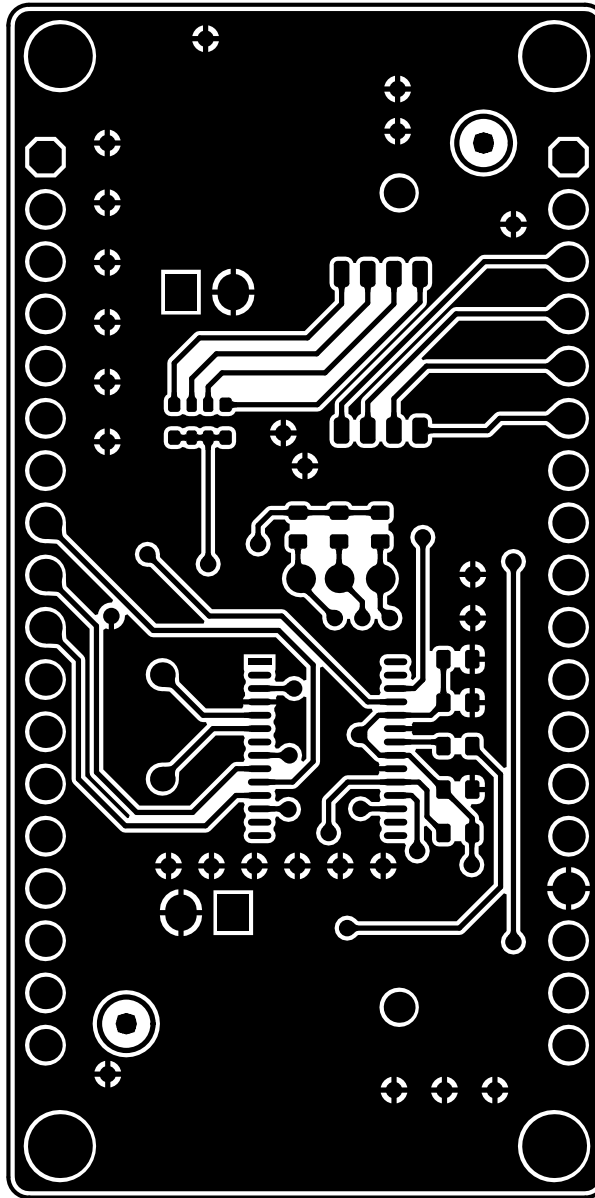

PCB Information	Name: DFR0515[V1.0]	Thickness: 1.6mm
Engineer: HDJ	Top SolderMask: Black	Bottom SolderMask: Black
Date: 20170906	Top Silkscreen: White	Bottom Silkscreen: White

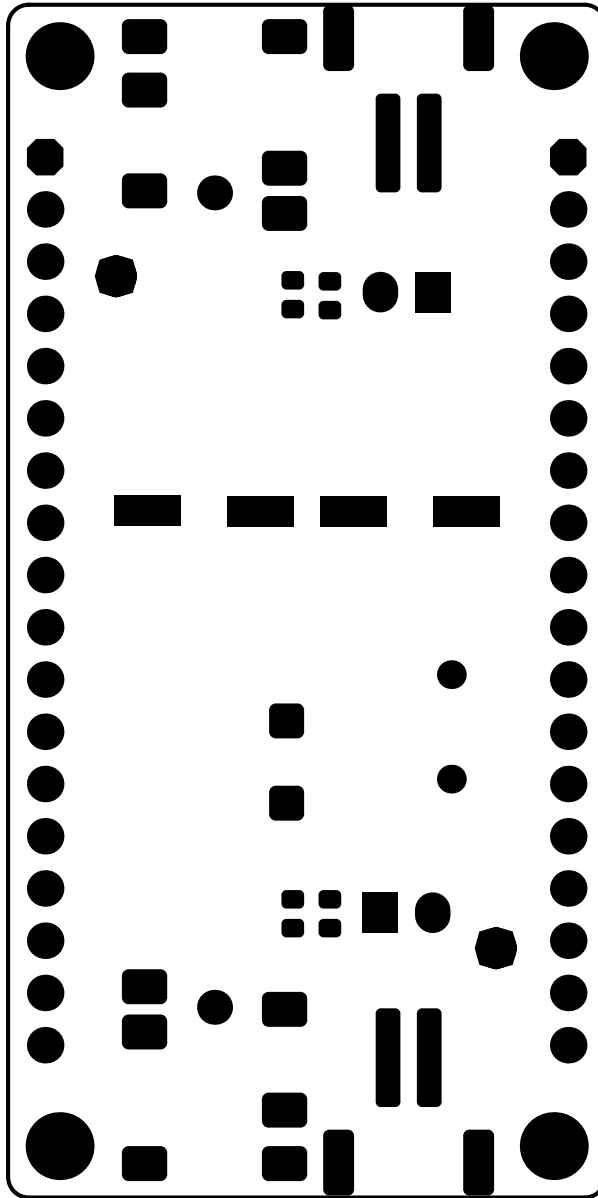

PCB Information	Name: DFR0515[V1.0]	Thickness: 1.6mm
Engineer: HDJ	Top SolderMask: Black	Bottom SolderMask: Black
Date: 20170915	Top Silkscreen: White	Bottom Silkscreen: White

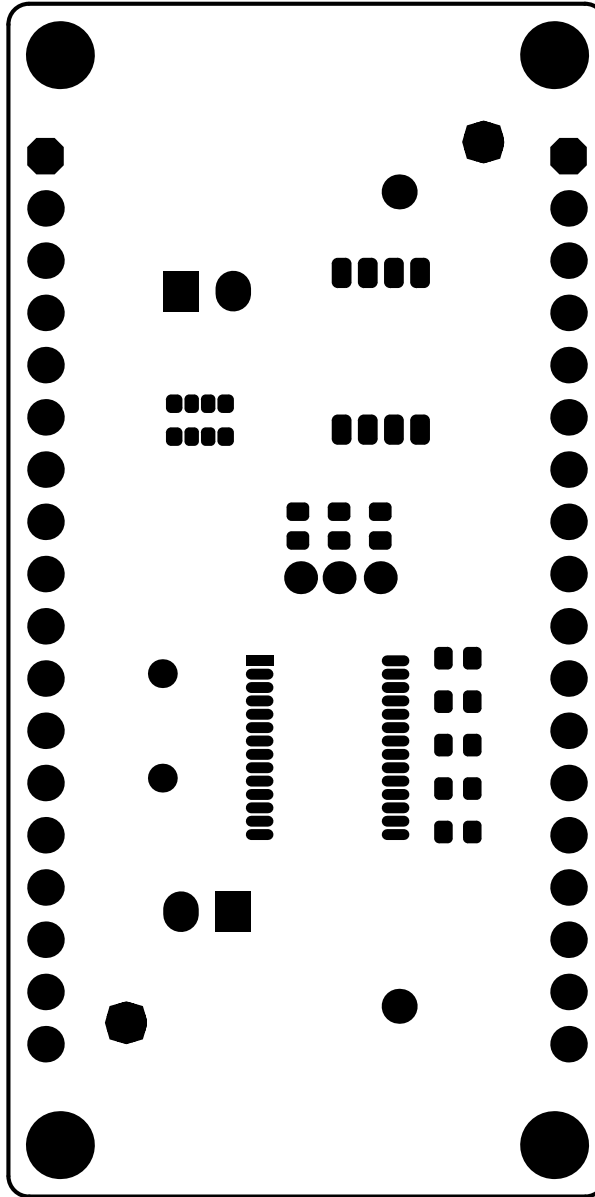

PCB Information	Name: DFR0515[V1.0]	Thickness: 1.6mm
Engineer: HDJ	Top SolderMask: Black	Bottom SolderMask: Black
Date: 20170906	Top Silkscreen: White	Bottom Silkscreen: White

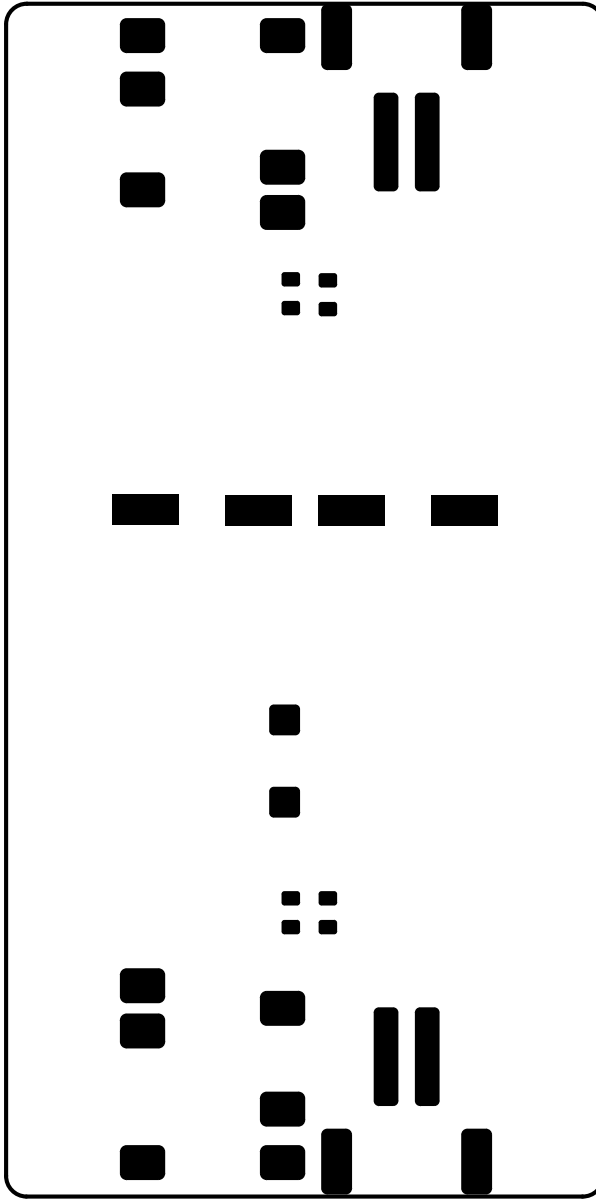

PCB Information	Name: DFR0515[V1.0]	Thickness: 1.6mm
Engineer: HDJ	Top SolderMask: Black	Bottom SolderMask: Black
Date: 20170915	Top Silkscreen: White	Bottom Silkscreen: White

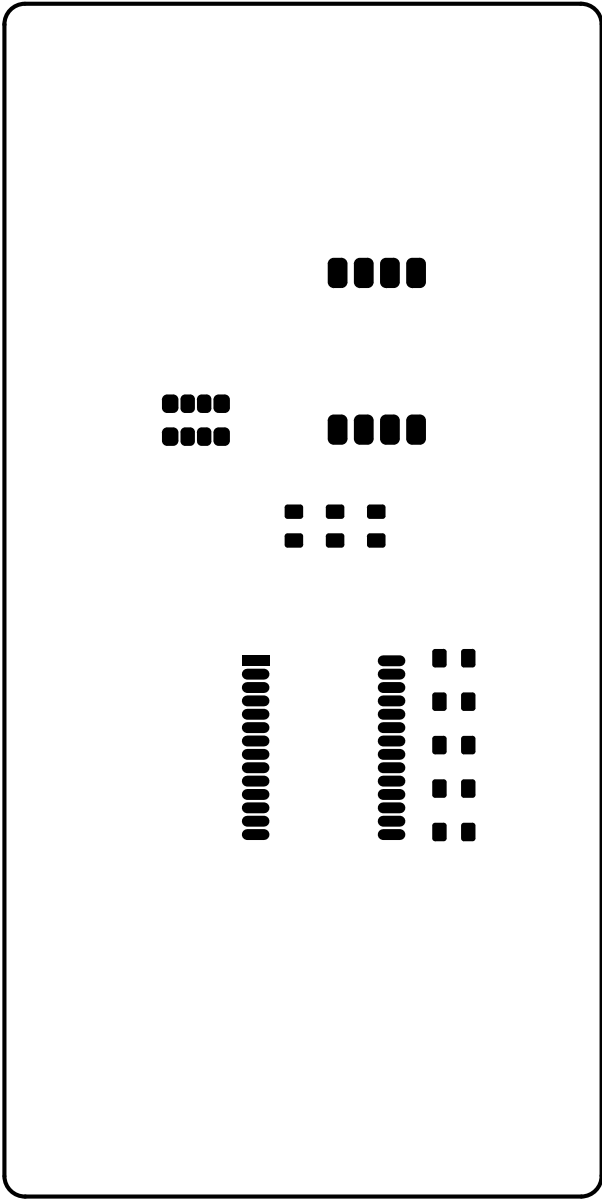

PCB Information	Name: DFR0515[V1.0]	Thickness: 1.6mm
Engineer: HDJ	Top SolderMask: Black	Bottom SolderMask: Black
Date: 20170906	Top Silkscreen: White	Bottom Silkscreen: White

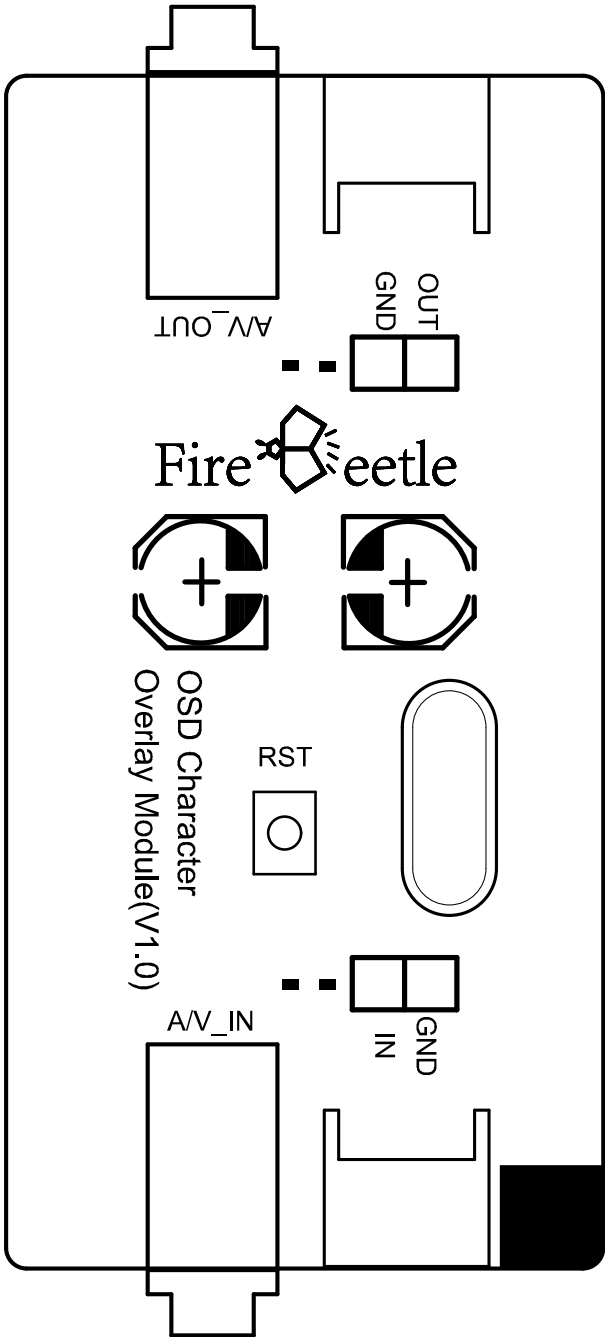

PCB Information	Name: DFRO515(V1.0)	Thickness: 1.6mm
Engineer: HDJ	Top SolderMask: Black	Bottom SolderMask: Black
Date: 20170915	Top Silkscreen: White	Bottom Silkscreen: White

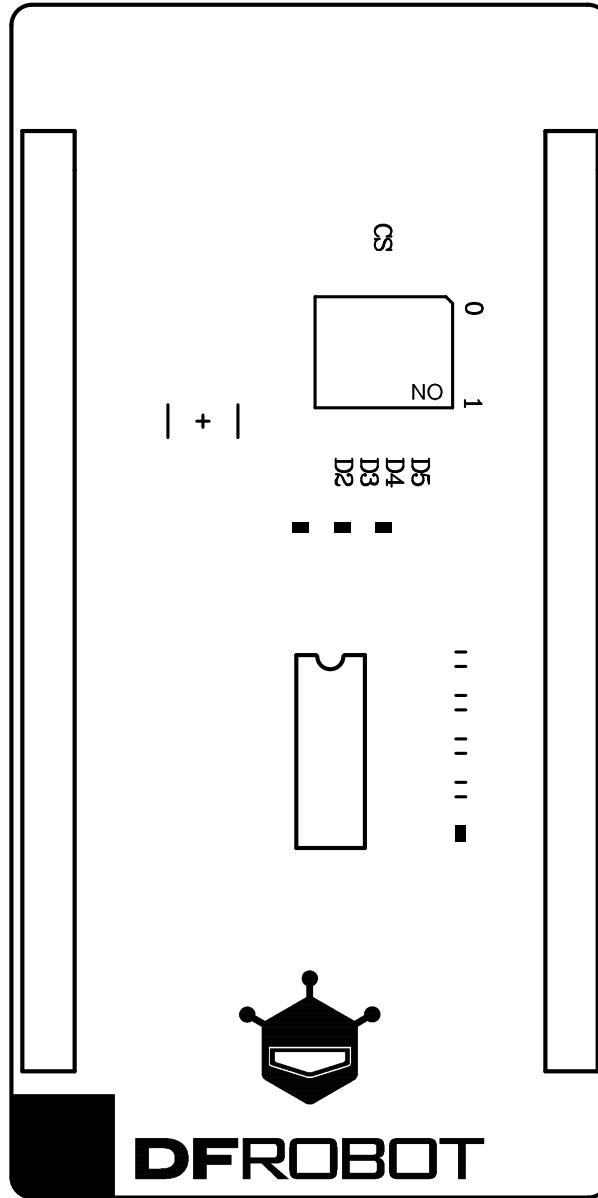

PCB Information	Name: DFR0515[V1.0]	Thickness: 1.6mm
Engineer: HDJ	Top SolderMask: Black	Bottom SolderMask: Black
Date: 20170906	Top Silkscreen: White	Bottom Silkscreen: White

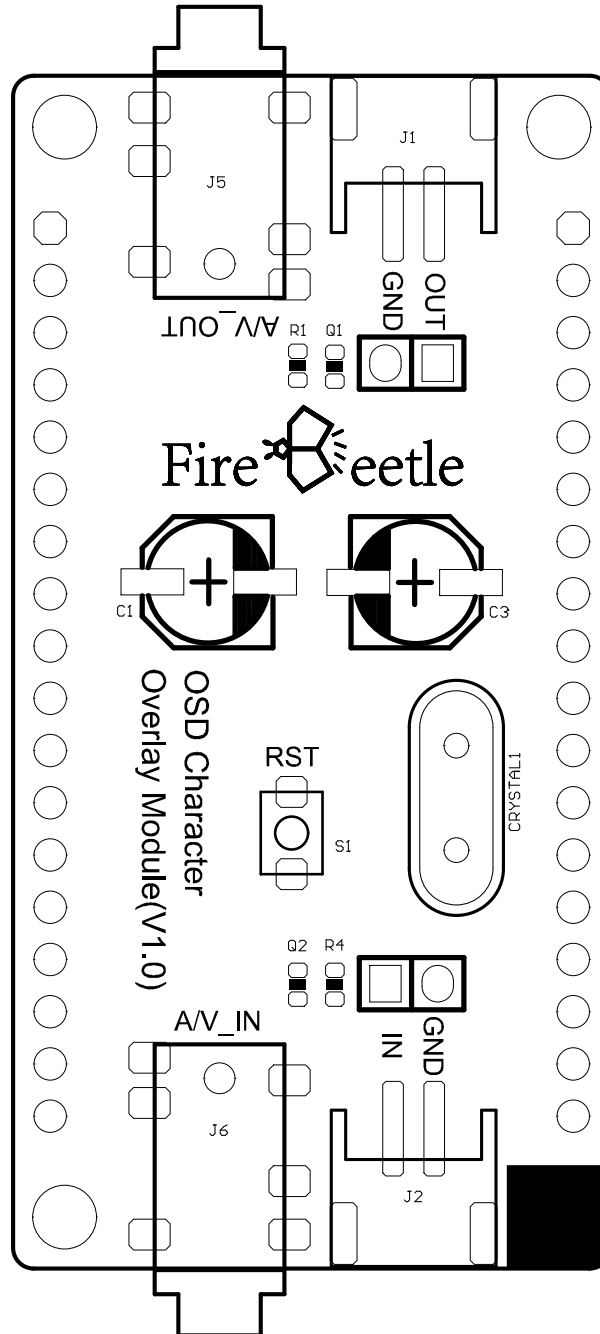

PCB Information	Name: DFRO515(V1.0)	Thickness: 1.6mm
Engineer: HDJ	Top SolderMask: Black	Bottom SolderMask: Black
Date: 20170915	Top Silkscreen: White	Bottom Silkscreen: White

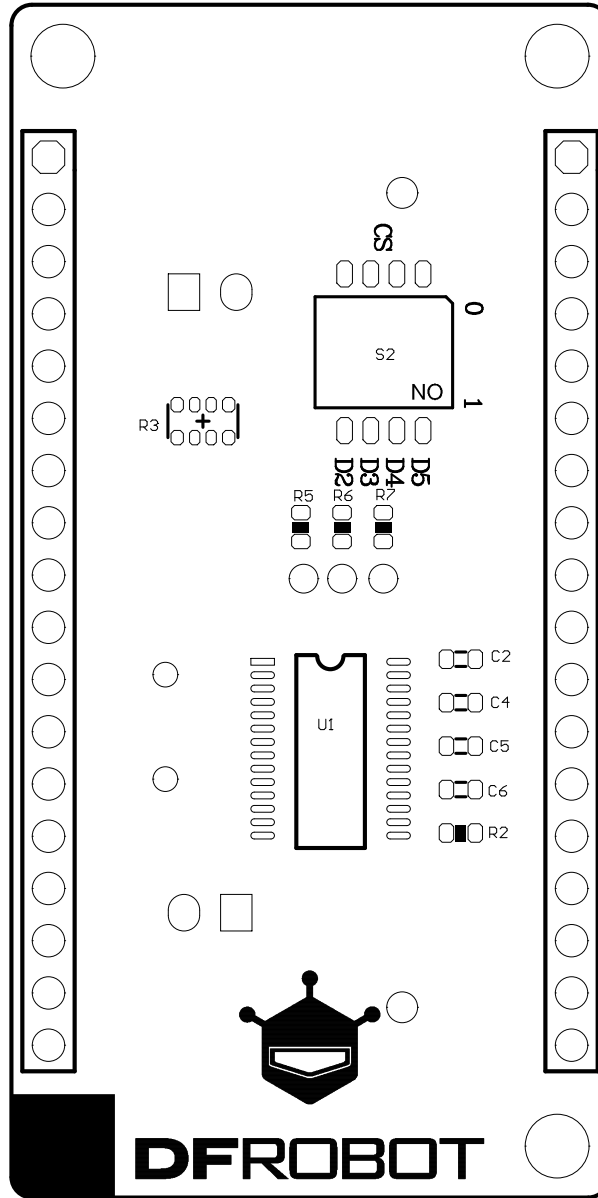

PCB Information	Name: DFR0515[V1.0]	Thickness: 1.6mm
Engineer: HDJ	Top SolderMask: Black	Bottom SolderMask: Black
Date: 20170906	Top Silkscreen: White	Bottom Silkscreen: White

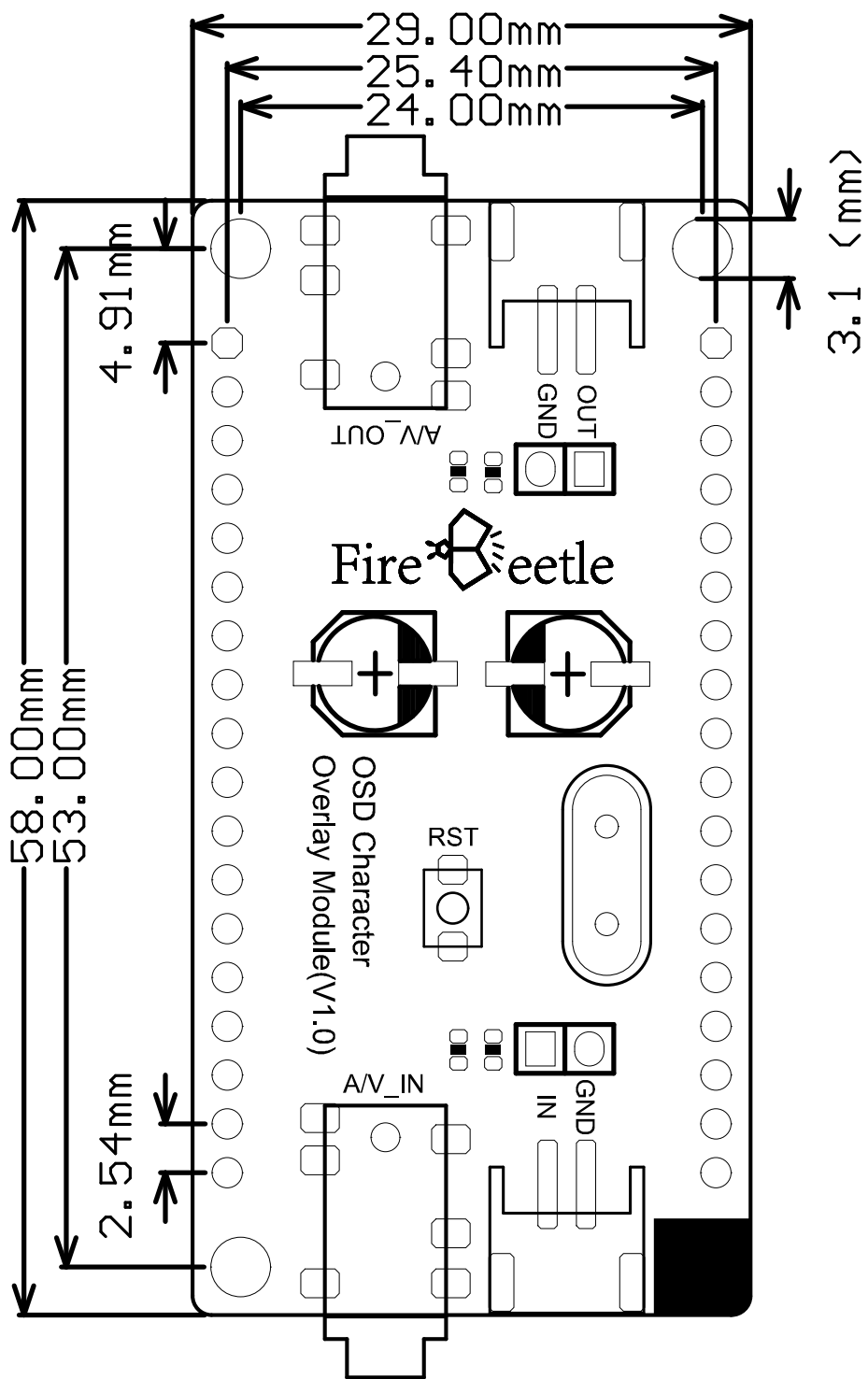

PCB Information	Name: DFRO515(V1.0)	Thickness: 1.6mm
Engineer: HDJ	Top SolderMask: Black	Bottom SolderMask: Black
Date: 20170915	Top Silkscreen: White	Bottom Silkscreen: White

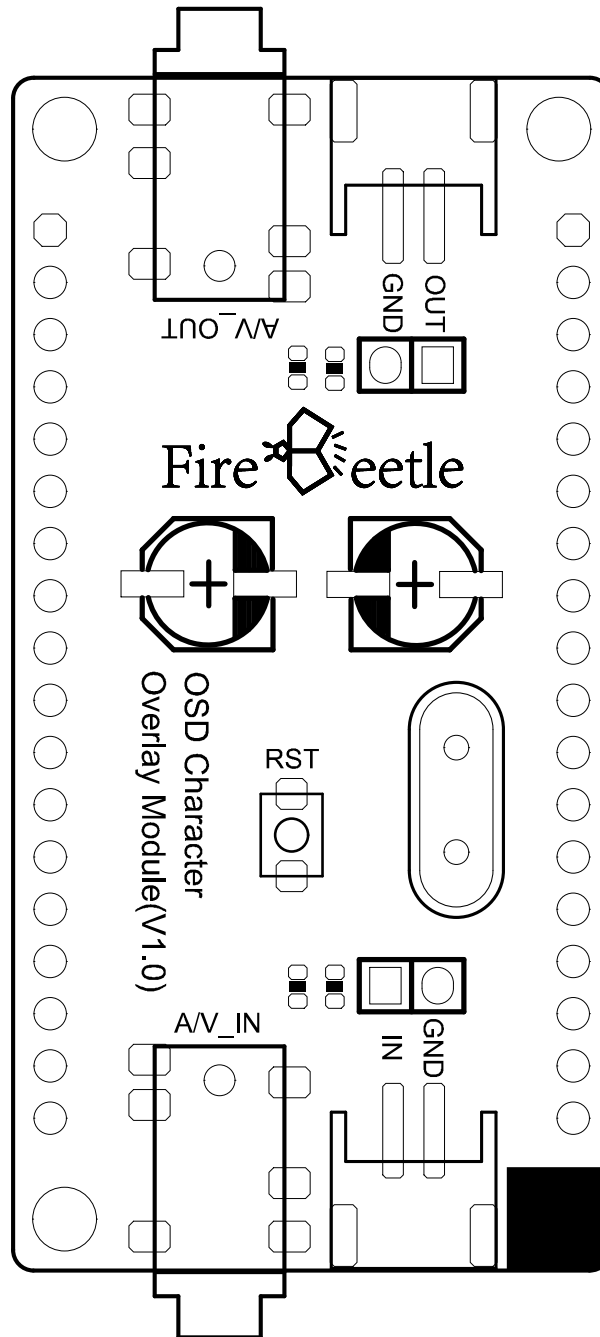

PCB Information	Name: DFRO515[V1.0]	Thickness: 1.6mm
Engineer: HDJ	Top SolderMask: Black	Bottom SolderMask: Black
Date: 20170915	Top Silkscreen: White	Bottom Silkscreen: White

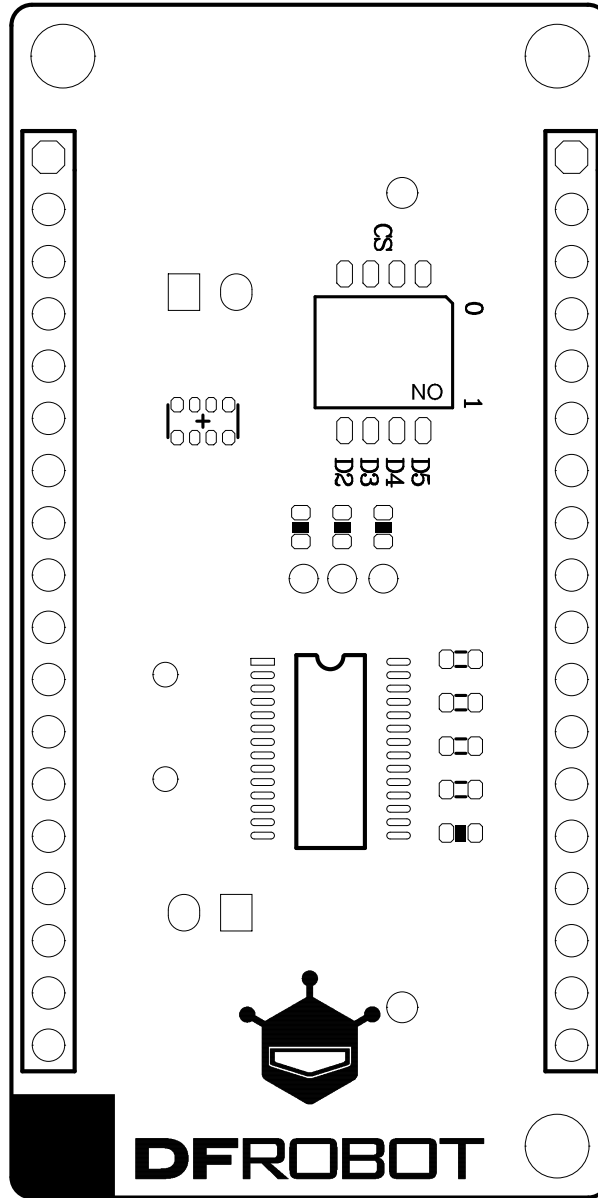

PCB Information	Name: DFR0515[V1.0]	Thickness: 1.6mm
Engineer: HDJ	Top SolderMask: Black	Bottom SolderMask: Black
Date: 20170906	Top Silkscreen: White	Bottom Silkscreen: White