

AMR4100

High accuracy analog output dual axis position sensor

Description

AMR4100 is based on the principle of anisotropic magnetoresistance (AMR), and its output voltage changes with the direction of the magnetic field (target magnetic field) received. The AMR4100 outputs two sets of analog voltage signals (sine and cosine) with a phase difference of 45° when the magnetic field direction rotates one circle. The period of these two sets of analog voltage signals is twice the rotation period of the magnetic field direction. The angular position information of the target magnetic field can be determined in real time by calculating the two sets of analog voltage signals.

Through the optimized design, the temperature drift of the AMR4100 is effectively compensated, the measurement accuracy of the sensor in various application environments is improved, and the limitation for the installation distance between the measured object and the sensor is reduced. It is available in the compact DFN12L(6 mm × 2 mm × 0.75 mm) packages and easy to assemble in tight spaces.

Features and benefits

- Anisotropic magnetoresistance (AMR) technology
- Wide operating voltage range (up to ±9 V)
- Sine/cosine signal output (differential analog signal)
- Excellent thermal stability
- High accuracy (absolute accuracy 0.1°)
- RoHS & REACH compliant

Applications

- Linear displacement sensing
- Length measurement
- Linear encoder
- High speed rotation encoder
- Angular displacement sensing
- Knob sensor

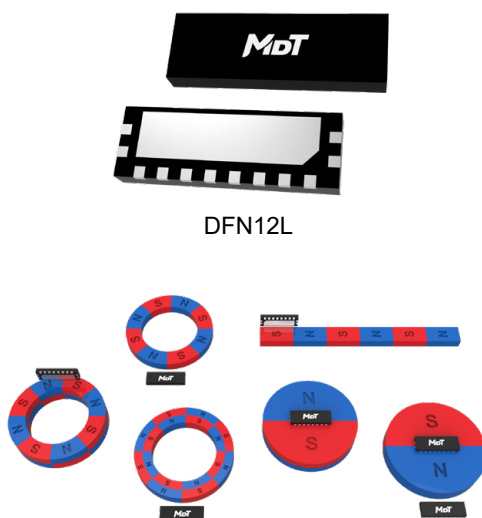

Application schematics of AMR4100

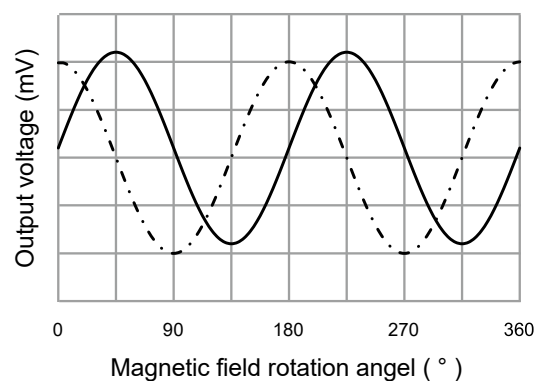

Selection Guide

Part Number	Bridge resistance	Output amplitude	Output period	Package	Packing Form
AMR4100	2.7 K Ω	13 mV/V	180°	DFN12L	Tape & Reel

Catalogue

1. Functional Block Diagram.....	03
2. Application schematics	03
3. Pin Configuration	03
4. Absolute Maximum Ratings	04
5. Electrical Specifications.....	04
6. Magnetic Specifications.....	04
7. Application Information	05
8. Dimensions.....	06

1. Functional Block Diagram

Eight AMR resistors inside the sensor, power supply and electrical connection of two sets of analog voltage outputs as shown in Figure 1.

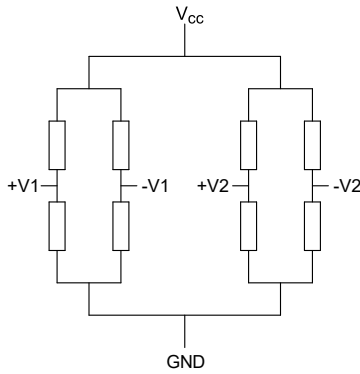

Figure 1. Block diagram

2. Application schematics

AMR4100 sensor responds to horizontal magnetic field (X-Y plane), and magnetic field rotation angle θ was defined as 0° , while $V1 = V_{PEAK}$ and $V2 = V_{OFF}$, when magnetic field direction is in the same direction as X-axis as shown in Figure 3, the red dash line.

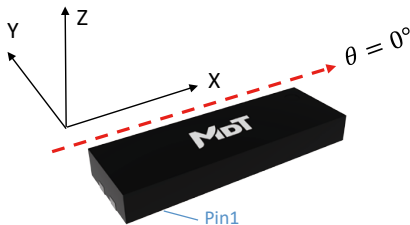

Figure 2. Sensing direction

The positions and magnetization directions of eight AMR sensing elements integrated in the sensor are precisely designed, so that the sensor output $V1 = A\cos(2\theta)$ represents the angle between the direction of the external magnetic field and X axis, and $V2 = B\sin(2\theta)$ represents the angle between the direction of the external magnetic field and Y axis, where A and B are constant and $A \cong B$. The angular position information of the applied magnetic field at any time can be obtained by combining the V1 and V2 signals at the corresponding time.

Each output signal is a differential analog voltage signal, and each signal consists of two pin outputs as shown in the table of pin configuration section.

3. Pin Configuration

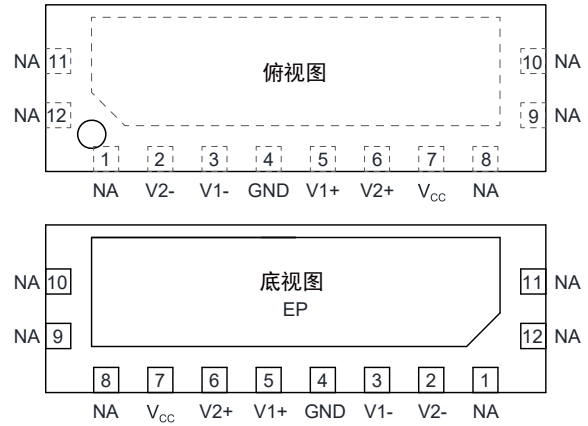

Figure 3. Pin configuration (DFN12L)

Number	Symbol	Function
1	NA	-
2	V2-	Sin signal negative output
3	V1-	Cos signal negative output
4	GND	Ground
5	V1+	Cos signal positive output
6	V2+	Sin signal positive output
7	V _{CC}	Power supply
8	NA	-
9	NA	-
10	NA	-
11	NA	-
12	NA	-
-	EP	Heat dissipation pad

Note: Pin 9, pin 12 and heat dissipation pad EP are internally connected

4. Absolute Maximum Ratings

Parameters	Symbol	Min.	Max.	Unit
Supply voltage	V_{CC}	-9	9	V
Operating ambient temperature	T_A	-40	125	°C
Storage ambient temperature	T_{STG}	-40	150	°C

5. Electrical Specifications

$V_{CC} = 5\text{ V}$, $T_A = 25\text{ °C}$, a 0.1 μF capacitor is connected between V_{CC} and GND

Parameter	Symbol	Condition	Min.	Typ.	Max.	Unit
Supply voltage	V_{CC}	-	-	5	-	V
Angle error	$\Delta\theta$	-	-	0.1	-	°
Response time ¹⁾	t_{response}	-	0.1	-	1	μs
Offset ²⁾	V_{OFFSET}	-	-2.0	-	+2.0	mV/V
Offset temperature coefficient ³⁾	TCO	$T_1 = -40\text{ °C}$, $T_2 = +150\text{ °C}$	-2.0	-	+2.0	$\mu\text{V/V/°C}$
Output amplitude ⁴⁾	V_{PEAK}	-	11.0	13.0	15.0	mV/V
V_{PEAK} temperature coefficient ⁵⁾	TCV_{PEAK}	$T_1 = -40\text{ °C}$, $T_2 = +150\text{ °C}$	-0.32	-0.36	-0.40	%/°C
Bridge resistance ⁶⁾	R_B	-	2.2	2.7	3.2	k Ω
Resistance temperature coefficient ⁷⁾	TCR_B	$T_1 = -40\text{ °C}$, $T_2 = +150\text{ °C}$	0.34	0.38	0.42	%/°C

6. Magnetic Specifications

Parameter	Symbol	Condition	Min.	Typ.	Max.	Unit
Applied magnetic field	B	-	-	300	-	Gs
Applied magnetic field	B	Anti-interference enhanced	-	750	-	Gs

Note:

1) Response time is defined as the delay of the output signal relative to the change in the magnetic field

$$2) V_{\text{OFFSET}} = \frac{V_{\text{MAX}} + V_{\text{MIN}}}{2}$$

$$3) \text{TCO} = \frac{V_{\text{OFF}}(T_2) - V_{\text{OFF}}(T_1)}{T_2 - T_1}$$

$$4) V_{\text{PEAK}} = \frac{V_{\text{MAX}} - V_{\text{MIN}}}{2}$$

$$5) \text{TCV}_{\text{PEAK}} = \frac{V_{\text{PEAK}}(T_2) - V_{\text{PEAK}}(T_1)}{V_{\text{PEAK}}(T_1) \times (T_2 - T_1)} \times 100\%$$

6) Resistance between V1+ and V1- and/or between V2+ and V2-

$$7) \text{TCR}_B = \frac{R_B(T_2) - R_B(T_1)}{R_B(T_1) \times (T_2 - T_1)} \times 100\%$$

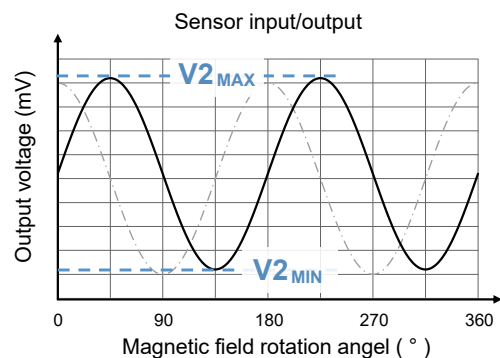

7. Application Information

The AMR elements in chip work in the saturation status, when the applied magnetic field strength B is 300 Gs (25000 A/m) or above, and the output signal will not change with the applied magnetic field strength in this case. This allows the AMR4100 to better adapt to a variety of applications environment, such as air-gap vibration or high temperature demagnetization during the operation of the measurement system.

The output signal amplitude of AMR4100 is proportional to the power supply voltage. Figure 4 and 5 are the schematic diagrams of the waveforms of the two output signals of the sensor in 2 cycles when power supply is 5 V.

The signal processing algorithm for sampling, correcting, and decoding the output SIN/COS analog signals will directly affect the final measurement accuracy.

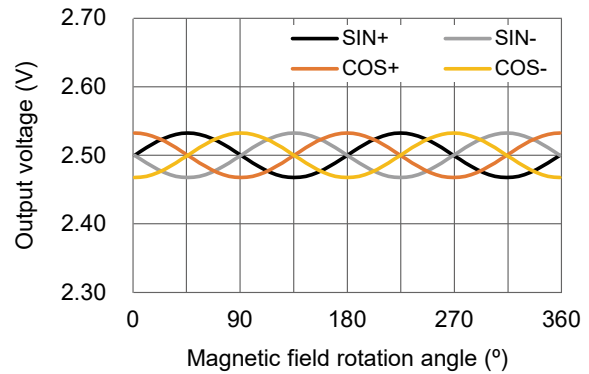

Figure 4. Schematic diagram of the single-ended output voltage waveform of AMR4100 within 2 cycles

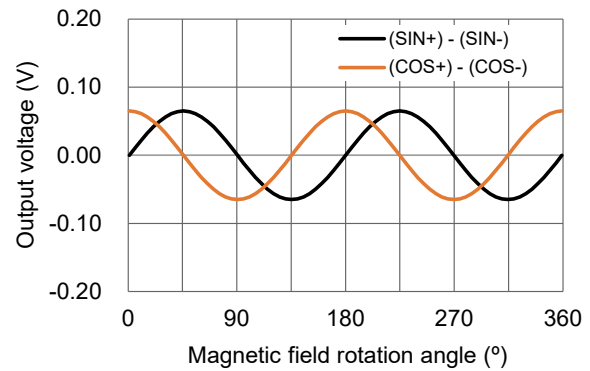

Figure 5. Schematic diagram of the differential output voltage waveform of AMR4100 within 2 cycles

8. Dimensions

DFN12L Package

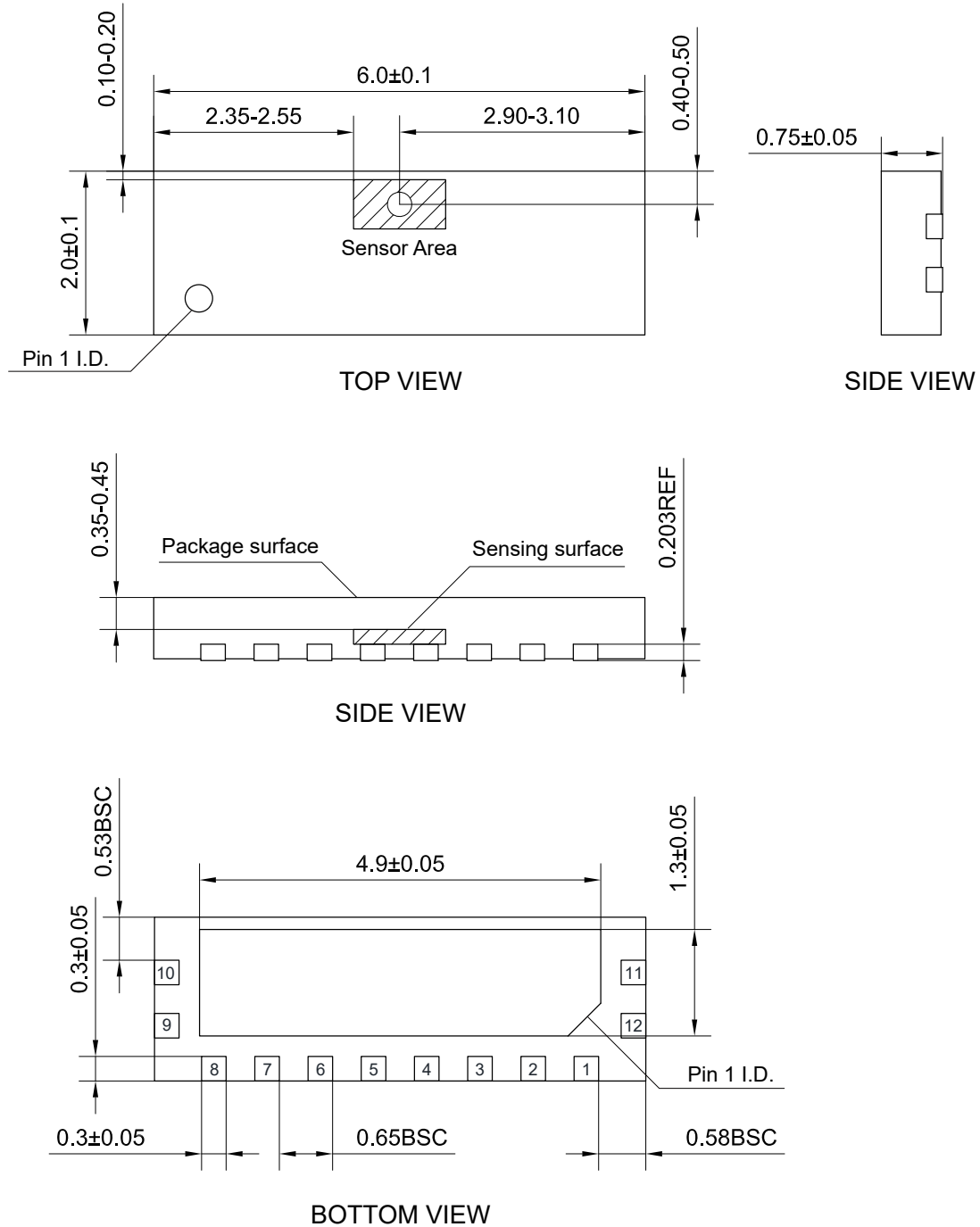

Figure 6. Package outline of DFN12L (unit: mm)

Copyright © 2022 by MultiDimension Technology Co., Ltd.

Information furnished herein by MultiDimension Technology Co., Ltd. (hereinafter MDT) is believed to be accurate and reliable. However, MDT disclaims any and all warranties and liabilities of any kind, with respect to any examples, hints or any performance or use of technical data as described herein and/or any information regarding the application of the product, including without limitation warranties of non-infringement of intellectual property rights of any third party. This document neither conveys nor implies any license under patent or other industrial or intellectual property rights. Customer or any third-party must further determine the suitability of the MDT products for its applications to avoid the applications default of customer or third-party. MDT accept no liability in this respect.

MDT does not assume any liabilities of any indirect, incidental, punitive, special or consequential damages (including without limitation of lost profits, lost savings, business interruption, costs related to the removal or replacement of any products or rework charges) whether or not such damages are based on tort (including negligence), warranty, breach of contract or any other legal theory. Notwithstanding any damages that customer might incur for any reason whatsoever, MDT's aggregate and cumulative liability towards customer for the products described herein shall be limited in accordance with the terms and conditions of commercial sale of MDT.

Absolute maximum ratings are the extreme limits the device will withstand without damage to the MDT product. However, the electrical and mechanical characteristics are not guaranteed as the maximum limits (above recommended operating conditions) are approached. MDT disclaims any and all warranties and liabilities of the MDT product will operate at absolute maximum ratings.

Specifications may change without notice.

Please download latest document from our official website www.dowaytech.com/en.

Recycling

The product(s) in this document need to be handed over to a qualified solid waste management services company for recycling in accordance with relevant regulations on waste classification after the end of the product(s) life.



No.2 Guangdong Road, Zhangjiagang Free Trade Zone, Jiangsu, China

Web: www.dowaytech.com/en E-mail: info@dowaytech.com

