

CLP0205 Open Frame Power Supply

90 - 265Vac input; 5Vdc output; 200W Output Power

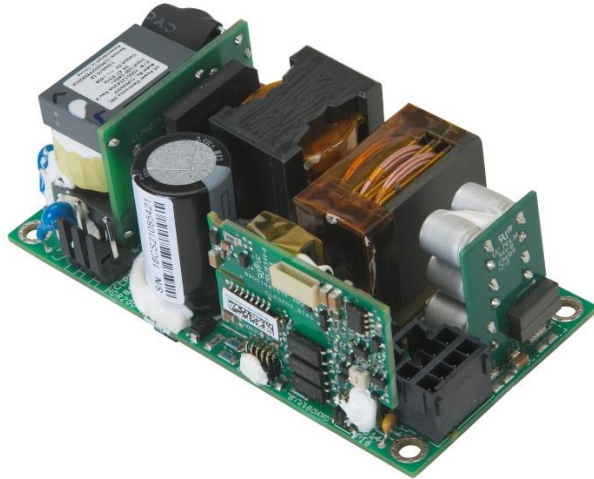

Applications

- Industrial equipment
- LED Signage
- Telecommunications equipment

Description

In a small 2 x 4 inch footprint, the 5Vdc single-output CLP0205 open frame power supply delivers greater than 90 percent typical power efficiency and full load output at 50°C and 1m/s airflow. Protection features include output overcurrent (OCP), overvoltage (OVP), and overtemperature (OTP). This power supply supports active current sharing with a similar unit. Leads and covers are available as accessories.

Features

- Compact size 50.8mm x 101.6mm x 36.1mm (2in x 4in x 1.4in) with density of 18W/in³
- Universal AC Input Range (90 – 265VAC)
- Output voltage of 5V (adjustable 4.5V to 5.2V)
- Active current sharing
- Standby output of 12V @ 0.1A
- Maximum output current of 40A@ 5Vout (200W)
- High efficiency
- Full load capability at 50°C and 1m/s airflow with derating at higher temperatures or lower airflows
- Capable of 135 W out in sealed enclosure applications with enclosure ambient at 55°C
- Output overcurrent protection (non-latching)
- Overtemperature protection
- Output overvoltage protection
- Minimum of 11ms of holdup time at 200W out
- Active power factor corrected input
- Conducted EMI - meets CISPR32 (EN55032) and FCC Class B requirements
- Compliant to RoHS (recast) EU Directive 2011/65/EC and amended Directive (EU) 2015/863
- Compliant to REACH Directive (EC) No 1907/2006
- UL and cUL approved to UL/CSA62368-1, TUV (EN62368-1), CE Mark (for LVD) and CB Report available
- ISO** 9001 and ISO 14001 certified manufacturing facilities

* UL is a registered trademark of Underwriters Laboratories, Inc.

† CSA is a registered trademark of Canadian Standards Association.

** ISO is a registered trademark of the International Organization of Standards

CLP0205 Open Frame Power Supply

90 - 265Vac input; 5Vdc output; 200W Output Power

Absolute Maximum Ratings

Stresses over the absolute maximum ratings can cause permanent damage to the device. Functional operation of the device is not implied at these or any other conditions over those given in the operations sections of the data sheet. Exposure to absolute maximum ratings for extended periods can adversely affect the device reliability.

Parameter	Device	Min	Max	Unit
Input Voltage - Continuous	All	90	265	Vac
For up to 10 seconds	All	90	275	Vac
Operating Ambient Temperature (see Thermal Considerations section)	All	-40	70	°C
Storage Temperature	All	-40	85	°C
Humidity (non-condensing)	All	5	95	%
Altitude	All		5000	m
Isolation Voltage – Input to output	All		3000	Vac
Input to safety ground	All		1500	Vac
Outputs to safety ground	All		50	Vac

Electrical Specifications

Parameter	Device	Min	Typ	Max	Unit
Operating Input Voltage	All	90	115/230	265	Vac
Input Source Frequency	All	47	50/60	63	Hz
Input Current ($V_{IN} = 90\text{Vac}$)	All			2.7	A _{RMS}
Input Power Factor (230Vac, Full Load)	All	0.95			
Inrush Transient Current ($V_{IN} = 265\text{Vac}$, $T_{amb} = 25^\circ\text{C}$)	All			100	A Peak
Leakage Current to earth ground ($V_{IN} = 265\text{Vac}$)	All			3.5	mA
Output Voltage Setpoint	All		5		Vdc
Output Voltage Tolerance (due to set point, temperature variations, load and line regulation)	All	-2		2	%
Output Voltage Adjustment Range	All	4.5		5.2	Vdc
Output Remote Sense Range	All			250	mVdc
Output Load Regulation	All			1	%Vout
Output Line Regulation	All			0.25	%Vout
Output Ripple and Noise – measured with 0.1µF ceramic capacitor in parallel with 10µF electrolytic capacitor Peak-to-peak (20MHz Bandwidth)	All			100	mV p-p
Dynamic Load Response – 50% to 100% load transient, 1A/µs slew rate Output voltage deviation Settling Time	All All			250 500	mV µs
Output Current	All	0		40	A _{dc}
Output Current Limit Inception	All	105		145	% $I_{O,max}$
Maximum Output Capacitance	All			5000	µF
Standby Output Voltage (regulation is +/-2%)	All		12.0		Vdc
Standby Output Current	All			0.1	A _{dc}
Efficiency: $V_{IN} = 230\text{Vac}$, 20% load	All		85		%
50% load	All		90		%
100% load	All		91.5		%
$V_{IN} = 115\text{Vac}$, 20% load	All		87		%
50% load	All		90.5		%
100% load	All		90		%
Holdup Time ¹ – $V_{IN} = 115\text{Vac}$, 200W load	All	11			ms
$V_{IN} = 230\text{Vac}$, 200W load	All	11			ms

¹ Holdup time may be lower at temperatures below -25C

CLP0205 Open Frame Power Supply

90 - 265Vac input; 5Vdc output; 200W Output Power

General Specifications

Parameter	Device	Symbol	Typ.	Unit
Calculated Reliability based on Telcordia SR-332 Issue 2: Method 1 Case 3 ($V_{IN}=230Vac$, $I_o = 35A$, $T_A = 40^{\circ}C$, R:\ACDC\LPSP design team\Change record of family code\CLPs\CLP0205 200LFM, 90% confidence)	All	MTBF	>750,000	Hours
Weight	All		400 14.1	g oz.

Feature Specifications

Parameter	Device	Min	Typ	Max	Unit
On/Off Signal Interface – signal referenced to GND					
Logic Low (Power Supply ON)					
Input Low Current	All			7	mA
Input Low Voltage	All			1	V
Logic High (Power Supply OFF)					
Input High Current	All			600	μA
Input Voltage	All			5.5	V
Delay from ON/OFF being enabled to start of output voltage rise	All			50	ms
Output Voltage Rise Time (from 10 to 90% of final value)	All		20		ms
Delay from Input being applied to all outputs being in regulation	All			800	ms
Output Overvoltage Protection	All	5.75		6.6	Vdc
Input Under-voltage lockout ²					
Turn-on Threshold (100% load)	All	75	81	90	Vac
Turn-off Threshold (100% load)	All	65	72	88	Vac
DC OK – open collector, High when output available					
Sink Current	All			4	mA
Maximum Collector Voltage	All			12	V
Output Current Sharing ³					
Number of identical units able to current share	All			2	
Output voltage set-point difference for current sharing	All	-50	0	+50	mV
Output current difference between sharing units	All	-6	0	+6	%
Reverse current between sharing units	All	0	0.1	1	A

² Under-voltage lockout threshold may vary with output load current level – decreasing as load goes lower

³ Output current sharing is controlled by an analogue signal referenced to V_{out-} . Best current sharing performance is achieved when the two output voltages are set very close to each other. Although the number of sharing units is limited to 2 in this document, more than two units may well share current adequately, but that is beyond the design intent, and beyond the development test plan. The units do not contain any output OR-ing device. If fault tolerance or redundancy is required, the customer will have to add external output OR-ing devices.

CLP0205 Open Frame Power Supply

90 - 265Vac input; 5Vdc output; 200W Output Power

Environmental Specifications

Parameter	Device	Specification/Test
Conducted Emissions	All	CISPR32 (EN55032) Class B with 3dB margin
Radiated Emissions	All	CISPR32 (EN55032) to comply with system enclosure
ESD	All	IEC61000-4-2, Level 3
Radiated Susceptibility ⁴	All	IEC61000-4-3, Level 3
Electrical Fast Transient Common Mode	All	IEC61000-4-4, Level 3
Surge Immunity	All	IEC61000-4-5, Level 4 & ANSI C62.41 (6kV)
Conducted RF Immunity	All	IEC61000-4-6, Level 3
Input Voltage Dips	All	Output stays within regulation for either ½ cycle interruption or 25% dip from nominal line for 1 second
Input Harmonics	All	IEC61000-3-2
Shock and Vibration	All	IPC-9592B

Safety Specifications

Parameter	Device	Specification
Dielectric Withstand Voltage (between input and output)	All	Minimum of 4,250Vdc for 1 minute
Insulation Resistance (between input and output)	All	Minimum of 5 MΩ
Safety Standards	All	Class 1, IEC62368, EN62368, with the following deviations: UL 62368 (Recognized Component), cUL (Canadian Approval by UL)

⁴ Shall meet when tested in a suitable enclosure

CLP0205 Open Frame Power Supply

90 - 265Vac input; 5Vdc output; 200W Output Power

Safety Considerations

The CLP0205 power supply is intended for inclusion in other equipment and the installer must ensure that it is in compliance with all the requirements of the end application. This product is only for inclusion by professional installers within other equipment and must not be operated as a stand-alone product. The power supply meets Class 1, IEC62368-1, EN62368-1, with the applicable national deviations which approved by TUV and UL (Recognized Component) C-UL (Canadian Approval by UL).

Feature Descriptions

Standby Power Supply

A standby output of 12V in the CLP0205 power supply, comes on when AC input in the operating range is applied.

Remote On/Off

The power supply main output will be on with AC in applied.

Output Voltage Adjustment

The output voltage is capable of being adjusted between 4.5V and 5.2V using a potentiometer on the power supply.

Remote Sense

The power supply has both positive and negative remote sense connections that can be connected to the positive and negative rails of the main output near the load. The power supply operates without the remote sense connections being made.

Overcurrent Protection

To provide protection in a fault condition (output overload), the power supply is equipped with internal current-limiting circuitry and can endure current limiting continuously. At the point of current-limit inception, the unit enters hiccup mode. The power supply operates normally once the output current is brought back into its specified range.

Overvoltage Protection

Overvoltage protection is a feature of the power supply that protects both the load and the power supply from an output overvoltage condition. When an overvoltage occurs, the power supply shuts down and latches off until the overvoltage condition is removed. It is necessary to recycle the input to restart the power supply when this protection is activated.

Overtemperature Protection

The power supply features over temperature protection (shut down). It will restart up after cooling down. The OTP circuit typically operates when the unit is operated at 200W output with an ambient temperature of 60°C and a ducted 1m/s (200LFM) of airflow.

Input Under-voltage Lockout

The power supply begins to operate when input voltage is above turn-on threshold and turn off when input was under the turn-off threshold.

DC OK

The power supply provides a DC OK signal that indicates when the main output is operating normally. This is an open-collector signal that goes high when the output is within regulation.

Power Good LED

A green LED on board the power supply illuminates when the main output voltage is at or above 4.2V.

Paralleling with Active Output Current Sharing

The CLP0205 is capable of being employed in a paralleling scheme, following are some design attributes that need to be carefully considered prior to attempting a parallel operation with multiple CLP0205's. With the following design criteria, the CLP0205 loads share at an accuracy of +/-5%, when the total current draw is at levels above 20% of max overall loading.

- Current share signals of each power supply are connected.
- An external Oring function is employed at the Vout(+) signal. An oring diode or a Mosfet & controller scheme can be used.
- The 5V Standby Return SHOULD NEVER be connected with the VOUT-(RETURN). 5V standby returns need to be connected together, the 5V standby Vout(+) leg remain separate. The 5V standby output is not designed to be paralleled, if there is a desire for these to be paralleled for load sharing, then other considerations need to be included as well. Contact your local ABB sales rep for FAE involvement.
- In the parallel scheme the remote sense function needs to be unused and remote sense signals left floating.

Assembling

Metal screw should be used to mount the unit and 4 mounting holes are connected to Earth well.

CLP0205 Open Frame Power Supply

90 - 265Vac input; 5Vdc output; 200W Output Power

Thermal Considerations

The power supply can be operated in a variety of thermal environments and sufficient cooling. Ambient temperature, airflow speed and direction, power supply dissipation will affect the power derating. A reduction in the operating temperature of the power supply results in increased reliability. The power supply can be capable of delivering full output power of 200W at an ambient temperature of at least 50 °C and 1m/s (200LFM) of ducted airflow when tested in accordance with ABB Engineering department standard practices.

The output power is derated at higher ambient temperatures and lower airflow but it can at least deliver 100W at 70°C and 1m/s (200LFM) of airflow in accordance with ABB standard practice.

In addition, in conduction-cooled applications with a suitable enclosure, the power supply is capable of delivering 135 W when the enclosure ambient temperature is 55°C, with operation at 90VAC in. It can power up in below condition: ≤40% load in -40C to -15C ambient temperature range; > -15C ambient temperature, ≥115Vac and full load.

Thermal Derating

View of how airflow is ducted (to make laminar not turbulent). The direction of the airflow is shown by the arrow.

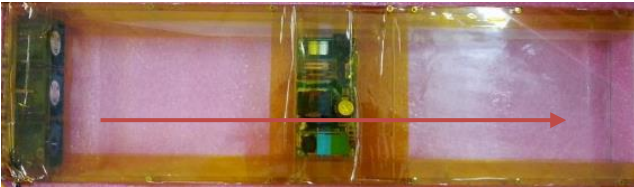

Available output current when the input voltage is 90Vac.

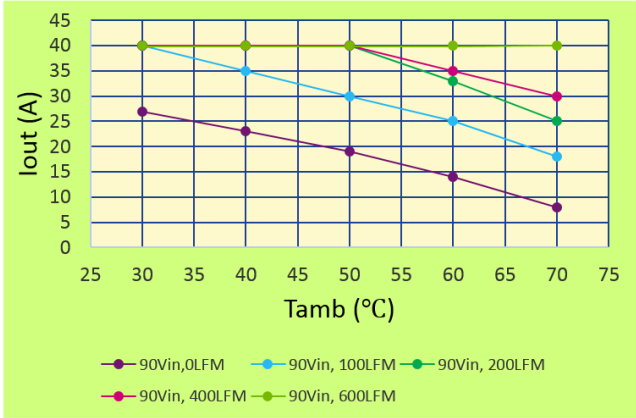

Available output current when the input voltage is 265Vac.

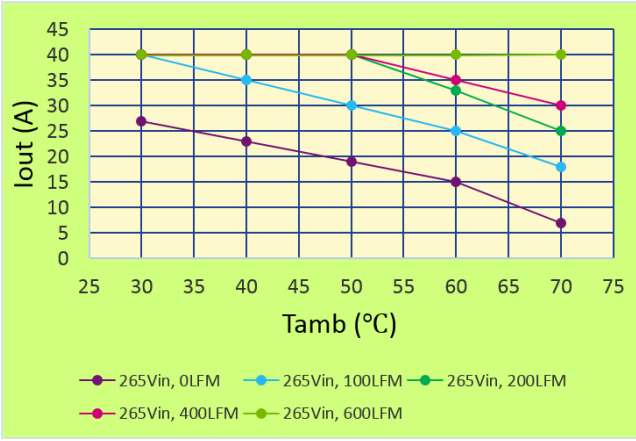

The CLP0205 is able to be used in a sealed enclosure, which also includes the load dissipation. As there are many different variables to be taken into account, each customer has to carry out their own thermal tests. As a general guide, ABB presents the derating curve for using CLP0205 in our sealed enclosure with ABB standard practice.

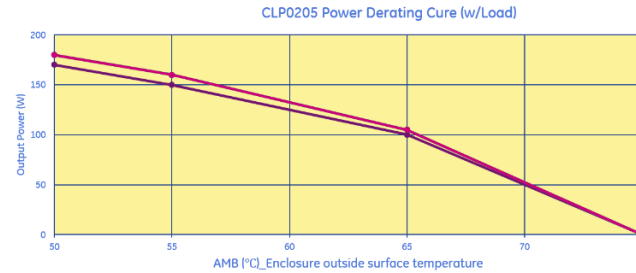

Current Sharing

CLP0205 can support current sharing of 2 identical units with similar cooling. The current sharing signal is referenced to Vout- and the Vout- lines have to be short together with low impedance and noise. The customer need to add external output OR-ing devices for current sharing and redundancy.

CLP0205 Open Frame Power Supply
 90 - 265Vac input; 5Vdc output; 200W Output Power

Mechanical Outline (preliminary and subject to change)

TOP VIEW

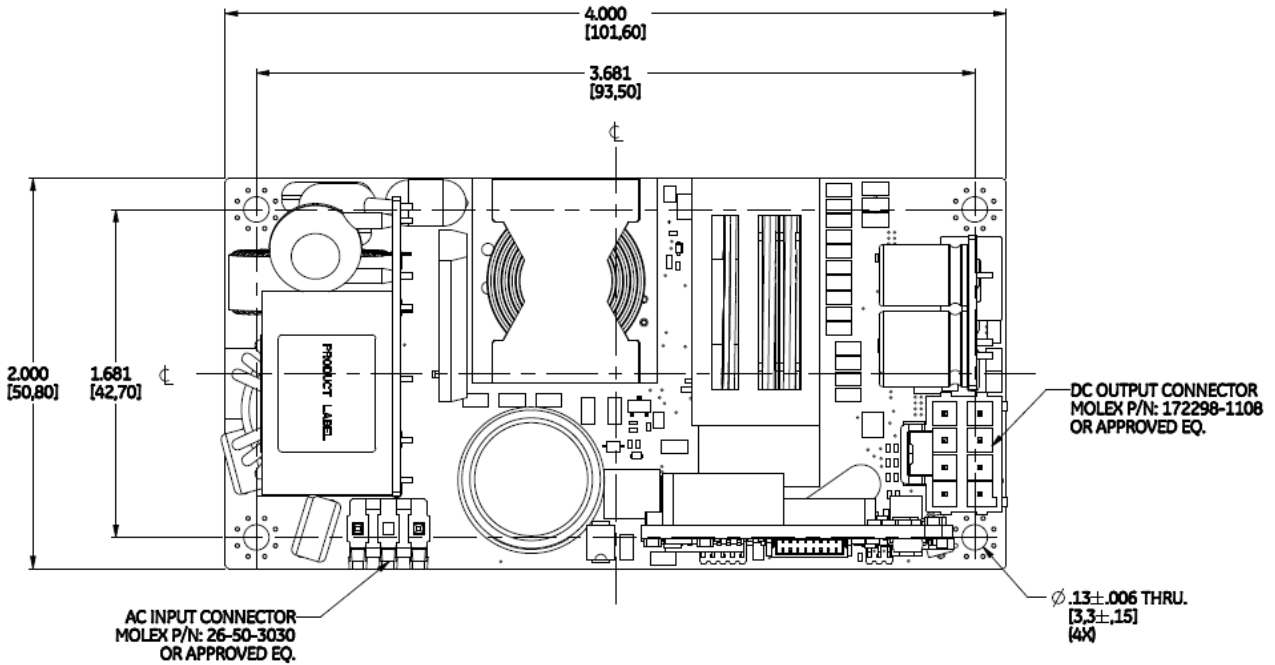

Mounting hardware is standard metric M3, and the mounting holes are 3.3mm diameter.

SIDE VIEW

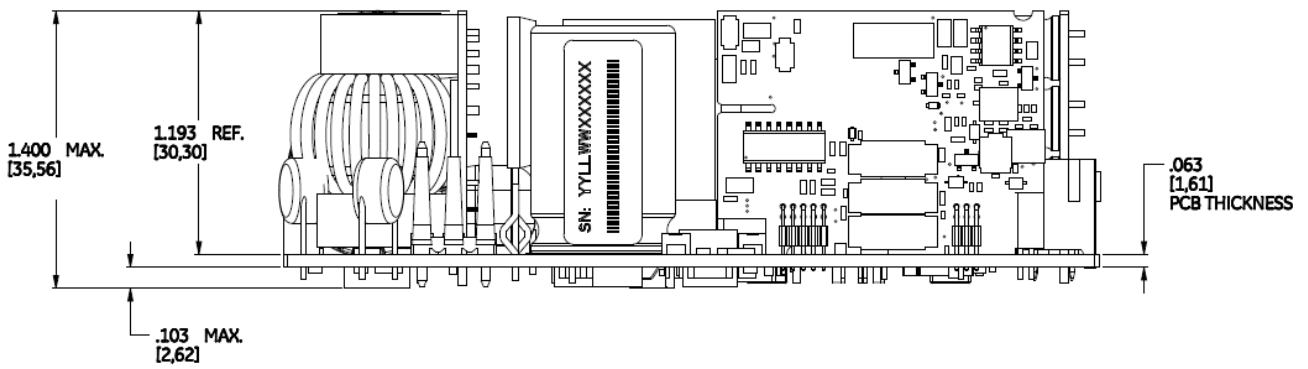

CLP0205 Open Frame Power Supply
 90 - 265Vac input; 5Vdc output; 200W Output Power

BOTTOM VIEW

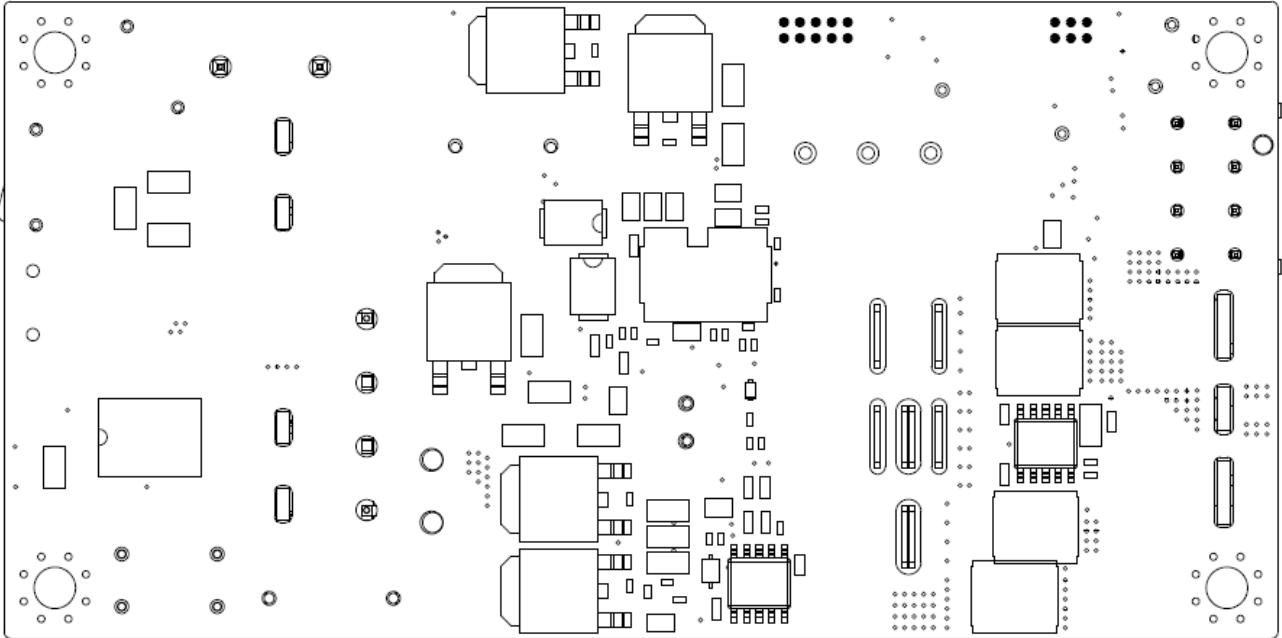

The CLP0205 is fastened to standard M3 pillars by standard M3 screws. We recommend a type with a captive anti-vibration washer, and here just as an example.

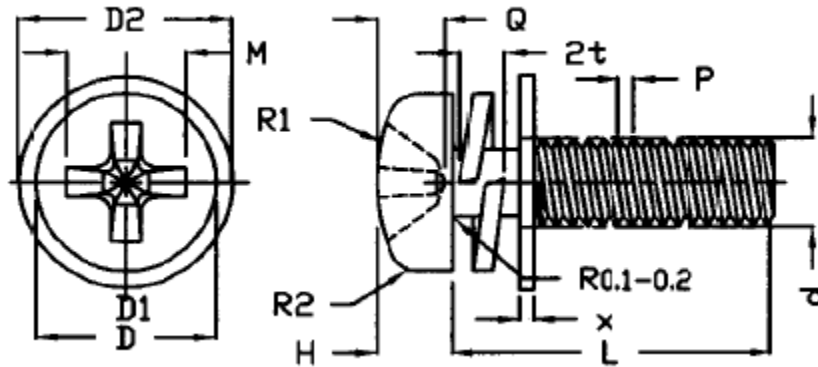

DIMENSIONS OF SCREW										"+ " HOLE			FLATWASHER				SPRING WASHER				
d±0.1	P±0.1	D±0.1	H±0.15	R1±0.3	R2±0.3	L±0.5	MAT.	SURFACE TREATMENT	(MAX)	M	Q	N	d2±0.3	x±0.1	MAT.	SURFACE TREATMENT	d1 (MAX)	d2 (MIN)	h (MIN)	MAT.	SURFACE TREATMENT
Ø3±0.1	0.5	5.5	2	7	1	7	S20C	MFZnI-C		3.5	0.86-1.43	2	6	0.6	SPCC	MFZnI-C	5.5	1.1x0.7	1.2	SWRH57A	MFZnI-C

CLP0205 Open Frame Power Supply
 90 - 265Vac input; 5Vdc output; 200W Output Power

Wiring Accessories

ABB offers a wiring kit, as per table 1 (Device Codes). And the leads of CLP0205 are similar to below.

Wire 1 – AC input – example of similar lead for illustration purposes only (CLP0205 lead uses positions 1 and 3, with 2 omitted for creepage and clearance purposes)

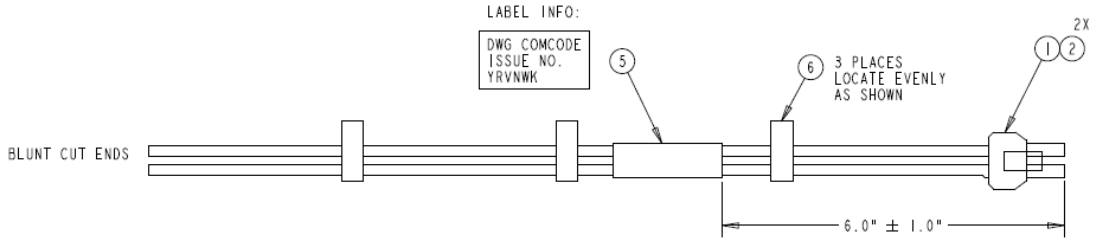

Wire 2 – DC Power output – example of similar lead for illustration purposes only (CLP0205 lead has 8 wires, due to its high output current)

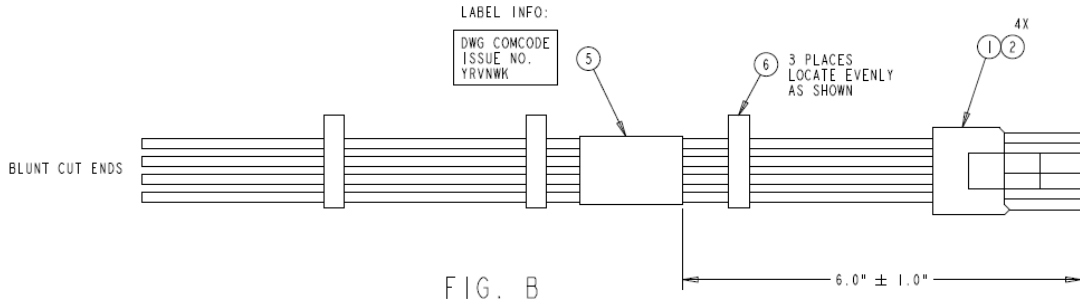

Wire 3 – Controls and Signals – example of similar lead for illustration purposes only

CLP0205 Open Frame Power Supply
 90 - 265Vac input; 5Vdc output; 200W Output Power

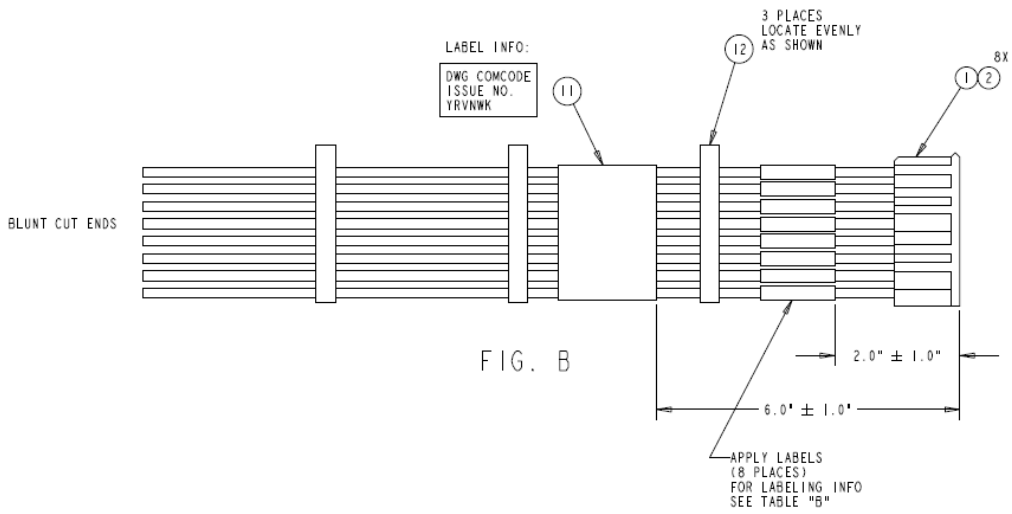

Cover Accessory

ABB offers a cover, as per table 1 (Device Codes). It is similar to this drawing, which is shown for illustration purposes only. The CLP0205 cover is to protect a user, while still allowing cooling air to flow. Below is a general idea for what it looks like.

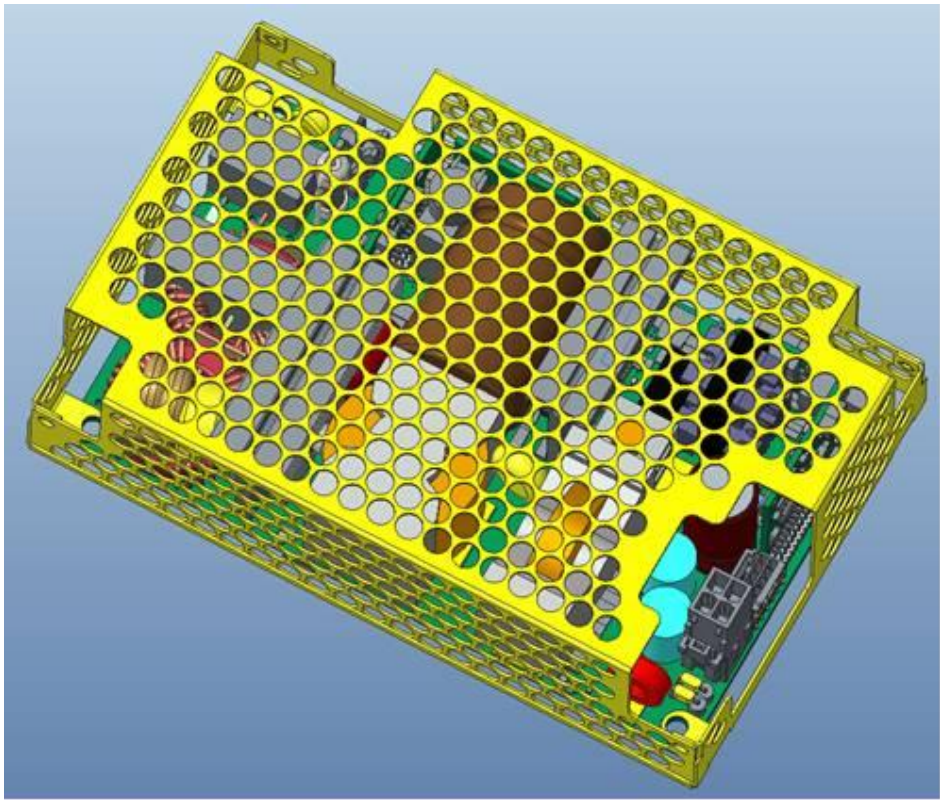

CLP0205 Open Frame Power Supply

90 - 265Vac input; 5Vdc output; 200W Output Power

Connector Information

Connector	Connector on Power Supply	Mating Connector
AC Input Connector (HDR200)	Molex 26-50-3030	Molex 09-50-8031 or equivalent
DC Output Connector (HDR500)	Molex 172298-1108	Molex 172258-1108 or equivalent
Auxiliary Connector (HDR302)	Cvilux CI1408M1HRC-NH	Cvilux CI1408S000A-NH or equivalent

See the lead kit in table 1.

Pinout Information

AC Input Connector (HDR200)		DC Output Connector (HDR500)		Auxiliary Connector (HDR302)	
1 - Neutral		1 - Vout -ve	5 - Vout +ve	1 - 12V standby +ve	5 - Remote Sense +ve
		2 - Vout -ve	6 - Vout +ve	2 - 12V standby -ve	6 - Remote Sense -ve
3 - Live		3 - Vout -ve	7 - Vout +ve	3 - N/A	7 - Current Share
		4 - Vout -ve	8 - Vout +ve	4 - Output OK	8 - Not Connected

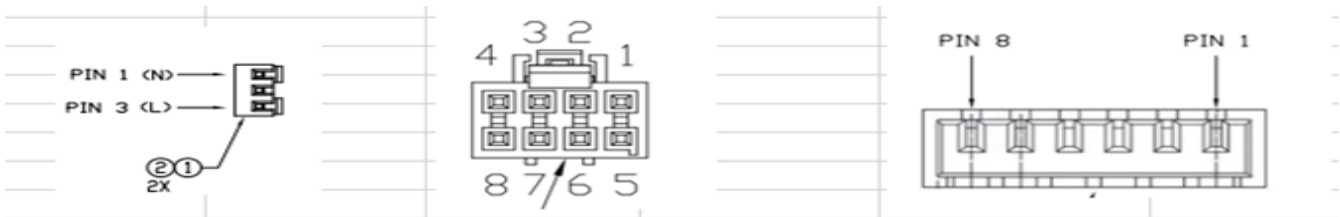

CLP0205 Open Frame Power Supply

90 - 265Vac input; 5Vdc output; 200W Output Power

Ordering Information

Please contact your ABB Sales Representative for pricing, availability and optional features.

Table 1. Device Codes

Device Code	Input Voltage Range	Output Voltage	Output Current	On/Off Control	Standby Supply	Temperature Range	Comcodes
CLP0205FPXXXZ01A	90 – 265Vac	5.0Vdc	40A	Negative Logic	12V @ 0.1A	-40 to 70°C	CLP0205FPXXXZ01A
CLP0205FPCVRZ01A	Metal cover accessory	NA	NA	NA	NA	NA	CLP0205FPCVRZ01A
CLP0205FPKITZ01A	50cm lead kit	NA	NA	NA	NA	-40 to 70°C	CLP0205FPKITZ01A



Contact Us

For more information, call us at

USA/Canada:

+1 888 546 3243, or +1 972 244 9288

Asia-Pacific:

+86-21-53899666

Europe, Middle-East and Africa:

+49.89.878067-280

Go.ABB/Industrial