

LM4855 Boomer® Audio Power Amplifier Series **Integrated Audio Amplifier System**

Check for Samples: [LM4855](#)

FEATURES

- **1.1W (Typ) Output Power with 8Ω Mono BTL Load**
- **115mW (Typ) Output Power with Stereo 32Ω BTL Loads**
- **SPI Programmable 32 Step Digital Volume Control**
- **Eight Distinct Output Modes**
- **DSBGA and WQFN Surface Mount Packaging**
- **"Click and Pop" Suppression Circuitry**
- **Thermal Shutdown Protection**
- **Low Shutdown Current (0.1uA, Typ)**

KEY SPECIFICATIONS

- **THD+N at 1kHz, 1.1W into 8Ω BTL: 1.0% (Typ)**
- **THD+N at 1kHz, 115mW into 32Ω BTL: 0.5% (Typ)**
- **Single Supply Operation: 2.6 to 5.0V**

APPLICATIONS

- **Mobile Phones**
- **PDAs**

DESCRIPTION

The LM4855 is an audio power amplifier system capable of delivering 1.1W (typ) of continuous average power into a mono 8Ω bridged-tied load (BTL) with 1% THD+N and 115mW (typ) per channel of continuous average power into stereo 32Ω BTL loads with 0.5% THD+N, using a 5V power supply.

The LM4855 features a 32 step digital volume control and eight distinct output modes. The digital volume control and output modes are programmed through a three-wire SPI serial control interface, that allows flexibility in routing and mixing audio channels.

The LM4855 is designed for cellular phone, PDA, and other portable handheld applications. It delivers high quality output power from a surface-mount package and requires only six external components.

The industry leading DSBGA package only utilizes 2mm x 2.3mm of PCB space, making the LM4855 the most space efficient audio sub system available today.



Please be aware that an important notice concerning availability, standard warranty, and use in critical applications of Texas Instruments semiconductor products and disclaimers thereto appears at the end of this data sheet.

All trademarks are the property of their respective owners.

Typical Application

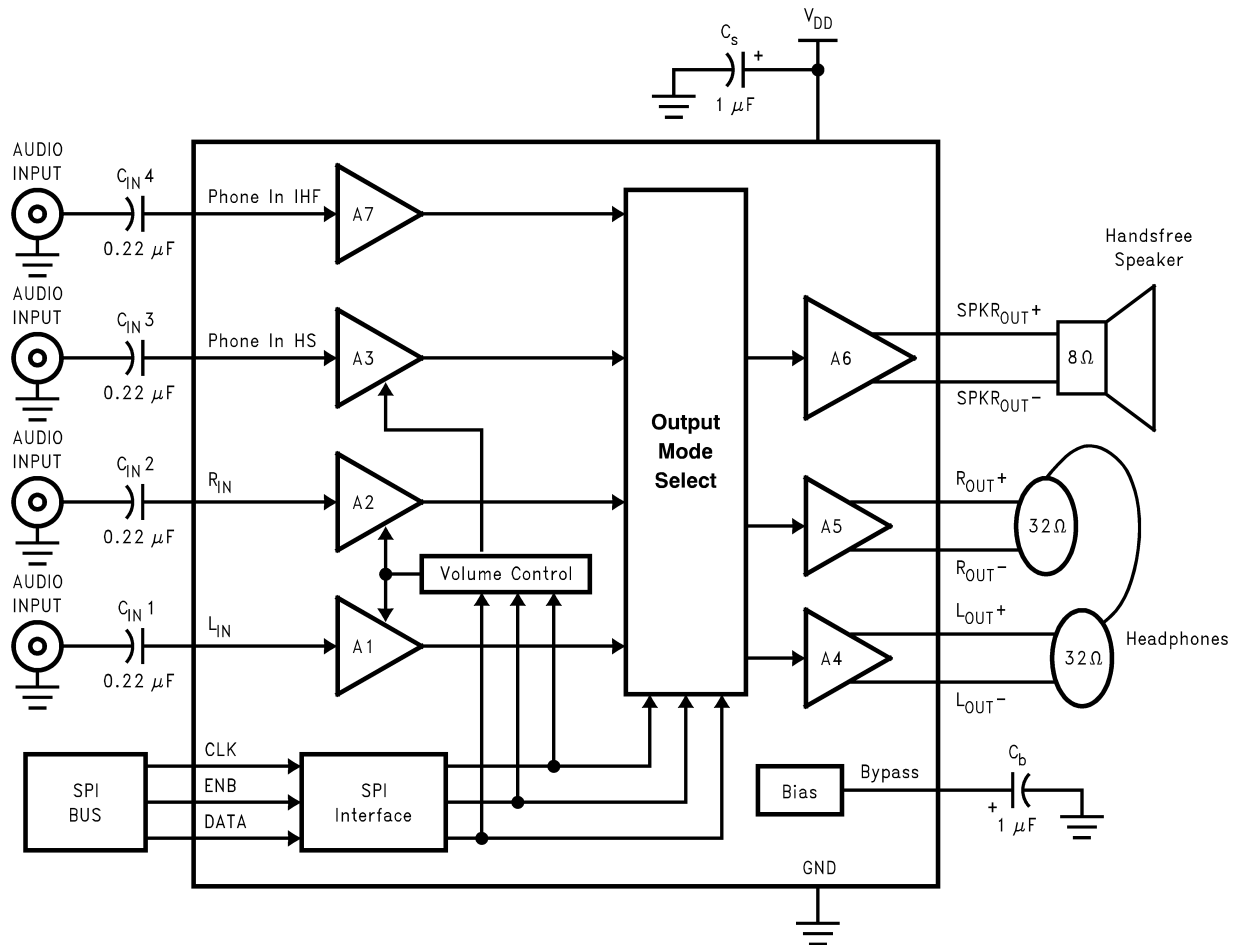

Figure 1. Typical Audio Amplifier Application Circuit

Connection Diagrams

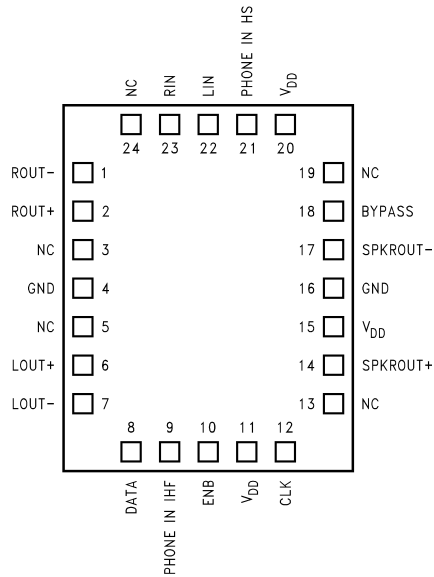

Figure 2. WQFN Package Top View
See Package Number NHW0024A
for Exposed-DAP WQFN

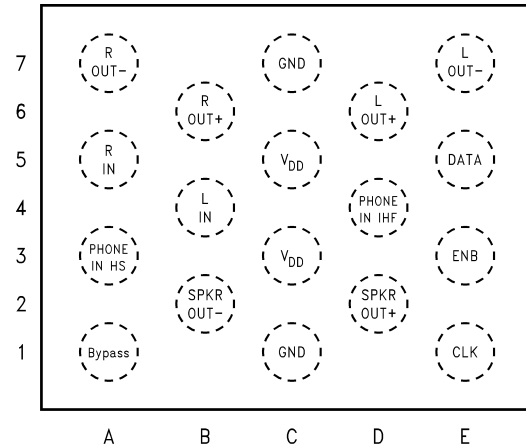

Figure 3. Top View (Bump-Side Down)
See Package Number YZR0018AAA



These devices have limited built-in ESD protection. The leads should be shorted together or the device placed in conductive foam during storage or handling to prevent electrostatic damage to the MOS gates.

Absolute Maximum Ratings⁽¹⁾⁽²⁾

Supply Voltage		6.0V
Storage Temperature		-65°C to +150°C
ESD Susceptibility ⁽³⁾		2.0kV
ESD Machine model ⁽⁴⁾		200V
Junction Temperature (T _J)		150°C
Solder Information	Vapor Phase (60 sec.)	215°C
	Infrared (15 sec.)	220°C
Thermal Resistance	θ _{JA} (typ) - NHW0024A	42°C/W
	θ _{JC} (typ) - NHW0024A	3.0°C/W
	θ _{JA} (typ) - YZR0018AAA	48°C/W ⁽⁵⁾
	θ _{JC} (typ) - YZR0018AAA	23°C/W ⁽⁵⁾

- (1) Absolute Maximum Ratings indicate limits beyond which damage to the device may occur.
- (2) If Military/Aerospace specified devices are required, please contact the Texas Instruments Sales Office/ Distributors for availability and specifications.
- (3) Human body model, 100pF discharged through a 1.5kΩ resistor.
- (4) Machine Model ESD test is covered by specification EIAJ IC-121-1981. A 200pF cap is charged to the specified voltage, then discharged directly into the IC with no external series resistor (resistance of discharge path must be under 50Ω).
- (5) The given θ_{JA} and θ_{JC} are for an LM4855 mounted on a demonstration board with a 4in² area of 1oz printed circuit board copper ground plane.

Operating Ratings⁽¹⁾

Temperature Range	-40°C to 85°C
Supply Voltage V _{DD}	2.6V ≤ V _{DD} ≤ 5.0V

- (1) Operating Ratings indicate conditions for which the device is functional, but do not ensure specific performance limits. For ensured specifications and test conditions, see the Electrical Characteristics. The ensured specifications apply only for the test conditions listed. Some performance characteristics may degrade when the device is not operated under the listed test conditions.

5V Electrical Characteristics⁽¹⁾⁽²⁾

The following specifications apply for $V_{DD} = 5.0V$, $T_A = 25^\circ C$ unless otherwise specified.

Symbol	Parameter	Conditions	LM4855		Units (Limits)
			Typical ⁽³⁾	Limits ⁽⁴⁾	
I_{DD}	Supply Current	Output mode 1 $V_{IN} = 0V$; No loads	5.7	8	mA (max)
		Output mode 1 $V_{IN} = 0V$; Loaded (Fig.1)	6.7	9	mA (max)
		Output modes 2, 3, 4, 5, 6, 7 $V_{IN} = 0V$; No loads	7.5	11	mA (max)
		Output modes 2, 3, 4, 5, 6, 7 $V_{IN} = 0V$; Loaded (Fig. 1)	8.5	12	mA (max)
I_{SD}	Shutdown Current	Output mode 0	0.1	2.0	μA (max)
V_{OS}	Output Offset Voltage	$V_{IN} = 0V$	5.0	40	mV (max)
P_O	Output Power	SPKR _{OUT} ; $R_L = 4\Omega$ THD+N = 1%; $f = 1kHz$, LM4855LQ	1.5		W
		SPKR _{OUT} ; $R_L = 8\Omega$ THD+N = 1%; $f = 1kHz$	1.1	0.8	W (min)
		R_{OUT} and L_{OUT} ; $R_L = 32\Omega$ THD+N = 0.5%; $f = 1kHz$	115	70	mW (min)
THD+N	Total Harmonic Distortion Plus Noise	SPKR _{OUT} $f = 20Hz$ to $20kHz$ $P_{OUT} = 400mW$; $R_L = 8\Omega$	0.5		%
		R_{OUT} and L_{OUT} $f = 20Hz$ to $20kHz$ $P_{OUT} = 50mW$; $R_L = 32\Omega$	0.5		%
N_{OUT}	Output Noise	A-weighted ⁽⁵⁾	29		μV
PSRR	Power Supply Rejection Ratio SPKR _{OUT}	$V_{RIPPLE} = 200mV_{PP}$; $f = 217Hz$, $C_B = 1.0\mu F$ All audio inputs terminated into 50Ω ; Output referred Gain (BTL) = 12dB Output Mode 1, 3, 5, 7	57	54	dB (min)
		$V_{RIPPLE} = 200mV_{PP}$; $f = 217Hz$, $C_B = 1.0\mu F$ All audio inputs terminated into 50Ω ; Output referred Maximum gain setting			
	Power Supply Rejection Ratio R_{OUT} and L_{OUT}	Output Mode 2, 3	62	59	dB (min)
		Output Mode 4, 5	57	54	dB (min)
		Output Mode 6, 7	54	51	dB (min)
V_{IH}	Logic High Input Voltage		1.4 V_{DD}	V (min) V (max)	
V_{IL}	Logic Low Input Voltage		0.4 GND	V (max) V (min)	

- (1) Operating Ratings indicate conditions for which the device is functional, but do not ensure specific performance limits. For ensured specifications and test conditions, see the Electrical Characteristics. The ensured specifications apply only for the test conditions listed. Some performance characteristics may degrade when the device is not operated under the listed test conditions.
- (2) All voltages are measured with respect to the ground pin, unless otherwise specified.
- (3) Typical specifications are specified at $+25^\circ C$ and represent the most likely parametric norm.
- (4) Tested limits are ensured to AOQL (Average Outgoing Quality Level).
- (5) Please refer to the [Output Noise vs Output Mode](#) table in the [Typical Performance Characteristics](#) section for more details.

5V Electrical Characteristics⁽¹⁾⁽²⁾ (continued)

 The following specifications apply for $V_{DD} = 5.0V$, $T_A = 25^\circ C$ unless otherwise specified.

Symbol	Parameter	Conditions	LM4855		Units (Limits)
			Typical ⁽³⁾	Limits ⁽⁴⁾	
	Digital Volume Range (R_{IN} and L_{IN})	Input referred minimum gain	-34.5	-35.1 -33.9	dB (min) dB (max)
		Input referred maximum gain	12.0	11.4 12.6	dB (min) dB (max)
	Digital Volume Stepsize		1.5		dB
	Digital Volume Stepsize Error		± 0.1	± 0.6	dB (max)
	Phone_In_IHF Volume	BTL gain from Phone_In_IHF to SPKR _{OUT}	12	11.4 12.6	dB (min) dB (max)
	Phone_In_IHF Mute Attenuation	Output Mode 2, 4, 6	80	72	dB (min)
	Phone_In_IHF Input Impedance		20	15 25	k Ω (min) k Ω (max)
	Phone_In_HS Input Impedance	Maximum gain setting	50	37.5 62.5	k Ω (min) k Ω (max)
		Minimum gain setting	100	75 125	k Ω (min) k Ω (max)
	R_{IN} and L_{IN} Input Impedance	Maximum gain setting	33.5	25 42	k Ω (min) k Ω (max)
		Minimum gain setting	100	75 125	k Ω (min) k Ω (max)
t_{SD}	Thermal Shutdown Temperature		170	150	$^\circ C$ (min)
t_{ES}	Enable Setup Time (ENB)			20	ns (min)
t_{EH}	Enable Hold Time (ENB)			20	ns (min)
t_{EL}	Enable Low Time (ENB)			30	ns (min)
t_{DS}	Data Setup Time (DATA)			20	ns (min)
t_{DH}	Data Hold Time (DATA)			20	ns (min)
t_{CS}	Clock Setup Time (CLK)			20	ns (min)
t_{CH}	Clock Logic High Time (CLK)			50	ns (min)
t_{CL}	Clock Logic Low Time (CLK)			50	ns (min)
f_{CLK}	Clock Frequency			DC 10	(min) MHz (max)

3V Electrical Characteristics⁽¹⁾⁽²⁾

The following specifications apply for $V_{DD} = 3.0V$, $T_A = 25^\circ C$ unless otherwise specified.

Symbol	Parameter	Conditions	LM4855		Units (Limits)
			Typical ⁽³⁾	Limits ⁽⁴⁾	
I_{DD}	Supply Current	Output mode 1 $V_{IN} = 0V$; No loads	4.5	7	mA (max)
		Output mode 1 $V_{IN} = 0V$; Loaded (Fig.1)	5.0	8	mA (max)
		Output modes 2, 3, 4, 5, 6, 7 $V_{IN} = 0V$; No loads	6.5	10	mA (max)
		Output modes 2, 3, 4, 5, 6, 7 $V_{IN} = 0V$; Loaded (Fig. 1)	7	11	mA (max)
I_{SD}	Shutdown Current	Output mode 0	0.1	2.0	μA (max)
V_{OS}	Output Offset Voltage	$V_{IN} = 0V$	5.0	40	mV (max)
P_O	Output Power	SPKR _{OUT} ; $R_L = 4\Omega$ THD+N = 1%; $f = 1kHz$, LM4855LQ	430		mW
		SPKR _{OUT} ; $R_L = 8\Omega$ THD+N = 1%; $f = 1kHz$	340	300	mW (min)
		R_{OUT} and L_{OUT} ; $R_L = 32\Omega$ THD+N = 0.5%; $f = 1kHz$	25	20	mW (min)
THD+N	Total Harmonic Distortion Plus Noise	SPKR _{OUT} $f = 20Hz$ to $20kHz$ $P_{OUT} = 250mW$; $R_L = 8\Omega$	0.5		%
		R_{OUT} and L_{OUT} $f = 20Hz$ to $20kHz$ $P_{OUT} = 20mW$; $R_L = 32\Omega$	0.5		%
N_{OUT}	Output Noise	A-weighted ⁽⁵⁾	29		μV
PSRR	Power Supply Rejection Ratio SPKR _{OUT}	$V_{RIPPLE} = 200mV_{PP}$; $f = 217Hz$, $C_B = 1.0\mu F$ All audio inputs terminated into 50Ω ; Output referred Gain (BTL) = 12dB Output Mode 1, 3, 5, 7	58	55	dB (min)
	Power Supply Rejection Ratio R_{OUT} and L_{OUT}	$V_{RIPPLE} = 200mV_{PP}$; $f = 217Hz$, $C_B = 1.0\mu F$ All audio inputs terminated into 50Ω ; Output referred Maximum gain setting			
		Output Mode 2, 3	63	60	dB (min)
		Output Mode 4, 5	58	55	dB (min)
		Output Mode 6, 7	55	52	dB (min)
V_{IH}	Logic High Input Voltage			1.4 V_{DD}	V (min) V (max)
V_{IL}	Logic Low Input Voltage			0.4 GND	V (max) V (min)

(1) Absolute Maximum Ratings indicate limits beyond which damage to the device may occur.

(2) All voltages are measured with respect to the ground pin, unless otherwise specified.

(3) Typical specifications are specified at $+25^\circ C$ and represent the most likely parametric norm.

(4) Tested limits are ensured to AOQL (Average Outgoing Quality Level).

(5) Please refer to the [Output Noise vs Output Mode](#) table in the [Typical Performance Characteristics](#) section for more details.

3V Electrical Characteristics⁽¹⁾⁽²⁾ (continued)

The following specifications apply for $V_{DD} = 3.0V$, $T_A = 25^\circ C$ unless otherwise specified.

Symbol	Parameter	Conditions	LM4855		Units (Limits)
			Typical ⁽³⁾	Limits ⁽⁴⁾	
	Digital Volume Range (R_{IN} and L_{IN})	Input referred minimum gain	-34.5	-35.1 -33.9	dB (min) dB (max)
		Input referred maximum gain	12.0	11.4 12.6	dB (min) dB (max)
	Digital Volume Stepsize		1.5		dB
	Digital Volume Stepsize Error		± 0.1	± 0.6	dB (max)
	Phone_In_IHF Volume	BTL gain from Phone_In_IHF to SPKR _{OUT}	12	11.4 12.6	dB (min) dB (max)
	Phone_In_IHF Mute Attenuation	Output Mode 2, 4, 6	80	72	dB (min)
	Phone_In_IHF Input Impedance		20	15 25	k Ω (min) k Ω (max)
	Phone_In_HS Input Impedance	Maximum gain setting	50	37.5 62.5	k Ω (min) k Ω (max)
		Minimum gain setting	100	75 125	k Ω (min) k Ω (max)
	R_{IN} and L_{IN} Input Impedance	Maximum gain setting	33.5	25 42	k Ω (min) k Ω (max)
		Minimum gain setting	100	75 125	k Ω (min) k Ω (max)
t_{SD}	Thermal Shutdown Temperature		170	150	$^\circ C$ (min)
t_{ES}	Enable Setup Time (ENB)			20	ns (min)
t_{EH}	Enable Hold Time (ENB)			20	ns (min)
t_{EL}	Enable Low Time (ENB)			30	ns (min)
t_{DS}	Data Setup Time (DATA)			20	ns (min)
t_{DH}	Data Hold Time (DATA)			20	ns (min)
t_{CS}	Clock Setup Time (CLK)			20	ns (min)
t_{CH}	Clock Logic High Time (CLK)			50	ns (min)
t_{CL}	Clock Logic Low Time (CLK)			50	ns (min)
f_{CLK}	Clock Frequency			DC 10	(min) MHz (max)

External Components Description

Components		Functional Description
1.	C_{IN}	This is the input coupling capacitor. It blocks the DC voltage and couples the input signal to the amplifier's input terminals. C_{IN} also creates a highpass filter with the internal resistor R_i (Input Impedance) at $f_c = 1/(2\pi R_i C_{IN})$.
2.	C_S	This is the supply bypass capacitor. It filters the supply voltage applied to the V_{DD} pin and helps maintain the LM4855's PSRR.
3.	C_B	This is the BYPASS pin capacitor. It filters the $V_{DD} / 2$ voltage and helps maintain the LM4855's PSRR.

Typical Performance Characteristics

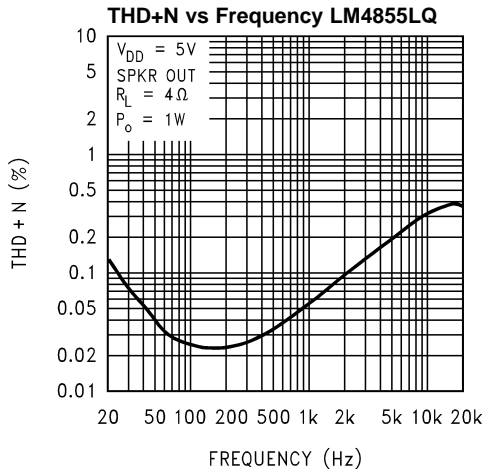

Figure 4.

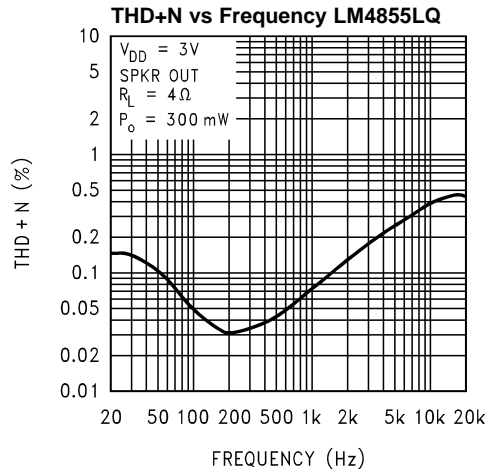

Figure 5.

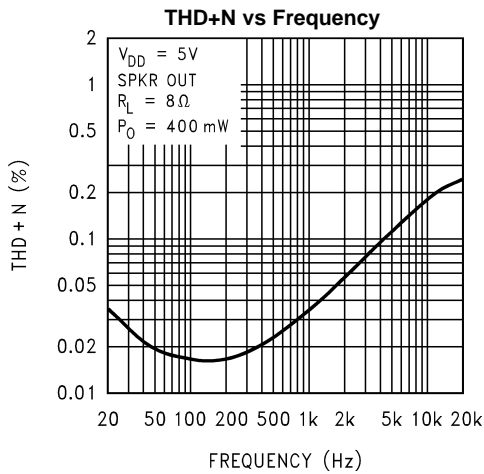

Figure 6.

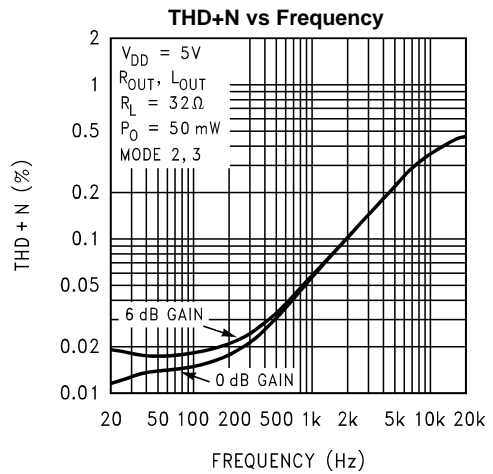

Figure 7.

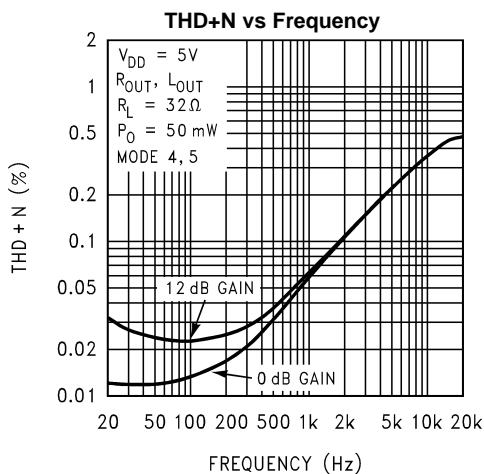

Figure 8.

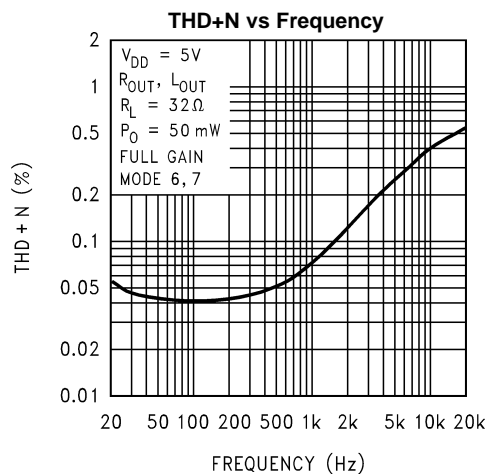

Figure 9.

Typical Performance Characteristics (continued)

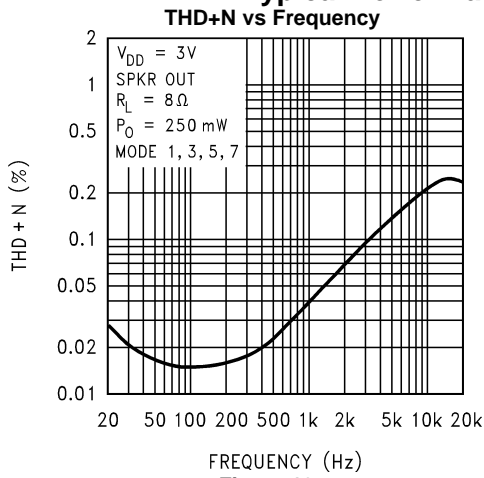

Figure 10.

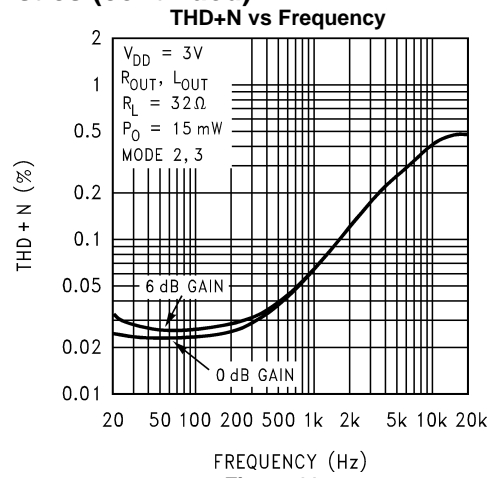

Figure 11.

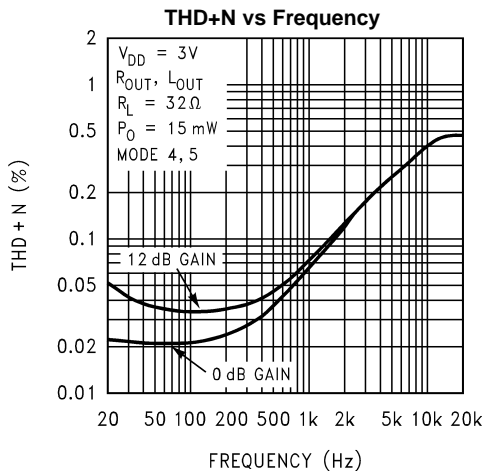

Figure 12.

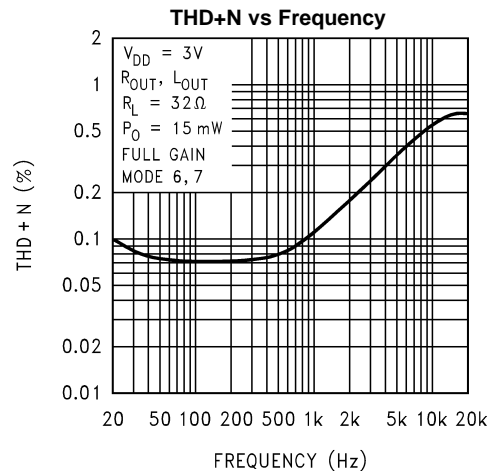

Figure 13.

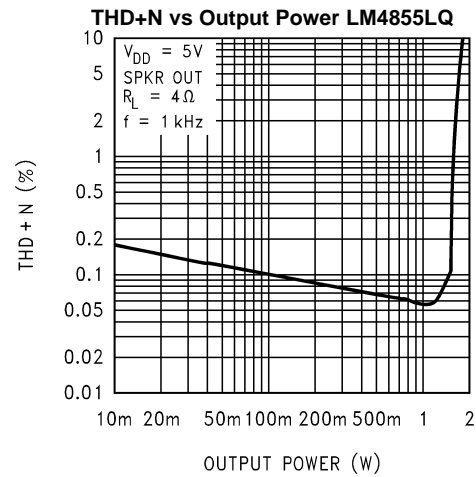

Figure 14.

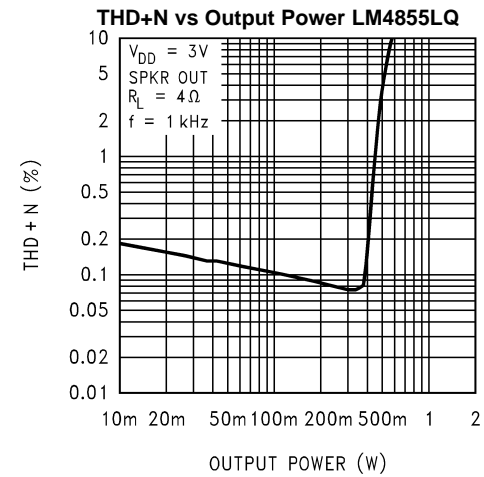

Figure 15.

Typical Performance Characteristics (continued)

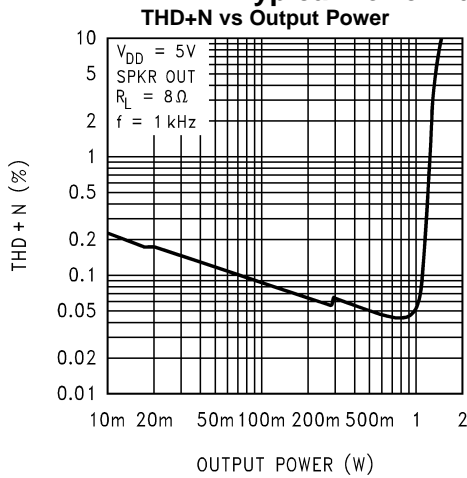

Figure 16.

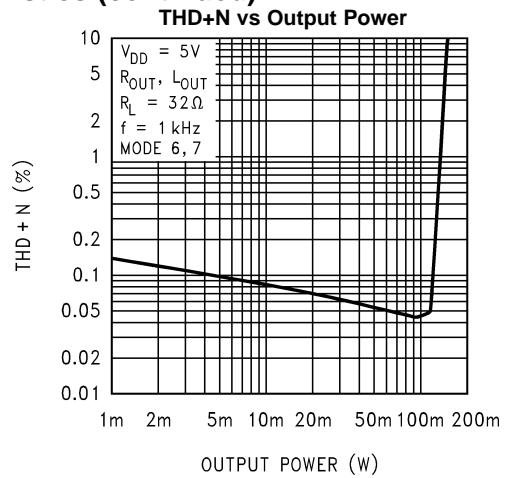

Figure 17.

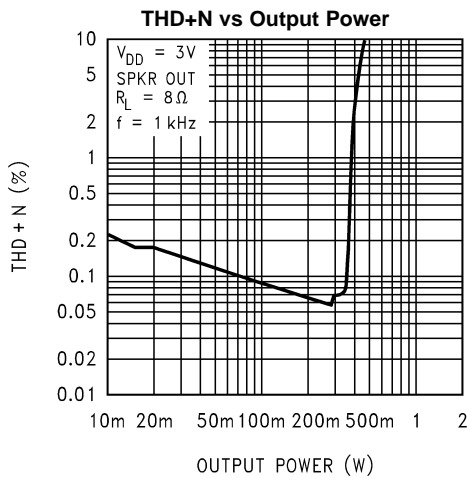

Figure 18.

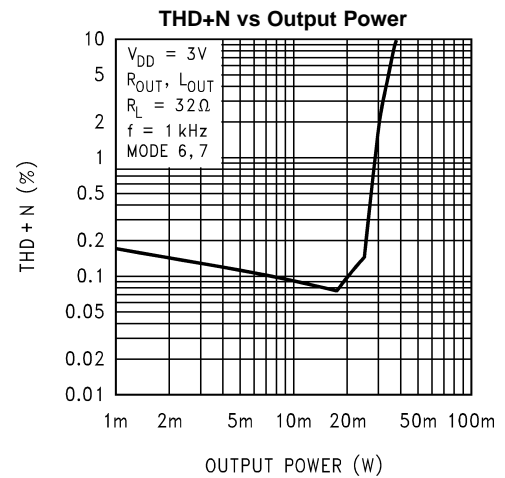

Figure 19.

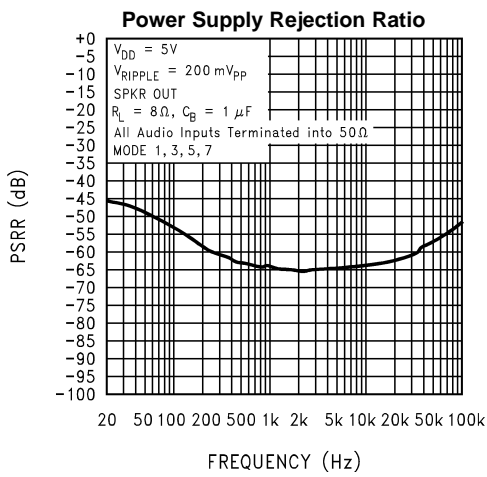

Figure 20.

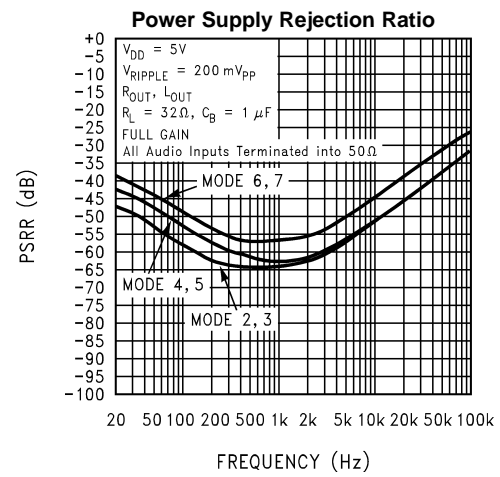

Figure 21.

Typical Performance Characteristics (continued)

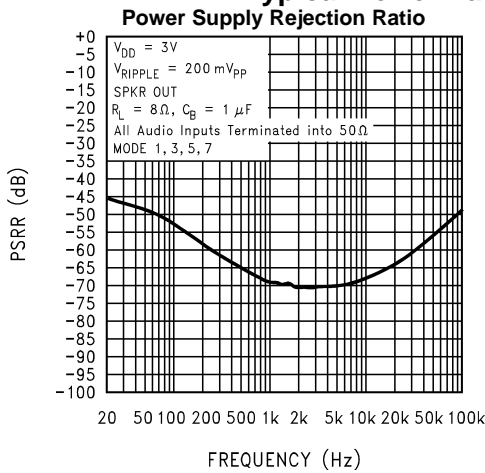

Figure 22.

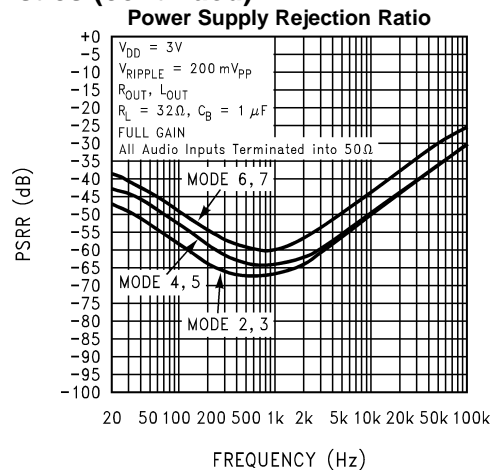

Figure 23.

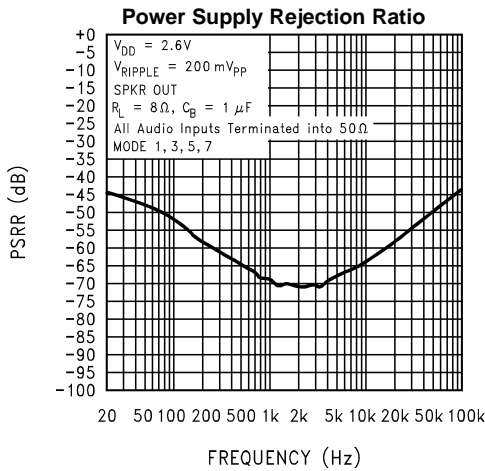

Figure 24.

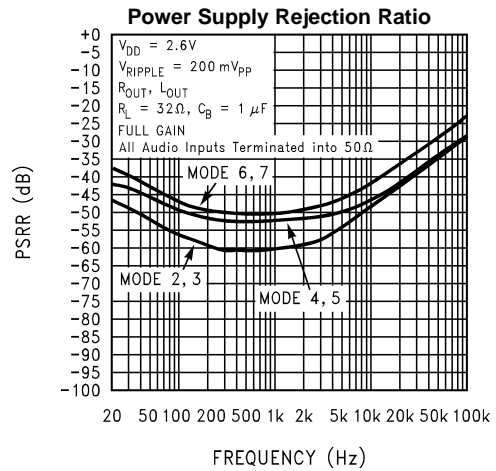

Figure 25.

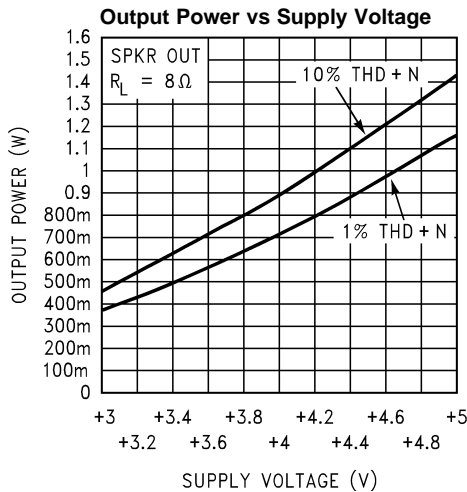

Figure 26.

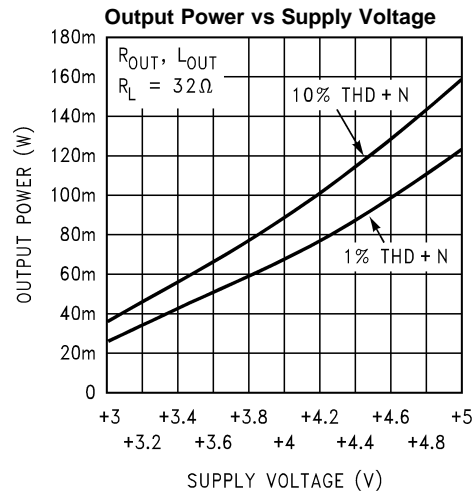

Figure 27.

Typical Performance Characteristics (continued)

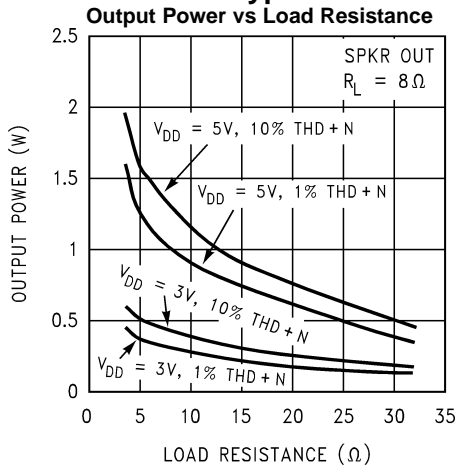

Figure 28.

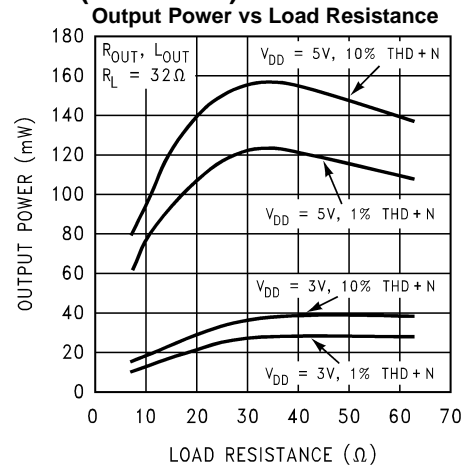

Figure 29.

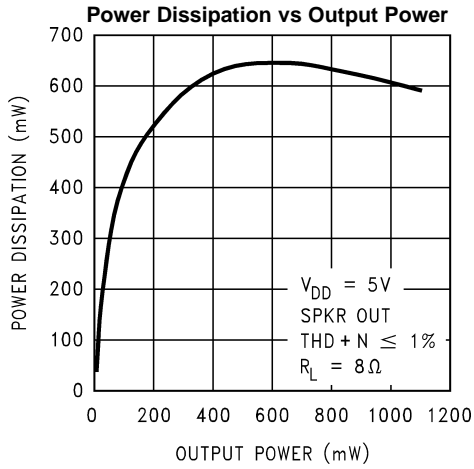

Figure 30.

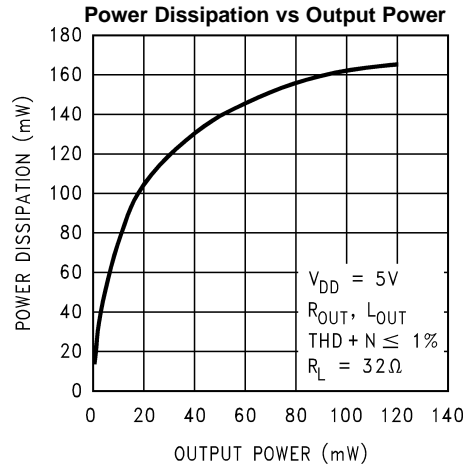

Figure 31.

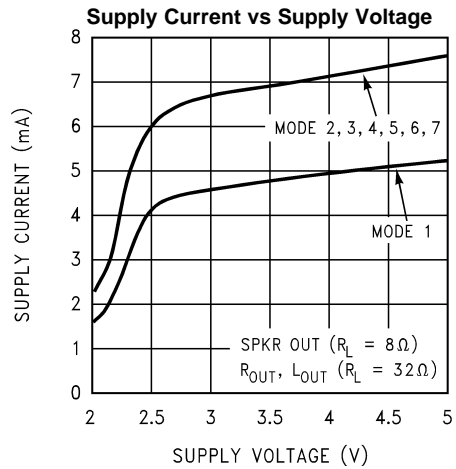

Figure 32.

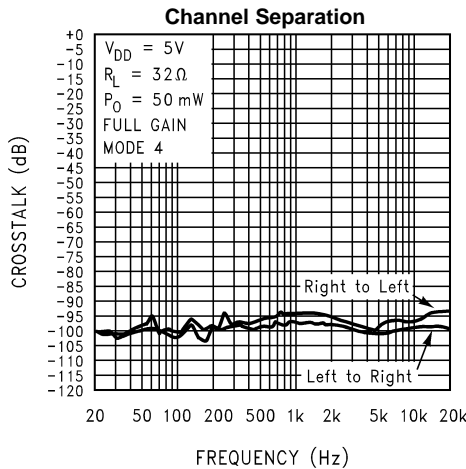

Figure 33.

Typical Performance Characteristics (continued)

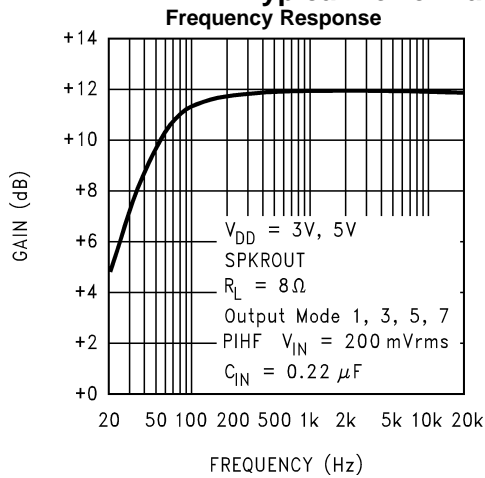

Figure 34.

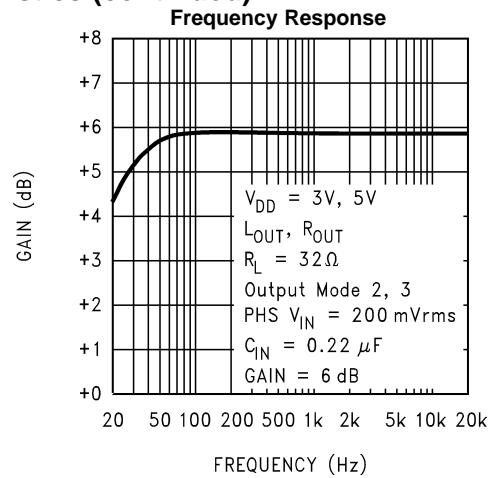

Figure 35.

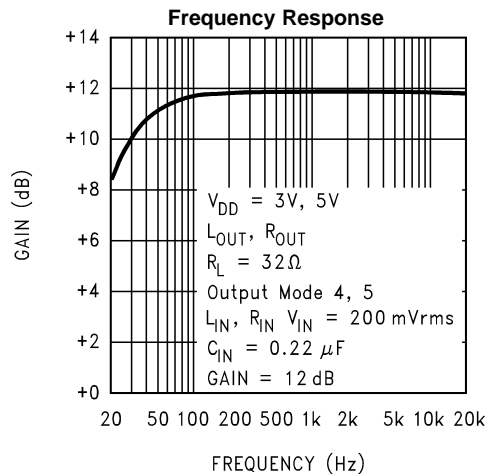

Figure 36.

Table 1. Output Noise vs Output Mode ($V_{DD} = 3V, 5V$)⁽¹⁾⁽²⁾⁽³⁾

Output Mode	SPKRROUT Output Noise (μV)	LOUT/ROUT Output Noise (μV)
1	29	X
2	X	28 (G1 = 0dB) 31 (G1 = 6dB)
3	29	28 (G1 = 0dB) 31 (G1 = 6dB)
4	X	28 (G2 = 0dB) 38 (G2 = 12dB)
5	29	28(G2 = 0dB) 38 (G2 = 12dB)
6	X	38 (G2 = 0dB) 41 (G1 = 0dB) 48 (G1 = 6dB)
7	29	38 (G2 = 0dB) 41 (G1 = 0dB) 48 (G1 = 6dB)

(1) G1 = gain from P_{HS} to LOUT/ROUT
 (2) G2 = gain from LIN/RIN to LOUT/ROUT
 (3) A - weighted filter used

APPLICATION INFORMATION

SPI PIN DESCRIPTION

DATA: This is the serial data input pin.

CLK: This is the clock input pin.

ENB: This is the SPI enable pin and is active-high.

SPI OPERATION DESCRIPTION

The serial data bits are organized into a field which contains 8 bits of data defined by [Table 2](#). The Data 0 to Data 2 bits determine the output mode of the LM4855 as shown in [Table 3](#). The Data 3 to Data 7 bits determine the volume level setting as illustrated by [Table 4](#). For each SPI transfer, the data bits are written to the DATA pin with the least significant bit (LSB) first. All serial data are sampled at the rising edge of the CLK signal. Once all the data bits have been sampled, ENB transitions from logic-high to logic-low to complete the SPI sequence. All 8 bits must be received before any data latch can occur. Any excess CLK and DATA transitions will be ignored after the eighth rising clock edge has occurred. For any data sequence longer than 8 bits, only the first 8 bits will get loaded into the shift register and the rest of the bits will be disregarded.

Table 2. Bit Allocation

Data 0	Mode Select
Data 1	Mode Select
Data 2	Mode Select
Data 3	Volume Control
Data 4	Volume Control
Data 5	Volume Control
Data 6	Volume Control
Data 7	Volume Control

Table 3. Output Mode Selection⁽¹⁾

Output Mode #	Data 2	Data 1	Data 0	SPK _{ROUT}	R _{OUT}	L _{OUT}
0	0	0	0	SD	SD	SD
1	0	0	1	12dB x P _{IHF}	SD	SD
2	0	1	0	MUTE	G1 x P _{HS}	G1 x P _{HS}
3	0	1	1	12dB x P _{IHF}	G1 x P _{HS}	G1 x P _{HS}
4	1	0	0	MUTE	G2 x R	G2 x L
5	1	0	1	12dB x P _{IHF}	G2 x R	G2 x L
6	1	1	0	MUTE	(G1 x P _{HS}) + (G2 x R)	(G1 x P _{HS}) + (G2 x L)
7	1	1	1	12dB x P _{IHF}	(G1 x P _{HS}) + (G2 x R)	(G1 x P _{HS}) + (G2 x L)

- (1) R = Rin
 L = Lin
 P_{IHF} = Phone_In_IHF
 P_{HS} = Phone_In_HS
 SD = Shutdown Mode
 MUTE = Mute Mode
 G1 = gain from P_{HS} to LOUT/ROUT
 G2 = gain from LIN/ RIN to LOUT/ROUT
 Default Mode upon device power-up is Output Mode 0

Table 4. Volume Control Settings

Gain (dB)		Data 7	Data 6	Data 5	Data 4	Data 3
G2	G1					
R _{IN} , L _{IN} to R _{OUT} , L _{OUT}	Phone_In_HS to R _{OUT} , L _{OUT}					
-34.5	-40.5	0	0	0	0	0
-33.0	-39.0	0	0	0	0	1
-31.5	-37.5	0	0	0	1	0
-30.0	-36.0	0	0	0	1	1
-28.5	-34.5	0	0	1	0	0
-27.0	-33.0	0	0	1	0	1
-25.5	-31.5	0	0	1	1	0
-24.0	-30.0	0	0	1	1	1
-22.5	-28.5	0	1	0	0	0
-21.0	-27.0	0	1	0	0	1
-19.5	-25.5	0	1	0	1	0
-18.0	-24.0	0	1	0	1	1
-16.5	-22.5	0	1	1	0	0
-15.0	-21.0	0	1	1	0	1
-13.5	-19.5	0	1	1	1	0
-12.0	-18.0	0	1	1	1	1
-10.5	-16.5	1	0	0	0	0
-9.0	-15.0	1	0	0	0	1
-7.5	-13.5	1	0	0	1	0
-6.0	-12.0	1	0	0	1	1
-4.5	-10.5	1	0	1	0	0
-3.0	-9.0	1	0	1	0	1
-1.5	-7.5	1	0	1	1	0
0.0	-6.0	1	0	1	1	1
1.5	-4.5	1	1	0	0	0
3.0	-3.0	1	1	0	0	1
4.5	-1.5	1	1	0	1	0
6.0	0	1	1	0	1	1
7.5	1.5	1	1	1	0	0
9.0	3.0	1	1	1	0	1
10.5	4.5	1	1	1	1	0
12.0	6.0	1	1	1	1	1

SPI OPERATIONAL REQUIREMENTS

1. The data bits are transmitted with the LSB first.
2. The maximum clock rate is 10MHz for the CLK pin.
3. CLK must remain logic-high for at least 50ns (t_{CH}) after the rising edge of CLK, and CLK must remain logic-low for at least 50ns (t_{CL}) after the falling edge of CLK.
4. The serial data bits are sampled at the rising edge of CLK. Any transition on DATA must occur at least 20ns (t_{DS}) before the rising edge of CLK. Also, any transition on DATA must occur at least 20ns (t_{DH}) after the rising edge of CLK and stabilize before the next rising edge of CLK.
5. ENB should be logic-high only during serial data transmission.
6. ENB must be logic-high at least 20ns (t_{ES}) before the first rising edge of CLK, and ENB has to remain logic-high at least 20ns (t_{EH}) after the eighth rising edge of CLK.
7. If ENB remains logic-low for more than 10ns before all 8 bits are transmitted then the data latch will be aborted.
8. If ENB is logic-high for more than 8 CLK pulses then only the first 8 data bits will be latched and activated when ENB transitions to logic-low.
9. ENB must remain logic-low for at least 30ns (t_{EL}) to latch in the data.
10. Coincidental rising or falling edges of CLK and ENB are not allowed. If CLK is to be held logic-high after the data transmission, the falling edge of CLK must occur at least 20ns (t_{CS}) before ENB transitions to logic-high for the next set of data.

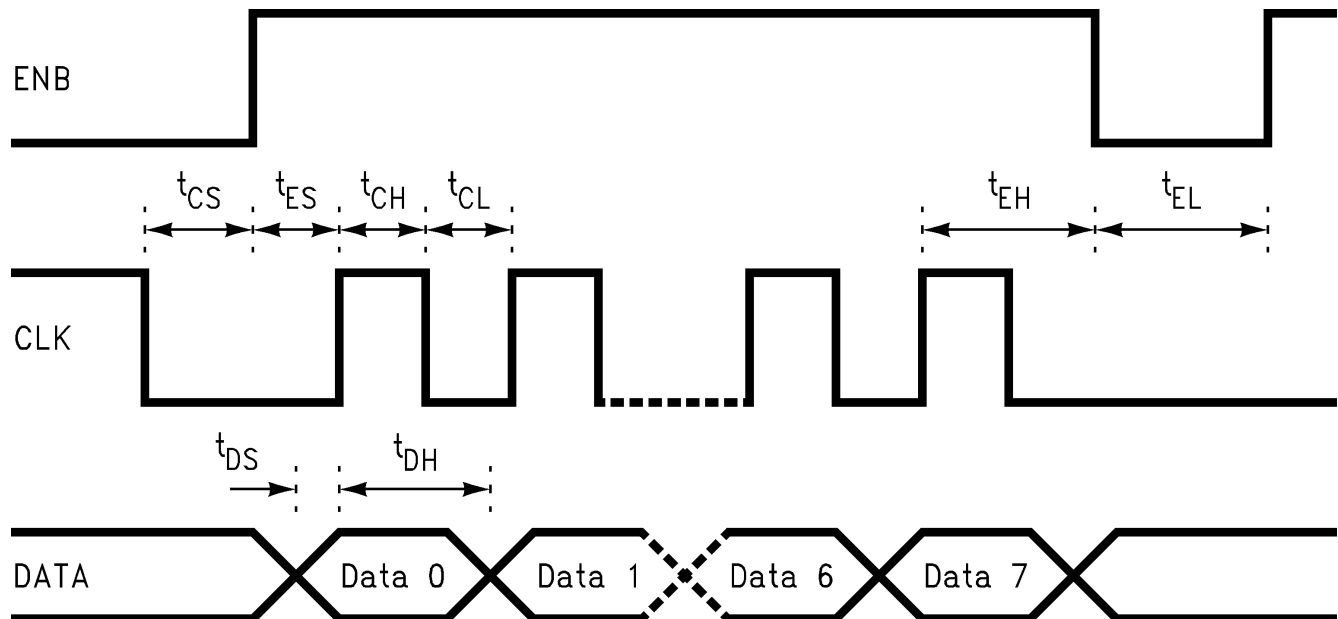

Figure 37. SPI Timing Diagram

EXPOSED-DAP MOUNTING CONSIDERATIONS

The LM4855's exposed-DAP (die attach paddle) package (NHW) provides a low thermal resistance between the die and the PCB to which the part is mounted and soldered. This allows rapid heat transfer from the die to the surrounding PCB copper area heatsink, copper traces, ground plane, and finally, surrounding air. The result is a low voltage audio power amplifier that produces 1.1W dissipation in a 8Ω load at ≤ 1% THD+N. This high power is achieved through careful consideration of necessary thermal design. Failing to optimize thermal design may compromise the LM4855's high power performance and activate unwanted, though necessary, thermal shutdown protection.

The NHW package must have its DAP soldered to a copper pad on the PCB. The DAP's PCB copper pad is then, ideally, connected to a large plane of continuous unbroken copper. This plane forms a thermal mass, heat sink, and radiation area. Place the heat sink area on either outside plane in the case of a two-sided or multi-layer PCB. (The heat sink area can also be placed on an inner layer of a multi-layer board. The thermal resistance, however, will be higher.) Connect the DAP copper pad to the inner layer or backside copper heat sink area with 6 (3 X 2) (NHW) vias. The via diameter should be 0.012in - 0.013in with a 1.27mm pitch. Ensure efficient thermal conductivity by plugging and tenting the vias with plating and solder mask, respectively.

Best thermal performance is achieved with the largest practical copper heat sink area. If the heatsink and amplifier share the same PCB layer, a nominal 2.5in² (min) area is necessary for 5V operation with a 4Ω load. Heatsink areas not placed on the same PCB layer as the LM4855 should be 5in² (min) for the same supply voltage and load resistance. The last two area recommendations apply for 25°C ambient temperature. Increase the area to compensate for ambient temperatures above 25°C. In all circumstances and under all conditions, the junction temperature must be held below 150°C to prevent activating the LM4855's thermal shutdown protection. Further detailed and specific information concerning PCB layout and fabrication and mounting an NHW (WQFN) is found in TI's [AN1187](#).

PCB LAYOUT AND SUPPLY REGULATION CONSIDERATIONS FOR DRIVING 3Ω AND 4Ω LOADS

Power dissipated by a load is a function of the voltage swing across the load and the load's impedance. As load impedance decreases, load dissipation becomes increasingly dependent on the interconnect (PCB trace and wire) resistance between the amplifier output pins and the load's connections. Residual trace resistance causes a voltage drop, which results in power dissipated in the trace and not in the load as desired. For example, 0.1Ω trace resistance reduces the output power dissipated by a 4Ω load from 1.7W to 1.6W. The problem of decreased load dissipation is exacerbated as load impedance decreases. Therefore, to maintain the highest load dissipation and widest output voltage swing, PCB traces that connect the output pins to a load must be as wide as possible.

Poor power supply regulation adversely affects maximum output power. A poorly regulated supply's output voltage decreases with increasing load current. Reduced supply voltage causes decreased headroom, output signal clipping, and reduced output power. Even with tightly regulated supplies, trace resistance creates the same effects as poor supply regulation. Therefore, making the power supply traces as wide as possible helps maintain full output voltage swing.

BRIDGE CONFIGURATION EXPLANATION

As shown in [Figure 1](#), the LM4855 consists of three pairs of output amplifier blocks (A4-A6). A4, A5, and A6 consist of bridged-tied amplifier pairs that drive LOUT, ROUT, and SPKROUT respectively. The LM4855 drives a load, such as a speaker, connected between outputs, SPKROUT+ and SPKROUT-. In the amplifier block A6, the output of the amplifier that drives SPKROUT- serves as the input to the unity gain inverting amplifier that drives SPKROUT+.

This results in both amplifiers producing signals identical in magnitude, but 180° out of phase. Taking advantage of this phase difference, a load is placed between SPKROUT- and SPKROUT+ and driven differentially (commonly referred to as 'bridge mode'). This results in a differential or BTL gain of:

$$A_{VD} = 2(R_f/R_i) = 2 \quad (1)$$

Bridge mode amplifiers are different from single-ended amplifiers that drive loads connected between a single amplifier's output and ground. For a given supply voltage, bridge mode has a distinct advantage over the single-ended configuration: its differential output doubles the voltage swing across the load. Theoretically, this produces four times the output power when compared to a single-ended amplifier under the same conditions. This increase in attainable output power assumes that the amplifier is not current limited and that the output signal is not clipped.

Another advantage of the differential bridge output is no net DC voltage across the load. This is accomplished by biasing SPKROUT- and SPKROUT+ outputs at half-supply. This eliminates the coupling capacitor that single supply, single-ended amplifiers require. Eliminating an output coupling capacitor in a typical single-ended configuration forces a single-supply amplifier's half-supply bias voltage across the load. This increases internal IC power dissipation and may permanently damage loads such as speakers.

POWER DISSIPATION

Power dissipation is a major concern when designing a successful single-ended or bridged amplifier.

A direct consequence of the increased power delivered to the load by a bridge amplifier is higher internal power dissipation. The LM4855 has a pair of bridged-tied amplifiers driving a handsfree speaker, SPKROUT. The maximum internal power dissipation operating in the bridge mode is twice that of a single-ended amplifier. From Equation (2), assuming a 5V power supply and an 8Ω load, the maximum SPKROUT power dissipation is 634mW.

$$P_{\text{DMAX-SPKROUT}} = 4(V_{\text{DD}})^2 / (2\pi^2 R_L): \text{Bridge Mode} \quad (2)$$

The LM4855 also has 2 pairs of bridged-tied amplifiers driving stereo headphones, ROUT and LOUT. The maximum internal power dissipation for ROUT and LOUT is given by equation (3) and (4). From Equations (3) and (4), assuming a 5V power supply and a 32Ω load, the maximum power dissipation for LOUT and ROUT is 158mW, or 316mW total.

$$P_{\text{DMAX-LOUT}} = 4(V_{\text{DD}})^2 / (2\pi^2 R_L): \text{Bridge Mode} \quad (3)$$

$$P_{\text{DMAX-ROUT}} = 4(V_{\text{DD}})^2 / (2\pi^2 R_L): \text{Bridge Mode} \quad (4)$$

The maximum internal power dissipation of the LM4855 occurs when all 3 amplifiers pairs are simultaneously on; and is given by Equation (5).

$$P_{\text{DMAX-TOTAL}} = P_{\text{DMAX-SPKROUT}} + P_{\text{DMAX-LOUT}} + P_{\text{DMAX-ROUT}} \quad (5)$$

The maximum power dissipation point given by Equation (5) must not exceed the power dissipation given by Equation (6):

$$P_{\text{DMAX}'} = (T_{\text{JMAX}} - T_A) / \theta_{\text{JA}} \quad (6)$$

The LM4855's $T_{\text{JMAX}} = 150^\circ\text{C}$. In the YZR package, the LM4855's θ_{JA} is 48°C/W . In the NHW package soldered to a DAP pad that expands to a copper area of 2.5in^2 on a PCB, the LM4855's θ_{JA} is 42°C/W . At any given ambient temperature T_A , use Equation (6) to find the maximum internal power dissipation supported by the IC packaging. Rearranging Equation (6) and substituting $P_{\text{DMAX-TOTAL}}$ for $P_{\text{DMAX}'}$ results in Equation (7). This equation gives the maximum ambient temperature that still allows maximum stereo power dissipation without violating the LM4855's maximum junction temperature.

$$T_A = T_{\text{JMAX}} - P_{\text{DMAX-TOTAL}} \theta_{\text{JA}} \quad (7)$$

For a typical application with a 5V power supply and an 8Ω load, the maximum ambient temperature that allows maximum stereo power dissipation without exceeding the maximum junction temperature is approximately 104°C for the YZR package.

$$T_{\text{JMAX}} = P_{\text{DMAX-TOTAL}} \theta_{\text{JA}} + T_A \quad (8)$$

Equation (8) gives the maximum junction temperature T_{JMAX} . If the result violates the LM4855's 150°C , reduce the maximum junction temperature by reducing the power supply voltage or increasing the load resistance. Further allowance should be made for increased ambient temperatures.

The above examples assume that a device is a surface mount part operating around the maximum power dissipation point. Since internal power dissipation is a function of output power, higher ambient temperatures are allowed as output power or duty cycle decreases. If the result of Equation (5) is greater than that of Equation (6), then decrease the supply voltage, increase the load impedance, or reduce the ambient temperature. If these measures are insufficient, a heat sink can be added to reduce θ_{JA} . The heat sink can be created using additional

copper area around the package, with connections to the ground pin(s), supply pin and amplifier output pins. External, solder attached SMT heatsinks such as the Thermalloy 7106D can also improve power dissipation. When adding a heat sink, the θ_{JA} is the sum of θ_{JC} , θ_{CS} , and θ_{SA} . (θ_{JC} is the junction-to-case thermal impedance, θ_{CS} is the case-to-sink thermal impedance, and θ_{SA} is the sink-to-ambient thermal impedance.) Refer to the [Typical Performance Characteristics](#) curves for power dissipation information at lower output power levels.

POWER SUPPLY BYPASSING

As with any power amplifier, proper supply bypassing is critical for low noise performance and high power supply rejection. Applications that employ a 5V regulator typically use a 10 μ F in parallel with a 0.1 μ F filter capacitors to stabilize the regulator's output, reduce noise on the supply line, and improve the supply's transient response. However, their presence does not eliminate the need for a local 1.0 μ F tantalum bypass capacitance connected between the LM4855's supply pins and ground. Keep the length of leads and traces that connect capacitors between the LM4855's power supply pin and ground as short as possible. Connecting a 1 μ F capacitor, C_B , between the BYPASS pin and ground improves the internal bias voltage's stability and improves the amplifier's PSRR. The PSRR improvements increase as the bypass pin capacitor value increases. Too large, however, increases turn-on time and can compromise the amplifier's click and pop performance. The selection of bypass capacitor values, especially C_B , depends on desired PSRR requirements, click and pop performance (as explained in the section [Selecting External Components](#)) system cost, and size constraints.

SELECTING EXTERNAL COMPONENTS

Input Capacitor Value Selection

Amplifying the lowest audio frequencies requires high value input coupling capacitor (C_i in [Figure 1](#)). A high value capacitor can be expensive and may compromise space efficiency in portable designs. In many cases, however, the speakers used in portable systems, whether internal or external, have little ability to reproduce signals below 150Hz. Applications using speakers with this limited frequency response reap little improvement by using large input capacitor.

The internal input resistor (R_i) and the input capacitor (C_i) produce a high pass filter cutoff frequency that is found using Equation (9).

$$f_c = 1 / (2\pi R_i C_i) \quad (9)$$

As an example when using a speaker with a low frequency limit of 150Hz, C_i , using Equation (9) is 0.063 μ F. The 0.22 μ F C_i shown in [Figure 1](#) allows the LM4855 to drive high efficiency, full range speaker whose response extends below 40Hz.

Bypass Capacitor Value Selection

Besides minimizing the input capacitor size, careful consideration should be paid to value of C_B , the capacitor connected to the BYPASS pin. Since C_B determines how fast the LM4855 settles to quiescent operation, its value is critical when minimizing turn-on pops. The slower the LM4855's outputs ramp to their quiescent DC voltage (nominally $V_{DD}/2$), the smaller the turn-on pop. Choosing C_B equal to $1.0\mu\text{F}$ along with a small value of C_i (in the range of $0.1\mu\text{F}$ to $0.39\mu\text{F}$), produces a click-less and pop-less shutdown function. As discussed above, choosing C_i no larger than necessary for the desired bandwidth helps minimize clicks and pops. C_B 's value should be in the range of 5 times to 7 times the value of C_i . This ensures that output transients are eliminated when power is first applied or the LM4855 resumes operation after shutdown.

Demonstration Board Layout

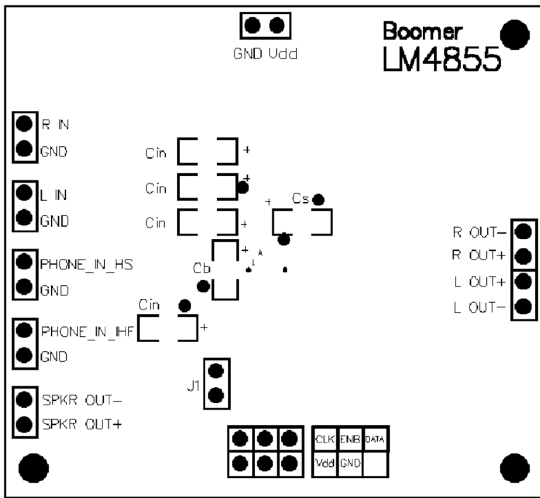

Figure 38. Recommended YZR PC Board Layout: Top Silkscreen

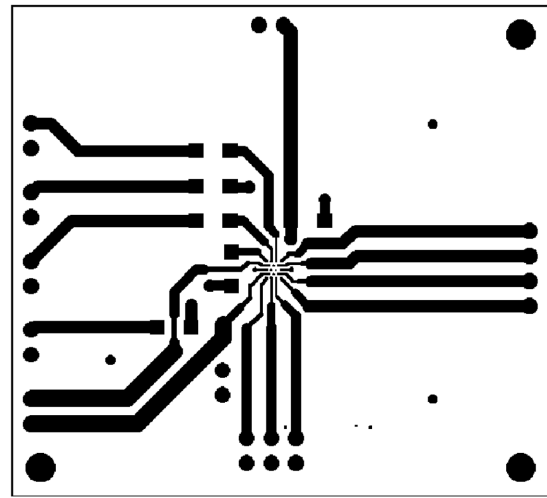

Figure 39. Recommended YZR PC Board Layout: Top Layer

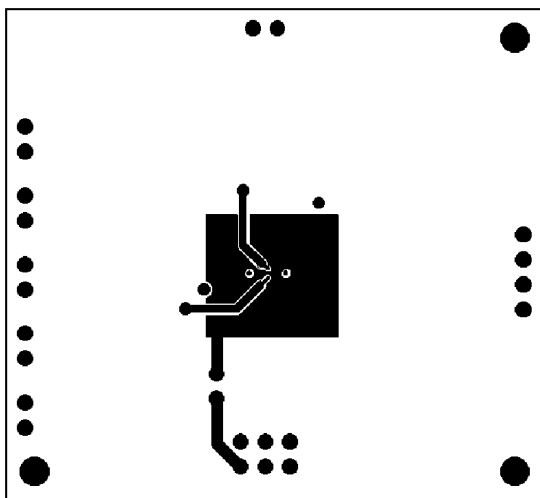

Figure 40. Recommended YZR PC Board Layout: Middle Layer

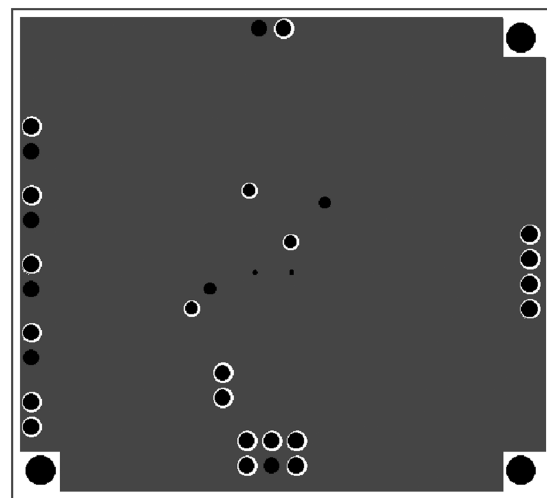

Figure 41. Recommended YZR PC Board Layout: Bottom Layer

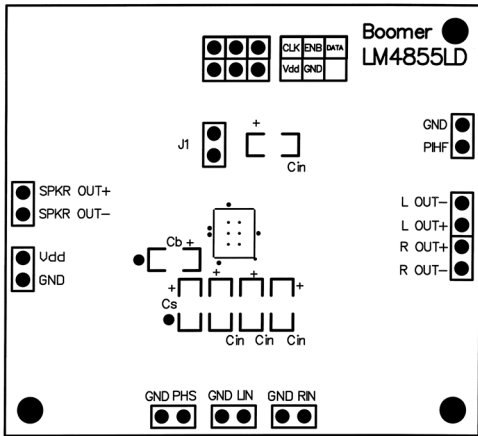

Figure 42. Recommended NHW PC Board Layout: Top Silkscreen Layer

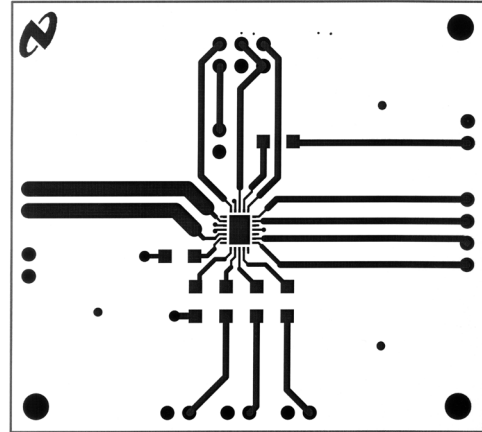

Figure 43. Recommended NHW PC Board Layout: Top Layer

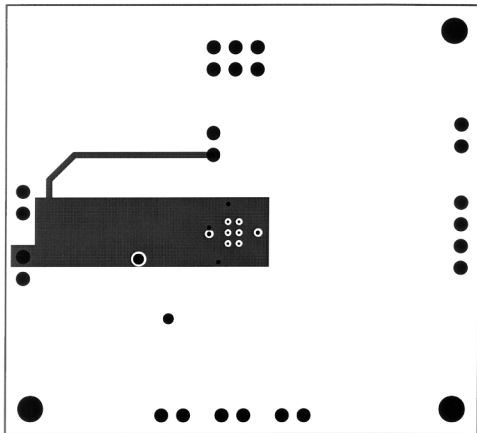

Figure 44. Recommended NHW PC Board Layout: Inner Layer 1

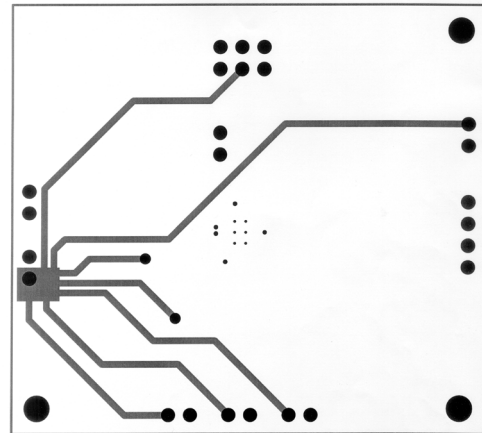

Figure 45. Recommended NHW PC Board Layout: Inner Layer 2

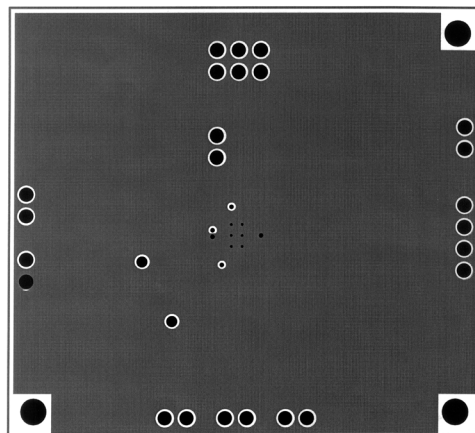

Figure 46. Recommended NHW PC Board Layout: Bottom Layer

REVISION HISTORY

Changes from Revision B (May 2013) to Revision C	Page
• Changed layout of National Data Sheet to TI format	21

PACKAGING INFORMATION

Orderable Device	Status (1)	Package Type	Package Drawing	Pins	Package Qty	Eco Plan (2)	Lead finish/ Ball material (6)	MSL Peak Temp (3)	Op Temp (°C)	Device Marking (4/5)	Samples
LM4855LQ/NOPB	ACTIVE	WQFN	NHW	24	1000	RoHS & Green	SN	Level-3-260C-168 HR	-40 to 85	L4855LQ	Samples

(1) The marketing status values are defined as follows:

ACTIVE: Product device recommended for new designs.

LIFEBUY: TI has announced that the device will be discontinued, and a lifetime-buy period is in effect.

NRND: Not recommended for new designs. Device is in production to support existing customers, but TI does not recommend using this part in a new design.

PREVIEW: Device has been announced but is not in production. Samples may or may not be available.

OBSOLETE: TI has discontinued the production of the device.

(2) **RoHS:** TI defines "RoHS" to mean semiconductor products that are compliant with the current EU RoHS requirements for all 10 RoHS substances, including the requirement that RoHS substance do not exceed 0.1% by weight in homogeneous materials. Where designed to be soldered at high temperatures, "RoHS" products are suitable for use in specified lead-free processes. TI may reference these types of products as "Pb-Free".

RoHS Exempt: TI defines "RoHS Exempt" to mean products that contain lead but are compliant with EU RoHS pursuant to a specific EU RoHS exemption.

Green: TI defines "Green" to mean the content of Chlorine (Cl) and Bromine (Br) based flame retardants meet JS709B low halogen requirements of <=1000ppm threshold. Antimony trioxide based flame retardants must also meet the <=1000ppm threshold requirement.

(3) MSL, Peak Temp. - The Moisture Sensitivity Level rating according to the JEDEC industry standard classifications, and peak solder temperature.

(4) There may be additional marking, which relates to the logo, the lot trace code information, or the environmental category on the device.

(5) Multiple Device Markings will be inside parentheses. Only one Device Marking contained in parentheses and separated by a "-" will appear on a device. If a line is indented then it is a continuation of the previous line and the two combined represent the entire Device Marking for that device.

(6) Lead finish/Ball material - Orderable Devices may have multiple material finish options. Finish options are separated by a vertical ruled line. Lead finish/Ball material values may wrap to two lines if the finish value exceeds the maximum column width.

Important Information and Disclaimer:The information provided on this page represents TI's knowledge and belief as of the date that it is provided. TI bases its knowledge and belief on information provided by third parties, and makes no representation or warranty as to the accuracy of such information. Efforts are underway to better integrate information from third parties. TI has taken and continues to take reasonable steps to provide representative and accurate information but may not have conducted destructive testing or chemical analysis on incoming materials and chemicals. TI and TI suppliers consider certain information to be proprietary, and thus CAS numbers and other limited information may not be available for release.

In no event shall TI's liability arising out of such information exceed the total purchase price of the TI part(s) at issue in this document sold by TI to Customer on an annual basis.

TAPE AND REEL INFORMATION

QUADRANT ASSIGNMENTS FOR PIN 1 ORIENTATION IN TAPE

*All dimensions are nominal

Device	Package Type	Package Drawing	Pins	SPQ	Reel Diameter (mm)	Reel Width W1 (mm)	A0 (mm)	B0 (mm)	K0 (mm)	P1 (mm)	W (mm)	Pin1 Quadrant
LM4855LQ/NOPB	WQFN	NHW	24	1000	178.0	12.4	4.3	5.3	1.3	8.0	12.0	Q1

TAPE AND REEL BOX DIMENSIONS



*All dimensions are nominal

Device	Package Type	Package Drawing	Pins	SPQ	Length (mm)	Width (mm)	Height (mm)
LM4855LQ/NOPB	WQFN	NHW	24	1000	208.0	191.0	35.0

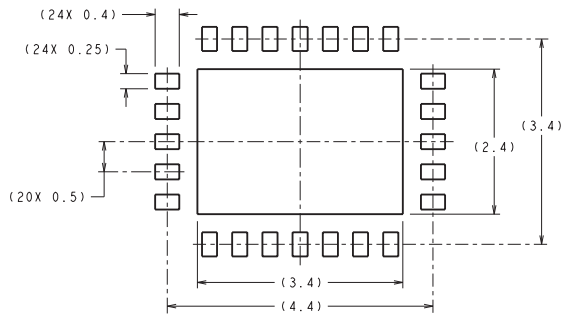
NHW0024B

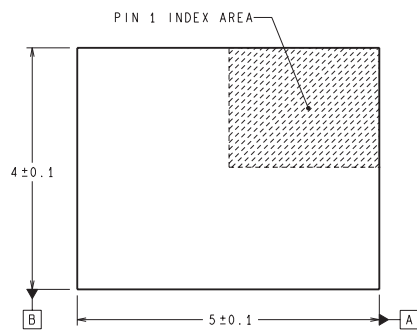

RECOMMENDED LAND PATTERN
1:1 RATIO WITH PKG SOLDER PADS



DIMENSIONS ARE IN MILLIMETERS
DIMENSIONS IN () FOR REFERENCE ONLY

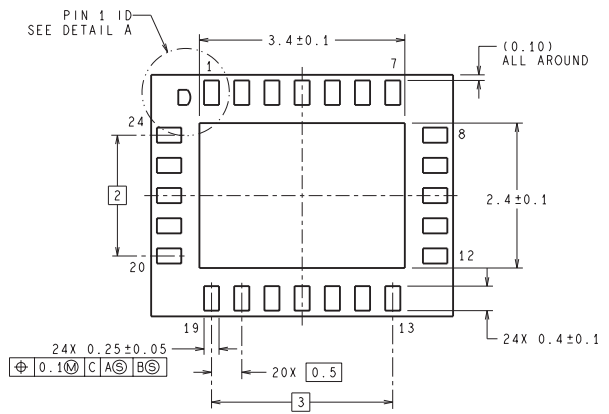
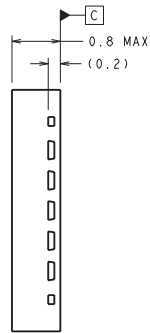
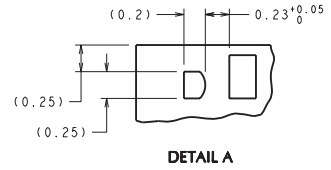

LQA24A (Rev B)

IMPORTANT NOTICE AND DISCLAIMER

TI PROVIDES TECHNICAL AND RELIABILITY DATA (INCLUDING DATA SHEETS), DESIGN RESOURCES (INCLUDING REFERENCE DESIGNS), APPLICATION OR OTHER DESIGN ADVICE, WEB TOOLS, SAFETY INFORMATION, AND OTHER RESOURCES "AS IS" AND WITH ALL FAULTS, AND DISCLAIMS ALL WARRANTIES, EXPRESS AND IMPLIED, INCLUDING WITHOUT LIMITATION ANY IMPLIED WARRANTIES OF MERCHANTABILITY, FITNESS FOR A PARTICULAR PURPOSE OR NON-INFRINGEMENT OF THIRD PARTY INTELLECTUAL PROPERTY RIGHTS.

These resources are intended for skilled developers designing with TI products. You are solely responsible for (1) selecting the appropriate TI products for your application, (2) designing, validating and testing your application, and (3) ensuring your application meets applicable standards, and any other safety, security, regulatory or other requirements.

These resources are subject to change without notice. TI grants you permission to use these resources only for development of an application that uses the TI products described in the resource. Other reproduction and display of these resources is prohibited. No license is granted to any other TI intellectual property right or to any third party intellectual property right. TI disclaims responsibility for, and you will fully indemnify TI and its representatives against, any claims, damages, costs, losses, and liabilities arising out of your use of these resources.

TI's products are provided subject to [TI's Terms of Sale](#) or other applicable terms available either on ti.com or provided in conjunction with such TI products. TI's provision of these resources does not expand or otherwise alter TI's applicable warranties or warranty disclaimers for TI products.

TI objects to and rejects any additional or different terms you may have proposed.

Mailing Address: Texas Instruments, Post Office Box 655303, Dallas, Texas 75265
Copyright © 2021, Texas Instruments Incorporated