

PLEASE CHECK WWW.MOLEX.COM FOR LATEST PART INFORMATION

Part Number: [0398900304](#)
Status: **Active**
Overview: [Eurostyle Terminal Blocks](#)
Description: 5.00mm Pitch Beau Eurostyle Low Profile, Single Level Modular Terminal Block, 4 Circuits

Documents:

3D Model	3D Model (PDF)
Drawing (PDF)	RoHS Certificate of Compliance (PDF)

Agency Certification

UL E48521

General

Product Family	Terminal Blocks
Series	39890
Application	N/A
Component Type	One Piece
Overview	Eurostyle Terminal Blocks
Product Name	Eurostyle Fixed Mount
Type	Euro Block
UPC	756054873373

Physical

Circuits (Loaded)	4
Circuits (maximum)	4
Entry Angle	Horizontal
Flammability	94V-0
Lock to Mating Part	None
Net Weight	3.560/g
Number of Rows	1
Orientation	Vertical
PC Tail Length	3.51mm
PCB Retention	None
PCB Thickness - Recommended	2.40mm
Panel Mount	No
Pitch - Mating Interface	5.00mm
Pitch - Termination Interface	5.00mm
Polarized to Mating Part	No
Shrouded	Fully
Stackable	Yes
Surface Mount Compatible (SMC)	No
Temperature Range - Operating	105°C
Wire Size AWG	16, 18, 20, 22, 24, 26, 28, 30
Wire Size mm ²	0.20-1.50

Electrical

Current - Maximum per Contact	13.5A
Voltage - Maximum	300V

Material Info

Engineering Number MX-MSB04001-0N

Reference - Drawing Numbers

Sales Drawing SD-39890-003-001

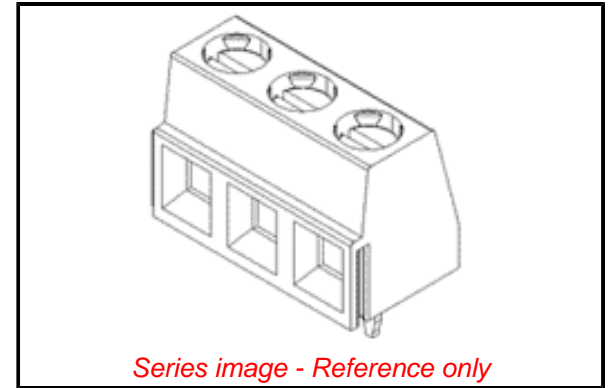

EU ELV

Not Relevant

EU RoHS

Compliant with Exemption 6(c)

REACH SVHC

Contained Per - D(2021)4569-DC (8 July 2021)

Lead

Halogen-Free

Status

Low-Halogen

For more information, please visit [Contact US](#)

China ROHS

50 Image

ELV

Not Relevant

RoHS Phthalates

Not Contained

Search Parts in this Series

[39890 Series](#)

This document was generated on 08/26/2021

PLEASE CHECK WWW.MOLEX.COM FOR LATEST PART INFORMATION