

Contact Detail:
541-Wire Wrap .026x.024(0.66x0.61) - Tail
LG=.620(15.75)

THIS IS A C.A.D. GENERATED DRAWING
 DO NOT MAKE MANUAL REVISIONS TO MASTER



ISSUE NUMBER

ORIGINAL

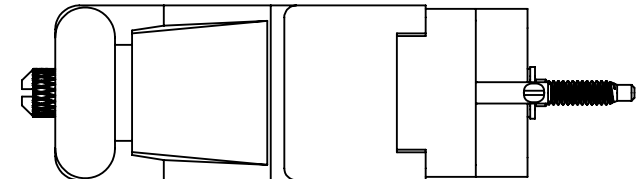
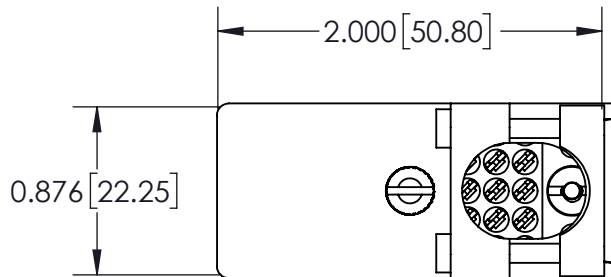

Features

- UL Recognized
- .150 (3.81) Contact Spacing x .130 (3.30) or .150 (3.81) Row Spacing with Staggered Grid
- Plug and Receptacle in 14 or 36 Contact Sizes
- Edacon Hermaphroditic Contact Mating Design
- Contact Termination Options Include: Crimp, P.C. Tail, Wire Hole and Wire Wrap
- Mating and Unmating Simplified with use of Actuating Screws
- Optional Covers with Side or Top Entry Cable Clamp in Plastic or Metal Material Available for All Connector Sizes
- Versatile Metal Cover Design Permits Assembly and Disassembly after Cabling is Complete plus Cable Entry Style Flexibility
- Actuating Screws, Locknuts, Polarizing Hardware, Covers and Contacts Suitable for either Plug or Receptacle
- Polarizing Hardware Adjustable for 288 Mating Combinations
- Tools Available for Contact Installation, Removal and Crimping and Polarizing Changes

Specifications

- Insulator Material: Polycarbonate, Colour: Grey
- Contact Material: Phosphor Bronze Alloy CA-510
- Contact Plating: Gold over Nickel for Entire Contact
- Cover Material: Polycarbonate, Colour: Green, or Die-Cast Zinc, Finished with Grey Enamel Paint
- Current Rating: 8.5 Amperes
- Contact Resistance: 10 Milliohms Maximum
- Dielectric Withstanding Voltage: 2000 V AC rms at Sea Level
- Insulation Resistance: 5000 Megohms Minimum
- Operating Temperature: -65 to +125 Degrees C
- Insertion and Withdrawal Force: 2 to 16 oz (0.56 to 4.45 N) per Contact Position

See Accompanying Pages for:
 - PC Tail Layout
 - Cutout Panel Details
 - Cover Details

519 Assembly		ACAD REFERENCE NO. 519 Assembly	
Part Number: 519-036-541-311		DRAWN: J.LEE	DATE: JUNE 18, 2009
		CHECKED:	DATE:
		SCALE: 1:1	SHEET 1 OF 4
		DRAWING NUMBER	ISSUE
		519 Assembly	1



EDAC INC
 TORONTO, ONTARIO
 CANADA

YOUR CONNECTION TO QUALITY & SERVICE

THESE DRAWINGS AND SPECIFICATIONS ARE THE PROPERTY OF EDAC INC. AND SHALL NOT BE REPRODUCED, OR COPIED OR USED AS THE BASIS FOR THE MANUFACTURE OR SALE OF APPARATUS WITHOUT WRITTEN PERMISSION.

THIS IS A C.A.D. GENERATED DRAWING
DO NOT MAKE MANUAL REVISIONS TO MASTER.



ISSUE NUMBER

ORIGINAL

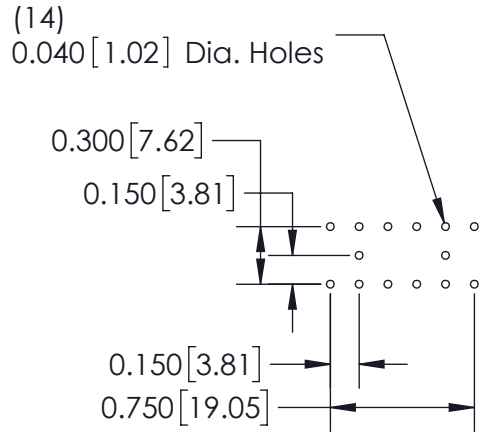

14 Pin
P.C. Tail Layout

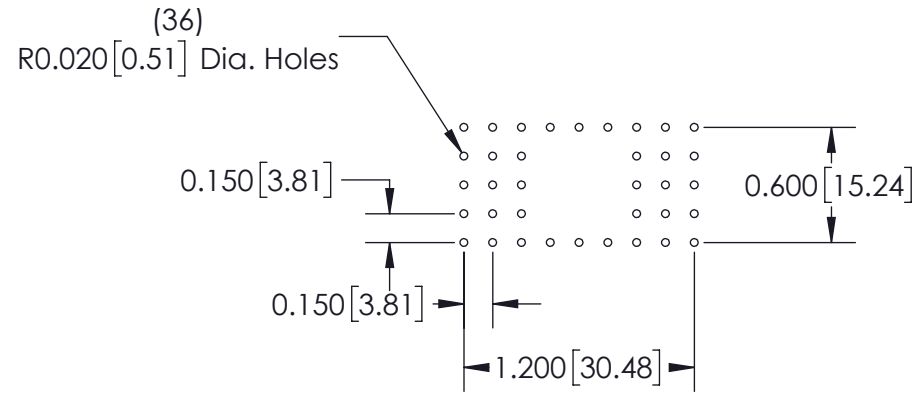

36 Pin
P.C. Tail Layout

519 Assembly P.C. Tail Layout Details		ACAD REFERENCE NO. 519 Assembly	
		DRAWN: J.LEE	DATE: JUNE 18, 2009
 EDAC INC TORONTO, ONTARIO CANADA YOUR CONNECTION TO QUALITY & SERVICE		CHECKED:	DATE:
		SCALE: 1:1	SHEET 2 OF 4
		DRAWING NUMBER 519 Assembly	ISSUE 1

THESE DRAWINGS AND SPECIFICATIONS ARE THE PROPERTY OF EDAC INC. AND SHALL NOT BE REPRODUCED, OR COPIED OR USED AS THE BASIS FOR THE MANUFACTURE OR SALE OF APPARATUS WITHOUT WRITTEN PERMISSION.

THIS IS A C.A.D. GENERATED DRAWING
DO NOT MAKE MANUAL REVISIONS TO MASTER.



ISSUE NUMBER

ORIGINAL

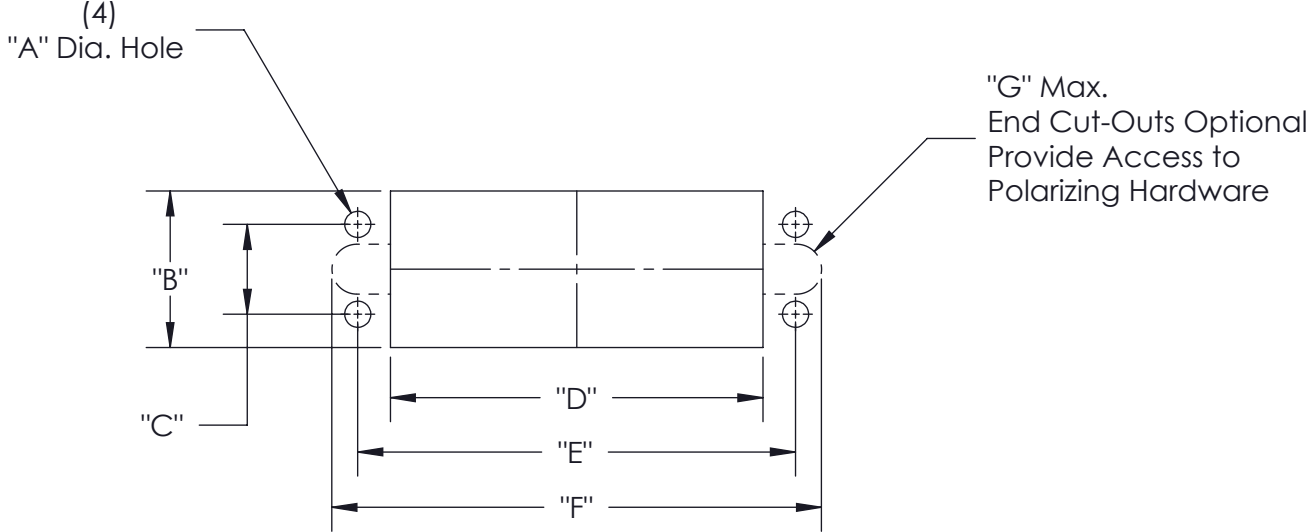

	Dimension A	Dimension B	Dimension C	Dimension D	Dimension E	Dimension F	Dimension G
14 Pin	0.104 [2.64]	0.640 [16.26]	0.410 [10.41]	0.960 [24.38]	1.126 [28.60]	1.32 [33.53]	R0.130 [R3.30]
36 Pin	0.136 [3.45]	0.816 [20.73]	0.468 [11.89]	1.420 [36.07]	1.688 [42.88]	1.96 [49.78]	R0.130 [R3.30]

519 Assembly Cut-Out Panel Detail		ACAD REFERENCE NO. 519 Assembly	
		DRAWN: J.LEE	DATE: JUNE 18, 2009
 EDAC INC TORONTO, ONTARIO CANADA YOUR CONNECTION TO QUALITY & SERVICE		CHECKED:	DATE:
		SCALE:	SHEET 3 OF 4
		DRAWING NUMBER 519 Assembly	ISSUE 1

THESE DRAWINGS AND SPECIFICATIONS ARE THE PROPERTY OF EDAC INC. AND SHALL NOT BE REPRODUCED, OR COPIED OR USED AS THE BASIS FOR THE MANUFACTURE OR SALE OF APPARATUS WITHOUT WRITTEN PERMISSION.

THIS IS A C.A.D. GENERATED DRAWING
DO NOT MAKE MANUAL REVISIONS TO MASTER.



ISSUE NUMBER
ORIGINAL



Top Entry



Side Entry



Standard Clamp



Large Clamp

Cover for Connector	Cover Material	Clamp Size	"A"	"B"	"C"	"D"	"E"	"F"	"G"
14 Pin	Plastic	Standard	1.605 (40.77)	1.325 (33.66)	0.906 (23.01)	1.190 (30.23)	0.715 (18.16)	0.450 (11.43)	0.450 (11.43)
14 Pin	Metal	Standard	1.539 (39.09)	1.325 (33.66)	0.906 (23.01)	1.120 (28.45)	0.686 (17.42)	0.446 (11.33)	0.490 (12.45)
36 Pin	Plastic	Standard	2.460 (62.48)	2.010 (51.05)	1.530 (38.86)	1.985 (50.42)	0.910 (23.11)	0.650 (16.51)	0.500 (12.70)
36 Pin	Plastic	Large	2.460 (62.48)	2.010 (51.05)	1.530 (38.86)	1.985 (50.42)	1.110 (28.19)	0.650 (16.51)	0.608 (15.44)
36 Pin	Metal	Standard	2.206 (56.03)	2.006 (50.95)	1.566 (39.78)	1.766 (44.86)	0.875 (22.23)	0.720 (18.29)	0.575 (14.61)

519 Assembly Cut-Out Panel Detail		ACAD REFERENCE NO. 519 Assembly	
		DRAWN: J.LEE	DATE: JUNE 18, 2009
 EDAC INC TORONTO, ONTARIO CANADA YOUR CONNECTION TO QUALITY & SERVICE		CHECKED:	DATE:
		SCALE:	SHEET 4 OF 4
THESE DRAWINGS AND SPECIFICATIONS ARE THE PROPERTY OF EDAC INC. AND SHALL NOT BE REPRODUCED, OR COPIED OR USED AS THE BASIS FOR THE MANUFACTURE OR SALE OF APPARATUS WITHOUT WRITTEN PERMISSION.		DRAWING NUMBER	ISSUE
		519 Assembly	1