



ATX LED Inc  
1108 Lavaca St Ste 110, #489  
Austin Tx, 78701  
512 377 6052  
<http://atx-led.com>

AL-WS-DR2 44-52vdc

Decorator style Switch/Driver

Dual Constant Current

56 watt 3-Way DALI CCT

12 volt Fan direct drive

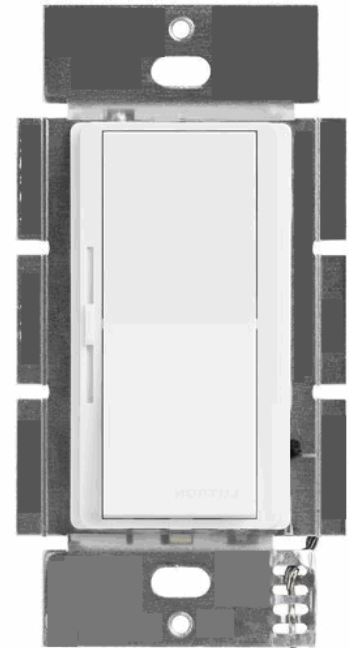

### Product Description - AL-WS-DR2 wall switch

This switch operates just like any standard residential light switch – however it takes 24-54v DC instead of 120VAC, and directly drives up to 56 watts of LED bulbs. This Decorator style switch in a standard residential style outline fits into any home, looks like any switch yet meets NEC article 411 for Low Voltage lighting.

It supports fixed color temperature or tunable white LED fixtures for time of day light controls. With tunable white, it supports dim to warm.

Stand alone it operates as a simple switch for 2 strings of LED's. Jumper selections for 2 channels with 300, 360, 660 or 720 mA for up to 30 watts per channel. For example, 10 x 6 Watt LEDs can connected, 4 in series to each of the 2 outputs on this switch / dimmer device. Use AWG 16 or 18 to bring 48v ( or 24 to 54 volts ) from a central power supply over to the switches, then use AWG 20 to connect to your LEDs – no crimping tools are required to wire this device.

For 3-way operation – a simple 2 wire link with AWG24 or better allows 2, 3, or an unlimited numbers of switches to control one set of LED's. Any single pole switch found at Home Depot can be used to add a 3-Way remote switch, or the AL-WS-M momentary switch can be used for unlimited 3-Way connections.

A proven mechanical switch and brightness slider leverages mass production of Decorator switches, now for low voltage applications – a casual user requires no training, no App to use this switch. Perfect, flicker free dimming from off to 0.1% to 100%. No network setup is required.

To enable Home / Business automation – the AL-WS-DR2 includes a DALI opto isolated serial bidirectional port for remote and voice control. Use the AL-DALI-Pi Hub to connect to Alexa or Google home voice control. The DALI protocol is supported, with automatic addressing. Use low cost wire in uncomplicated topology to implement remote management. Power and DALI have in and out connectors to avoid wire nuts.

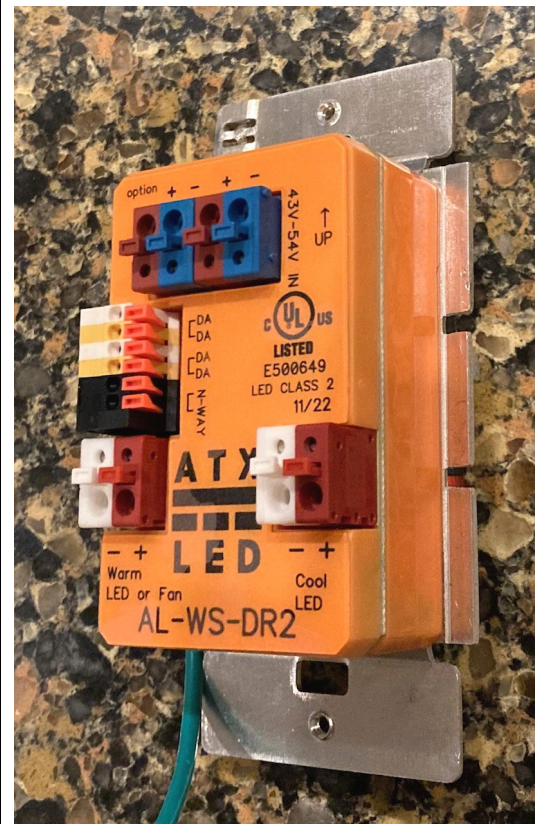

## Specifications

Power source and Pass Thru	Spring loaded connectors ( 2 pairs ) for AWG 16-20 wire type KF246
LED constant current output	660 per channel
Dimming range	Spring loaded connectors ( 2 pairs ) type KF246
Input voltage range	100 uA to 660 mA, 3000 steps
Standby power consumption	44v to 52 volts ( power for LEDs)
Conversion efficiency	100 milliwatts
Protection	Over 95%
Operating Temperature	Reverse voltage and static electricity Short Circuit, Overvoltage,
Size	0°C ~ 50°C
Dimming	108H (metal) 70H x 34 D x 42 W mm
FCC and interference	100% to 1% ( V3) or 5% ( v2)
Maximum output voltage	Current control with temperature tracking
Minimum output voltage	All outputs are RF filtered for minimal interference
Strip LED support ( CV Mode)	Input minus 5 volts
Hot Swap	6 volts, self calibrating
User Error tolerant	Autodetect 12v, 24v, 48v CV strips
DALI interface	connect LEDs with power applied without damage
N-Way input	Detects and displays most user errors
LED Timer	2 mA load or less, 24v max
FAN output	3v to any simple contact for 3-Way or Fan control
FAN and LED Timers	Configurable auto off
UL Control	12 volts, 1 amp with speed control
UL Type Action	Configurable Auto On and Auto Off
UL Pollution Degree	Independent Mounted, Operating Lighting Control
UL Impulse Voltage	Type 1 Action
	2
	500v

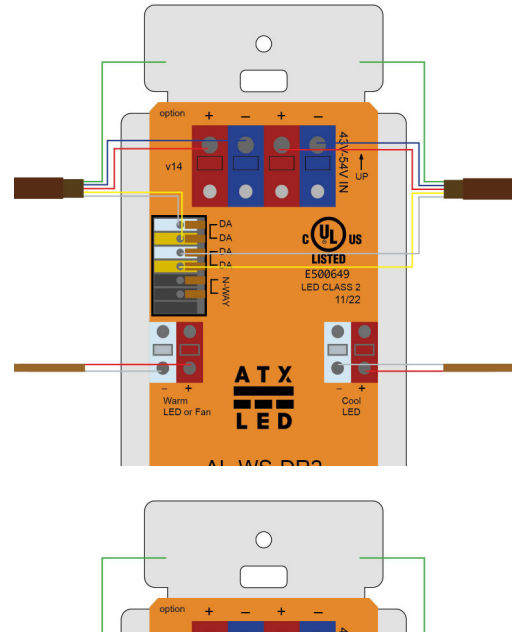

DR2 Connections

## Wiring ATX Switches to the Home Run use 18/5 wire for power and Data

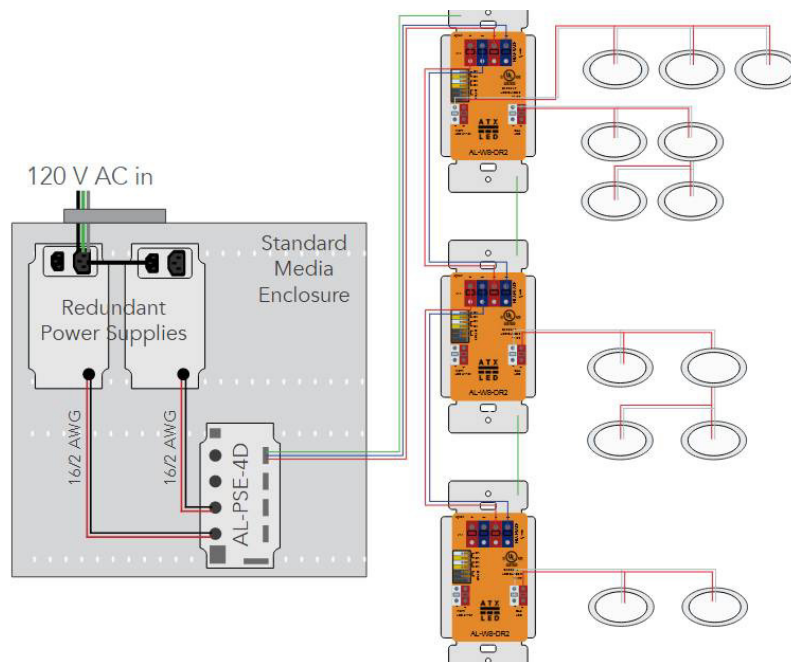

## Wiring the AL-WS-DR2 for up to 8 fixed LEDs

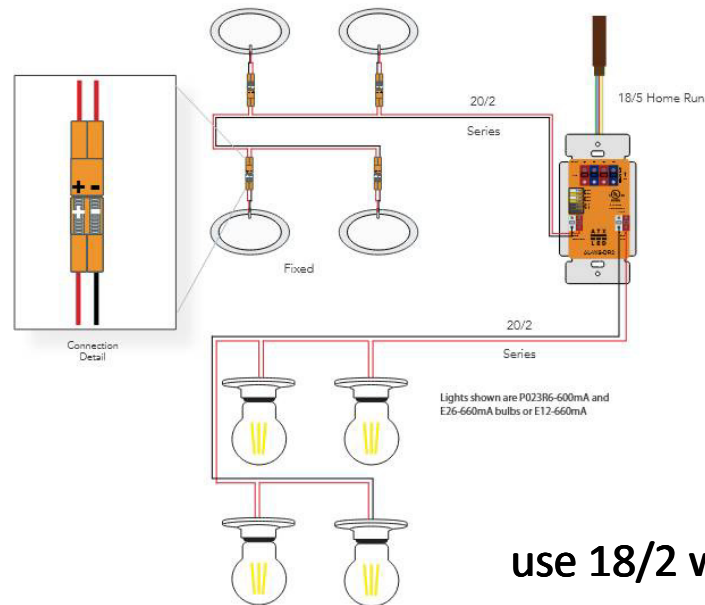

## Wiring the AL-WS-DR2 for 1 to 4 CCT LEDs

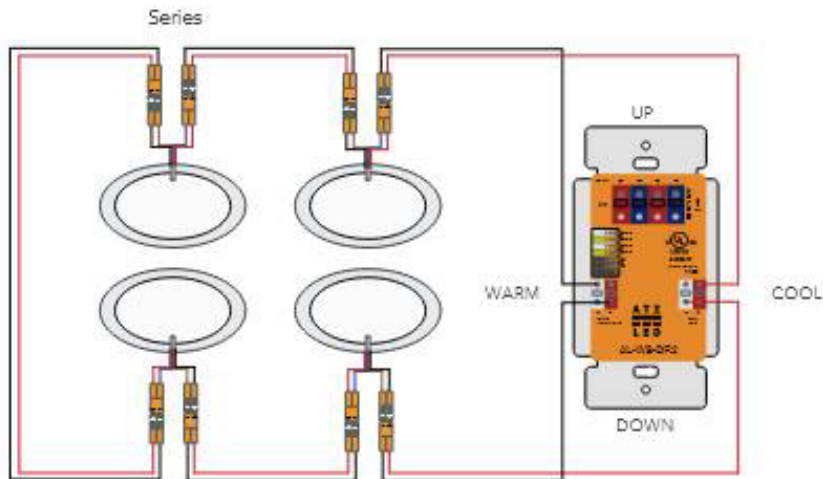

use 18/2 wire in a full loop

## Powering the AL-WS-DR2 the first time

Power the switch via either of the 2 power input connectors, 44 to 54v is recommended. No DALI connection is required. You can pass power thru from one set of power connectors to the other to avoid wire nuts in the box, up to 2 amps. After power up – the first time the switch is operated you will see a flicker while it learns the capability of the attached LED. After that phase – the result is stored in on-board EEprom for flicker free operation.

## Slider Orientation – Left or Right ?

Please install with the slider on the left, therefore no configuration is needed.

If the slider is on the right, configuration is required from the ATX LED Hub to have the slider “up” make the LEDs brighter

If you want the slider on the Right to match the AL-WS-DR1 without setup – please order the Rocker model instead of the momentary version

## Default Operation – stand alone

By default – the AL-WS-DR2 operates stand alone – no controller or DALI connection is master is required. N-Way works. Connect the LED outputs to your LED's. CCT mode will be initiated if the number of LEDs on both sides is the same. Fixed color mode will be initiated if the number of LEDs on both sides does not match. If a 12v Fan is attached, it will be automatically detected and managed – see Fan control notes.

Dimming is via the slider, Color temperature control occurs with the switch pushed moving the slider at the same time. Many advanced features require the ATX LED Hub to set the features – after which the ATX LED Hub can be removed again – it is not needed for operation.

## Installation manual and Videos, FAQ



The screenshot shows the ATX LED website interface. At the top left is the ATX LED logo. The main header reads "Signature Solutions" with a "no flash" icon on the right. Below the header is a navigation menu with links: OUR STORY, SHOP, VIDEO, SMART, SIMPLE, FIXTURES, FANS, HOW TO WIRE, GALLERY, DMX, CONTACT, and FAQ. A "DataSheets" section is highlighted, displaying a data sheet for the "AL-WS-DR2 (v3) Decorator style Switch Driver". The data sheet lists features: Dual Constant Current, Tunable White, 56 watt, 3-Way, DALI, CV and CC autodetect, and 12 volt Fan direct drive. An image of the device is shown next to the text. Below the data sheet, the text reads "Wall Switch Dimmer / Driver for lights and fans".

<https://atxled.com/How2/>

<https://atxled.com/Video/>

<https://atxled.com/pdf/>

<https://atxled.com/FAQ/>

## AL-WS-DR2 Versions

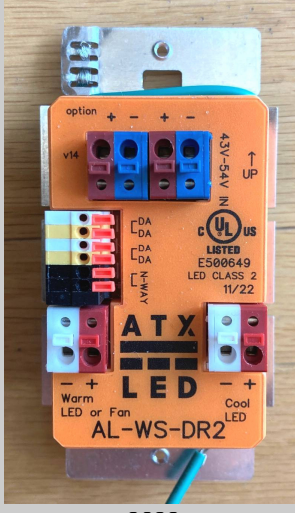
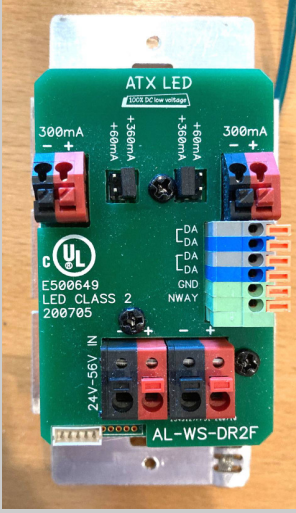
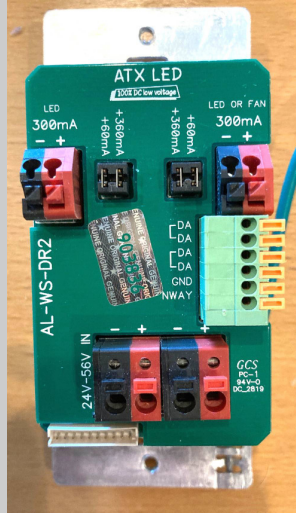
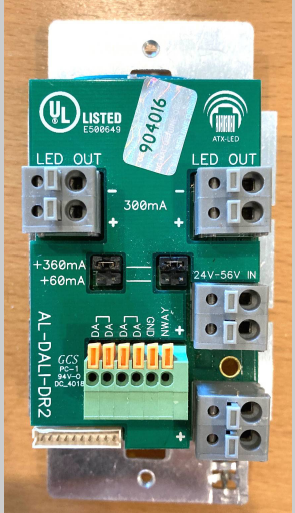
 <p>2023</p>	 <p>2020</p>	 <p>2019</p>	 <p>2018</p>
<p>Tunable CCT low dim Fan Diagnostics+Topology</p>	<p>Tunable CCT low dim Fan Diagnostics</p>	<p>Fixed CCT low dim</p>	<p>Fixed CCT</p>

## Related Products

Model	LED mode	Fan	DA Bus	N-Way
AL-WS-DR2	Auto Detect CCT	Exhaust	Full Operation	Full
AL-WS-DR2C	CCT Selector	Exhaust	Peer - Peer	Limited
AL-WS-DR2W	CCT Selector	Exhaust	No – WiFi only	Yes
AL-WS-DR1	Fixed	no	No	Rocker
AL-WS-8B	Remote	Remote	Full	acts as 3-Way
AL-WS-010v	Remote	Ceiling	Full	acts as 3-Way
AL-WS-DR1D	Fixed	Exhaust, Ceiling	Full	Full

View the <https://atxled.com/How2/> wiring guide before wiring

Wiring example

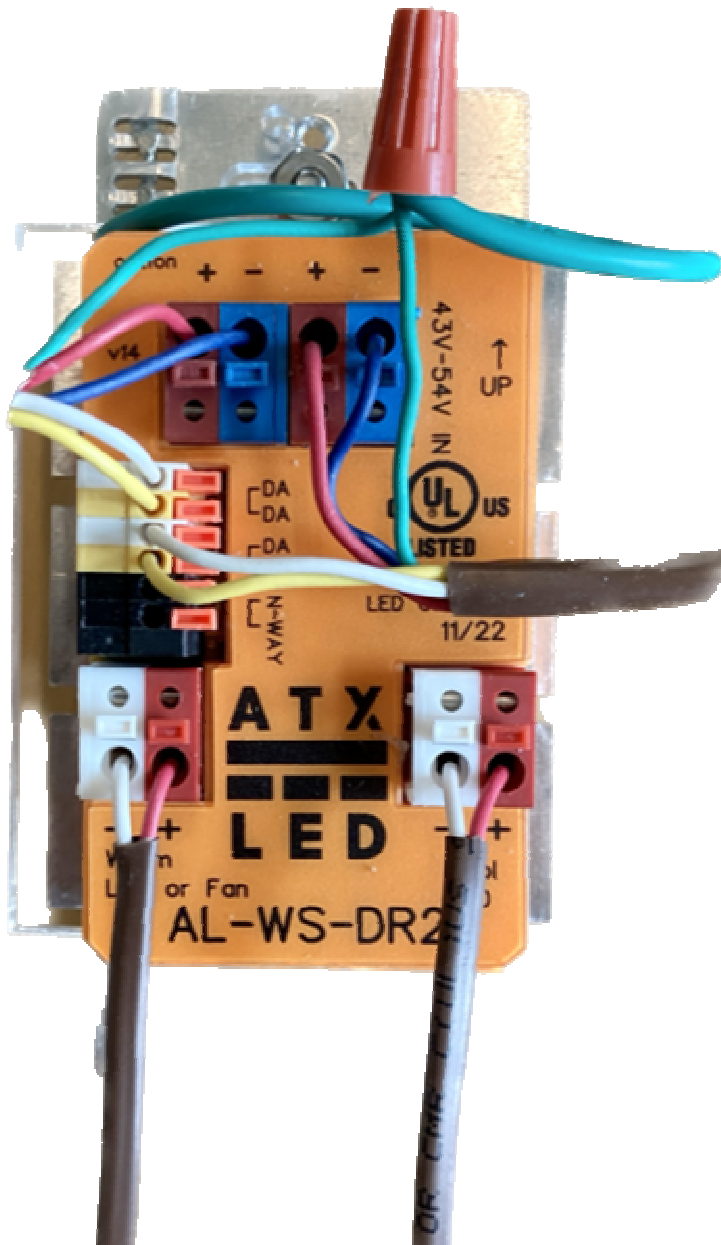

### Basic Connection

8 Fixed LEDs or  
4 CCT with  
6 watts each

Power the switch via the Power input connectors, 51v is recommended. 44-54 volts is the range.

For 5 fixture applications, a 54v supply is required.

Shown here is a brown 18/5 thermostat cable for the power input and pass-thru to the next switch, You can feed thru from the input to the output up to 2 amps total.

The Red/White wires are to the LEDs – fixed wiring shown.

The Yellow and White wires for control (DALI) in and out.

The Green wire is for static protection earth ground

## Light Switch operation – Momentary style

A momentary switch springs back to On when the lever is pressed down, an On/Off does not spring back (On/Off see below)  
When installing a momentary switch type - the slider is on the left, LED outputs on the bottom.

Function	Press	How to trigger
On / Off	½ second	Push the switch down for under ½ second. The light will turn on and off each time you press. See timer mode if enabled.
Fade Override	½ second	If the light is in fading off slowly – the fade can be ended by pressing the switch a 2 <sup>nd</sup> time. For example – if the fade off time is 90 seconds, and you wish the LED to turn off immediately – press the momentary switch twice – the light will turn off without delay.
Adjust Color Temperature	hold	Press and hold the switch, the Slider now controls the color temperature – release the switch when the color you like is reached. 1 second after release, you can change the brightness
Reset to defaults: Recalibrate the LED currents Set switches to On/Off style	60	Press and hold the switch for 60 seconds. The switch will enter self calibration mode the next time the light is turned on.  The LED operating mode after a reset will be Auto. The N-Way mode will not be changed, and the N-Way switch will be changed from Momentary to Rocker. The short address will not be changed
Restore to Momentary Style	5 times ½ second	Should the light not stay on when the momentary switch is pressed, the device is in Rocker mode. Press the switch 5 times with less than 0.5 seconds each to change to Momentary operation.

## Light Switch operation – On/Off style

A momentary switch springs back to On when the lever is pressed down, an On/Off switch does not spring back When installing a On/Off switch type, the Slider is on the right. This mode requires a DALI master to enable

Function	How to trigger
Exit Momentary Style	Should the not act like a simple On/Off switch, then it might be in Momentary style. A Factory reset will fix this.  Factory reset – press switch top in, wait 60 seconds, turn switch off.  The device will return to On/Off style and will recalibrate.
Adjust Color Temperature	If the LED is off – move the slider. The light will turn on and you can adjust the color temperature. After adjusting the color temperature – turn the switch ON, and you can adjust the brightness. Turn the switch off and the color temperature and brightness will be saved.  Color mode will automatically end after 10 seconds.
Reset to defaults: waiting to calibrate switches are On/Off type	Set the dim to low dim. Turn the switch on for 2 seconds. Now off and on 8 times, quickly, leaving it on after the last flip. The brightness will change to 50%, then go off  The switch will enter self calibration mode and the lights will flash.

## Light 3-Way Switch Functions – Momentary style

The remote (3-Way) switch can be either momentary or On/Off. If it is the momentary style, then use this table. A momentary switch springs back to On when the lever is pressed down. We recommend the protruding part of the switch be at the bottom, but it is not critical.

The N-Way switch input can use the same DALI address as the main switch – or it can have its own DALI address. See below for 2<sup>nd</sup> DALI address

If you press the momentary switch and the lights do not stay on – you will need to reset the DR2 to 3-Way momentary.

Function	Press	How to trigger
On / Off	½ second	Push the switch down for under ½ second. The light will turn on and off each time you press.
Remote Dimming	2 seconds	Press and hold the switch to dim down, then up. To dim down again, release and press. Do not hold longer than 45 seconds. Upon release the level will be stored and is normally not the same level as the slider on the main switch.
Setting Momentary Style	5 times ½ second	If a AL-WS-DR2 with a momentary switch is operating in On/Off style – then press the rocker 5 times briefly – it will switch to Momentary operation.

## Light 3-Way Switch Functions – On/Off style and contacts

A momentary switch springs back to On when the lever is pressed down, On/Off does not spring back

A On/Off switch can be used with the DR2, as can any other contact – the DR2 will convert to On/Off/Contact operation if the contact is held closed for 45 seconds.

Function	Action	How to trigger
Light On/Off	On or Off	Turn the switch On or Off. Since this is a 3-way, On could be inverted depending on the state of the light.  This can also be a Door contact.
Remote Dimming		Not supported
Change from Momentary to On/Off style	45 seconds	Should the switch get confused and only respond to every 2 <sup>nd</sup> On/Off action – then simply leave On for 45 seconds and the system will correct the error.



## “N-Way” wire input connection – Hardware Options

The N-Way input has several functional options. The default is simple 3-Way. Other options are enabled by DALI commands – see below.

### Many 3-Way Push Buttons in parallel

With the Push Button method – a momentary switch like the AL-WS-M or RH-253 switch can be used. Each momentary action on the N-Way pin will toggle the light on / off. See table above for operation details. Simply wire multiple switches in parallel for unlimited remote switching.

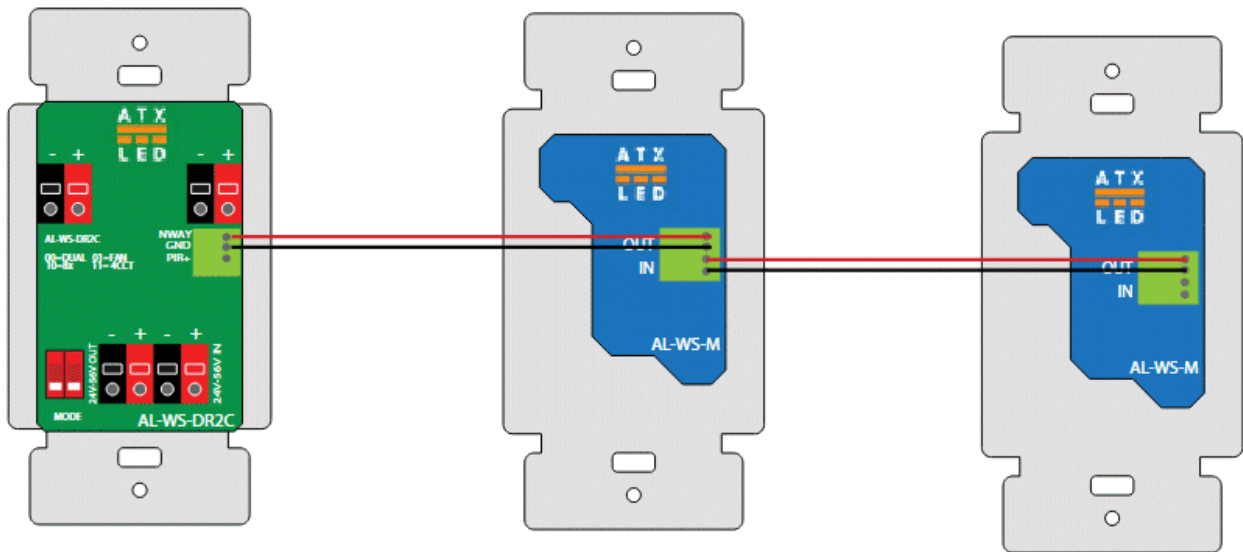

### 3-Way Operation with On/Off rocker

If you prefer a On/Off type of switch - please use a standard simple 2 or 3 way switch connected to the N-Way input. Simply connect a wire (solid CAT-3 or better is recommended, solid awg20 is best) between the N-WAY pins and a remote standard wall switch. If more control switches are needed – see our application note “AN-3Way” at <http://atxled.com/pdfr>. No controller is required; an unlimited number of switches can control one light. 3-Way works in default or DALI modes. The N-Way input has an internal pull-up – so ground to change state. The state of the N-Way input is XOR’d with the physical switch, so Up and Down are no directly indicative of the On/Off light state.

### Remote Dimming

If Push Button momentary mode is used – then the switch connected to the N-Way input can be used to dim the LED. Press and hold to dim the LED down. To Dim up – hold the switch down until it fades to low, and continue to hold so it will brighten back up again. If you reach to high a dim level – then release and press again – the level will decrease. Do not hold the button longer than 45 seconds – since this will change the operation to non-momentary mode. If the DALI bus is configured – DALI dim commands will be transmitted.

## Motion Sensing with smart switches

With an AL-WS-DR2, the motion can be detected and will signal motion to the DALI bus with fw 66 or later. The attached LEDs will be on with motion and automatically go off after a delay. If normal DALI address is turn OFF – motion is not detected.

When the N-Way mode is set to PIR, and the driver mode is not Split – the following changes occur to the N-Way operation: The N-Way input is disconnected from the main On/Off momentary function. If a 2<sup>nd</sup> DALI address is assigned, On/Off/Motion/Dimming packets will be sent via the 2<sup>nd</sup> address.

The main switch will cause DALI On/Off/Dimming packet to be sent on the normal address in all cases.

PIR mode enables these functions

- **Driver mode – ALL Fixed:**  
With the AL-WS-DR2 in ALL Fixed mode, both outputs with up to 10 lights will be controlled by the main switch, by motion, or by the DALI normal address. The Motion sensing LED is only connected to cool. The DALI bus 2<sup>nd</sup> address will be updated with Motion events, or by pressing the N-Way button – see the list of 2<sup>nd</sup> address functions in the AL-WS-DR2 data sheet. The LEDs attached to Warm can be ON when there is no motion – set the System Fail level to be your 24/7 brightness requirement.
- **Driver mode – Split:**  
With the AL-WS-DR2 in Split mode, the Cool LED output is controlled by motion, the main switch, or the DALI normal AL-WS-DR2 short address. The DALI Motion On/Off packets will be sent using command 271, followed by device DALI address + 64 (off) or +128 (on). The Warm LED output will be controlled by the N-Way switch or 2<sup>nd</sup> DALI address without linkage to motion.
- **CCT mode**  
With the AL-WS-DR2 in CCT mode, the LEDs will be controlled by the main switch, by motion, or by the DALI normal address. When no motion is detected, the AL-WS-DR2 maintains 50% of LED Vf on Cool, this powers the sensor, but not the LED, and Warm open circuit with a low current. Upon motion, the DR2 senses a voltage drop on Warm from the open circuit voltage, it then turns current up on both Warm and Cool to full, then off again once the load times out. The LEDs attached to Cool can be ON when there is no motion – set the System Fail level to be your 24/7 brightness requirement.
- **Driver mode – Fan+Light**  
With the AL-WS-DR2 is in Fan+Light mode, a fan was detected on the Warm output. The Cool LED output is motion controlled, main switch controlled, and DALI controlled using the DR2 normal address. The Fan is connected on the Warm output and is in Follow mode – fan follows the Motion light, or the N-Way switch. Requires firmware update

## Alarm Contact – Door switch

A simple Normally Open door alarm switch can be wired to the N-Way input. The current is low so there will be no damage to the contact. Thus – when the door opens – the light will go on. On first installation, the AL-WS-DR2 will require 60 seconds after the door is closed the first time to recognize the contact, after that, the operation mode will be saved. Note – using the N-Way split mode, and by populating the 2<sup>nd</sup> Address – the contact can operate independently of the lights.

# DALI Master Controlled Operation

## Default DALI Operation

By default – the AL-WS-DR2 only responds to DALI broadcast commands – it will not transmit. There is no group or short address assignment. Since the device accepts DALI broadcast commands – any DALI switch or master that sends broadcast commands can connect to this device remotely for on/off/dimming – the LED outputs are controlled by the switch or DALI broadcast packets. In Default mode – no DALI transmissions occur. DALI received commands are treated like 3-way switch controls.

## Full DALI Operation – primary address

For full DALI operation - connect your powered DALI bus to the DA+ and DA- pins (polarity is not significant) of the AL-WS-DR2. The device responds to the provisioning commands from a DALI master. In order for addressable functions to work, a 'short' address [ 0 thru 63] needs to be assigned. This can be done by a DALI Master with configuration features. Once a short address is assigned – the device can be understood to operate as two devices in one.

1) LED driver with DALI control – the LED outputs will have a unique DALI short address after provisioning. The LED driver outputs are connected to LED's and each switch can now be individually controlled by DALI commands from the bus. All DALI 60929-2006 commands are supported. The actual address and group is defined and can be changed by the DALI master. See below.

2) Dimmer / Switch with DALI outputs – after provisioning – the mechanical front switch in this device is placed into either short address or Group mode – see below – flipping the switch, or the 3-way remote switches, or the slider dimming value will cause a DALI command to be sent internally to the LED outputs as well as externally to the DALI bus.

3) A DALI Short Address Reset command will return the device to Broadcast receive mode and disable all On/Off/Dim transmissions.

Use an AL-DALI-PI or other DALI Master or similar provisioning tool to assign short and group addresses.

## DALI Operation – secondary address

A 2<sup>nd</sup> DALI address can be set once the primary address is set by the DALI master. The 2<sup>nd</sup> address can be used for one of the 2 Driver channels, and can be associated with either the N-Way switch or the Main switch. See configuration methods below.

## Swapping Main switch and N-way addresses

The AL-WS-DR2 2<sup>nd</sup> short address feature can be operated from the main switch instead of the N-Way. This allows the internal driver to be a slave of another DALI switch. The Main switch then operates with a 2<sup>nd</sup> Short Address. See below.

# ZWD Management Screen

▼AL-WS-DR2



## Config

Edit name:

Public name:

Visible to cloud:

Groups: 

0	1	2	3	4	5	6	7
8	9	10	11	12	13	14	15

Fade Up:  seconds

Fade Down:  seconds

Min Level:  1

Max Level:  254

Fail Level:  255

Color Temp:  5000

Temp range:

DALI range:

CCT fade time (seconds):

Power On Level:  Off  Last  Manual

Split 2nd address:

Driver Mode:

N-Way Setting:

Slider Position:

Voltage (left):  Auto  V

Voltage (right):  Auto  V

Dim to warm:  %

Color (raw): left:  right:

**Swap left/right**

# LEDs (left):

# LEDs (right):

**Save and recal**

## Status

Channel: 1

Short address: 49

Model ID: AL-WS-DR2F32

UPC: 784099948190

Serial #: ca7d32bd

FW Version: 64

HW Version: 3

Phy Min Level: 1

## DALI Address Assignment - Auto - Grouping

The switch from the factory has no DALI Short address by default. When a DALI master using provisioning assigns a short address to the switch, we have implemented a feature to allow inter switch communication in all DALI ATX-LED devices.

- If the short address is from address 16-63, then the switch will output these state changes using its short address, not a group address: This info is used by the DALI master to know the on/off state of every light, fan etc in the network. It can also be used as a trigger for macros to then create a sequence of light changes.
- If the short address assigned is from 0-15, then the built-in switch will send a Group On/Off/Dim command to the DALI bus each time the local status changes – On, Off, Dim, CCT – from the switch, slider or N-Way. This method allows multiple AL-WS-DR2 to be configured in ‘tandem’ – to all operate as one switch. After assigning each device a short address between 0 and 15, create a tandem virtual 3-way combo. To do this, use the DALI group feature to share multiple groups. For example any ATX switch at short address 1, 2, 3, would each be members of group 1, 2, 3 – allowing perfect 3-Way control – mix AL-WS-010v, AL-WS-DR2 etc with different loads on each. Any AL-WS-DR2 or AL-WS-010v can thus be used as a 3-Way switch with full slider dimming.

DALI commands also are used to determine the 3-Way state. Therefore, a DALI command with the matching Group or Individual as the AL-WS-DR2 address will set the attached lights on or off – and all local switches – physical or virtual – will reflect that change – so that the next flip of any switch will turn the light off or on as intended.

## Tandem Mode – multiple AL-WS-DR2 in unison

With the above Auto Grouping – the AL-WS-DR2 will transmit any change in level or state or CCT, to the group. Therefore, if the group from one AL-WS-DR2 is enabled in other AL-WS-DR2 on the same bus, then those 2 ( or more ) switches will all operate in unison. This allows advanced 3-Way dimming from up to 16 switches for very large rooms, but more typically 2 or 3 in a large living room with multiple egress points. In addition to AL-WS-DR2, AL-WS-010v or AL-WS-8B can all participate in this 3-Way setup. Further, any AL-WS-DR2 on the bus, can have it’s N-Way signal input, programmed to be a member of this group.

Once this Tandem mode is configured, no Hub or Internet is required for this to operate, a simple DALI bus power supply ( 80 mA recommended, 260 mA works also). The ATX LED Hub is a quick way to configure this, but any DALI Master can be used as well.

## Fade up and Fade down

The AL-WS-DR2 supports fade controls – with 3000:1 dimming, precise and seamless fading looks fantastic, and operates autonomously – no hub is required. Brightness fading can be set for 0 to 90 seconds. Up and Down fade times are individually programmed.

Value	0	1	2	3	4	5	6	7	8	9	10	11	12	13	14	15
Fade seconds	0	.7	1	1.4	2	2.8	4	5.6	8	11	16	23	32	45	64	90

## CCT fade

The AL-WS-DR2 supports slow CCT fade – with 3000:1 dimming, precise and seamless fading looks fantastic, and operates autonomously – no hub is required. CCT fade is from 0 to 2550 seconds. This allows smooth color changes at evening for example.

Value	0	1	2	3	4	5	6	7	8	9	10	11	12	13	14	15	255
CCT seconds	0	10	20	30	40	50	60	70	80	90	100	110	120	130	140	150	2550

## Swapping Main and N-way, Slider side

The AL-WS-DR2 2<sup>nd</sup> short address feature can be operated from the main switch instead of the N-Way. This allows the internal driver to be a slave of another DALI switch. The Main switch then operates with a 2<sup>nd</sup> Short Address. Note: The slider will control the internal driver.

Memory 5:30	If Mask result != 0	If Mask result == 0
Mask 0x05	Slider on the Left	Slider on the Right
Mask 0x02	Use Main with 2 <sup>nd</sup> Short Address	Use N-Way with 2 <sup>nd</sup> Short Address

## Software 3-Way Options

DALI commands also are used to determine the 3-Way state. Therefore, an Alexa to DALI interface will set the light on or off – and all local switches – physical or virtual – will reflect that change – so that the next flip of any switch will turn the light off or on as intended.

The Virtual 3-Way method uses 2 or more AL-WS-010v devices with the same short or group address which communicate via the DALI bus. Using the Virtual method just means that each AL-WS-010v will XOR it's physical switch state with the data it receives to its address from the DALI bus. The result allows unlimited numbers of switches to dim and control a common light. Since each AL-WS-DR2 or AL-WS-010v device supports the N-Way input – the number of control points is limitless.

Note: DALI commands from other devices – such as ATX LED Hub or SR-GW-TDA receive commands from the Cloud ( Alexa, Google, etc) and output those on the DALI bus. These commands ( on, off, dim) override the local switch setting – operating as 3-Way switches. Therefore, rocker UP or DOWN will be inverted if a command has arrived from the cloud, for this reason, momentary type switches are preferred.

### N-Way signal options set via DALI command 35

Using the Dali command 35 (or memory location 0:15) – several modes are available. A DALI command 35 with the following values will select these advanced features

0	THREE WAY	Default – the external switch is “XOR” with the internal switch, classic 3-Way switching between Main and N-Way
1	DUAL SWITCH	Main and N-way operate independently. Main controls the Cool, and N-way controls the Warm Output. Set the 2 <sup>nd</sup> DALI address mode via memory bank 5:29 if N-Way traffic should go to the DA bus
2	FAN	Main switch controls the Cool LED output. This can trigger the Fan after a delay. N-Way can also turn the FAN on or off, or keep the Fan on for a settable Hold time. The Fan can be either a 12v or 48v fan, or other load that should be timed
3	NIGHT	Input signal (active High) on N-way pin sets an ON command at the Min Dim level, System can detect this and send dim sequence. Main switch operates normally
4	PIR mode	When a P023R6-M is connected, set this N-Way mode. The LED driver can be CCT, Fixed, Split, or FAN+Light. If CCT or Fixed, then all LEDs will follow the motion detected. If Split, then the Cool output On/Off/ Dim is set by the Main switch and address, while the warm level and motion reporting is conducted by the 2 <sup>nd</sup> DALI address.
6	Main Timeout	Each press of either main or N-Way button – turns the attached lights on for a programmable delay default is 10 minutes, this time can be changed by a DALI master. If Split driver mode, the Warm/Fan output will be controlled by the DALI 2 <sup>nd</sup> address unaffected by the timer on the Main channel
7	N-Way Timeout	Intended for Split driver operation. The Main switch has no timer and controls the Cool output. Each press of the N-Way switch – turns the Warm/FAN output on for a programmable delay – default is 10 minutes, this time can be changed by a DALI master.

## Split Main and N-Way / PIR Operations

### 2<sup>nd</sup> DALI Address operation

The Main switch or the N-Way input can be given a 2<sup>nd</sup> DALI address, set memory 0:15 to Split mode, set memory 5:30 to swap Main and N-Way if needed. Set the 2<sup>nd</sup> DALI address at address 5:29. Each press toggles On/Off, hold to dim.

Memory 5:29	Switch Action	Address
0-63	Send/Receive Short Address	0-63
64-79	Send/Receive Group Address	0-15
80-95	Send DALI 271 (0xBF)	0-15
96-111	Send DALI 271 + OnOff * 16	0-31
128-191	Send Only – Short Address	0-63
192-207	Send Only – Group address	0-15
208-223	Transmit Scene	0-15
224-239	Transmit Scene with Undo	0-14 ( 15 used for undo )
252	Send Broadcast off	All
253	Send Broadcast On @ max	All
254	Send Broadcast on/off/dim	All
255	Disabled	No action

The AL-WS-DR2 can have this 2<sup>nd</sup> DALI address assigned to the Warm/Fan output. This could be either the fan or a single color LED. See notes in the LED driver section. The device will operate as follows:

Memory 0:15 ( N-Way)	Memory 5:9 ( driver )	Function
Split	Split or Fan	N-Way 2 <sup>nd</sup> address controls Warm / Fan output and sends DALI signals. Main switch controls Cool output with DALI
FAN	Light + Fan	Fan operates on Timer from the light, or via N-Way
PIR mode	PIR mode	Changes in Current on the Warm output triggers a DALI command using the 2 <sup>nd</sup> address
Split	Not Split	N-Way sends DALI signals on the 2 <sup>nd</sup> address and does not affect either output
Not Split	Split	Warm/Fan output controlled by DALI only
Not Split	Not Split	DR2 operates as one device only, Main switch and N-way function as 3-way for all attached LEDs



# LED Driver operation modes

## Auto Detection

When the switch is turned on the first time, it will detect the LEDs attached. The auto detected modes are:

Fixed	if the # of LEDs on both sides are not equal	56 Watts Max
Fan	if there is a 4000 uF load ( fan load ) on the FAN output do not connect an on/off switch in series with the fan	40 Watts Max
CCT	the # of LEDs on both sides are equal	28 Watts Max
24v	If the series resistance indicates a 24v strip with less than 12 watts	16 watts Max

## CCT driver mode

In this mode, the total wattage between two connected strings of LEDs is the same, as the color is changed from one to the other. This implements color tuning. Press and hold the momentary main switch, and move the slider to change the color temperature. Color tuning is supported by DALI DT8 standards. The Wam and Cool outputs can be swapped after installation if needed using memory bank 5:10 and 5:11. Default is 0 = 5000K and 353 = 2700K.

Operating a CCT LED in fixed color mode will double the watts per fixture. This might exceed the specifications of the fixture and should be avoided.

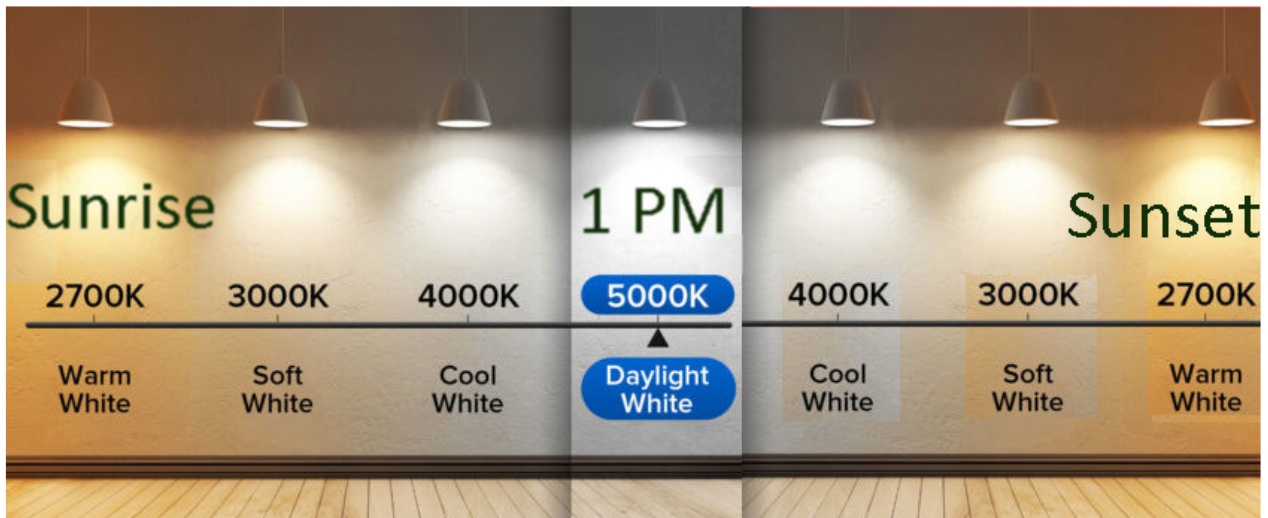

## Optional Time of Day lighting rhythm

### Dim to Warm

In CCT operation, the LEDs can be driven to shift to maximum warm light as the brightness is decreased. In ZWD, the % dim trigger level to control the shift can be set by the user as the “% Dim Level” at memory location 5:28. Default is 1.5%

## Fixed driver mode

In this mode, both outputs will have the same level. Move the slider to control brightness. If the number of LEDs is the same on both sides, the AL-WS-DR2 will default to CCT mode ( and appear as ½ brightness) – use the ZWD configuration tool to force fixed mode. Memory location bank 5 address 9 is set to 4 for Fixed mode or 3 for CCT mode.

## Split driver mode

In this mode, the outputs can be operated independently. Also enable N-Way split mode to allow the warm output to be controlled by the either the Main or N-Way switch, and by the 2<sup>nd</sup> DALI address if desired. See the Swap Main and N-Way section for allowing the Main switch to be exchanged with the N-Way.

## Split CC + inductive 12v CV mode

In this mode, the Cool output is Constant Current, 0-660 mA. The Warm output is Constant Voltage, 12v. These outputs can be operated independently or in tandem. Enable N-Way split mode to allow the warm output to be controlled by the N-Way switch, and by the 2<sup>nd</sup> DALI address if desired. Use the ZWD configuration tool force split CC+CV (12) mode.

## Resistive CV mode

Each output can be programmed to set the dimming range from 0 to a max voltage into a resistive load ( like a strip light). Not for DC-DC converter or capacitive loads. Set memory 5:6 and 5:7 to a voltage ( 48=48.0v ) and the AL-WS-DR2 will use that as the maximum voltage regardless of load. 24 volt strips will be automatically detected if they require 24v operation.

## FAN driver mode

An attached ATX LED 12v fan on the Warm / Fan, with it's 4000 uF capacitor will be auto detected, the DR2 will enter Fan mode automatically.

Do not use an on/off switch between the DR2 and the fan. Connect the fan to the DR2 before power is applied. The Fan is controlled by the N-Way input to the DR2.

In either case, the Fan N-Way mode will be enabled automatically. The default N-Way mode is no switch – therefore the FAN follows the Light. If an N-way switch is detected, other modes are enabled. See the section below “Exhaust Fan and Light Configuration and wiring” for operation of the N-Way in fan mode.

## Timer functions

There are three timer modes in the AL-WS-DR2:

Mode	Device Controlled	Turn On	Turn Off
Main Switch Timer	All LEDs attached	Press Main or N-Way	Press or Delay
N-Way Timer	Warm side only	Press N-Way	Press or Delay
Fan Timer	Warm or Fan	Press N-Way or Delay	Long Press or Delay

Use the Main timer for stairs and hallways with auto shutoff, use the N-Way timer for 48v fans or other warm side loads, use the Fan timer for Exhaust fans. Operation will be automatic, timed, or manual turn on / off from the N-Way switch

## Two LED CC drivers, one Fan CV Driver

The AL-WS-DR2 has one Current driver, and one current or voltage driver. Fan + Light and Fan-Only modes are automatically detected into voltage mode. CCT mode is detected automatically as well if both outputs have the same count of LEDs. Using the Dali memory write commands, any of these operational modes can be selected by the installer.

0	Auto	Default power up state – DR2 will count the attached LEDs or Fans and operate automatically. The DR2 powers up in Auto then changes depending on the attached hardware.
1	Split	Each 30 watt LED output operates independently by switch or by DALI. The Warm/Fan output is controlled by the N-Way input and the Cool is controlled by the main switch. If a 48v fan is attached, the use Split mode to control the fan.
2	LED + FAN	The Cool output is for 660 mA LEDs – up to 4* in series. The Main switch controls the LED. The Warm output is for a 12v 1 amp or less FAN – for example a SLM70-LVDC type fan with a 4000 uF input filtering. The fan is controlled by the N-Way, by DALI, or by timers associated with the LED being turned on. If no LED is connected, see function 2a
2a	Fan Only	If no LED is attached to the Cool output, and a 12v 1 amp FAN is connected on the Warm/Fan output, then the fan is controlled by the main switch, by timers, or by DALI. If a LED is also connected, see function 2
3	CCT	From 1 to 4* CCT type tunable white 660mA LED fixtures can be connected. 30 watts total is balanced between the two channels
4	Fixed	From 1 to 8* Fixed white fixtures can be connected, 4* on each side operate together. Same dimming levels on both driver outputs – up to 30 watts each side. Requires Hub to activate at 100% power – defaults to 50% until activated
5	PIR	The Warm output is always on at a defined current, changes in the load initiate DALI On/Off packets. The Cool output is controlled by the main switch or DALI.
6	LED+12vdc	Attach a 660mA dimmable LED to the Cool output. Attach any 12 volt load with up to 12 watts on the Warm/Fan output, dimming is not supported. Control is either all together or split depending on N-Way settings.
8	CCT Not Found	AUTO did not detect CCT. Operate at 50% power until either repaired or Fixed is activated

## Exhaust Fan and Light wiring

Do not place a switch between the fan and the DR2

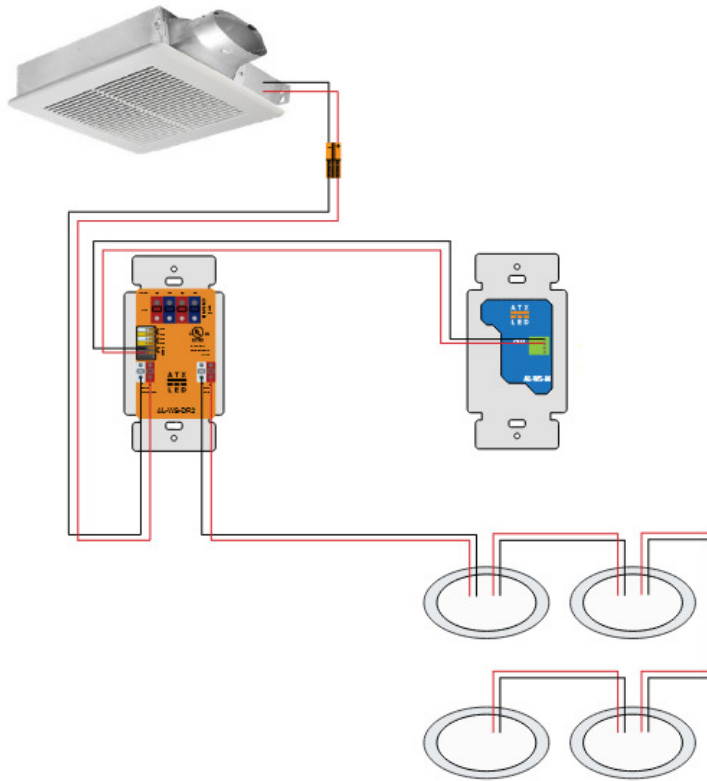

## Exhaust Fan DR2 configuration

Intended for exhaust fans, Warm output detects and powers the fan. The Cool output can drive LEDs or be left open. See below for operation details of what turns the fan on. Once on, Fan stays for for the “hold” time. An idle speed can be defined for make up air, the fan will always run at that speed. The maximum speed can be defined as well.

Memory bank:address	Function	Value	Default	Scale
0:15	FAN mode	2 = Use N-Way as the Fan On/Off switch	Auto detect	
5: 9	Driver mode	2 = Enable 12v fan operation	Auto detect	
5: 16	Fan Timer mode	0x2 = Follow Main light on/off 0x4 or 0x8 = Fan Timer all off – Fan follows Light	Follow	
5:22	Fan Idle	Sets the speed of the fan when it is 'off'	0	0-254
5:21	Delay before ON	Seconds x 4	90 seconds	0 – 1020
5:20	Hold-ON	Minutes	10 minutes	0 - 254
5:23	Fan Operate	Sets the speed of the fan when it is 'on'	254	50-254
5:29	Fan DALI Address	Set the address to control the Fan via DALI	Off ( 255)	0-63

# Exhaust Fan and Light Configuration

## ZWD configuration settings

▼ AL-WS-DR2 Fan  132

**Config**

Edit name:

Public name:

Visible to cloud:

Groups: 0 1 2 3 4 5 6 7  
8 9 10 11 12 13 14 15

Fade Up:  seconds

Fade Down:  seconds

Min Level:  1

Max Level:  254

Fail Level:  255

Power On Level:  Off  Last  Manual:

Split 2nd address:

Driver Mode:

N-Way Setting:

Slider Position:

Voltage (left):  Auto  V

**Status**

Channel: 1

Short address: 49

Model ID: AL-WS-DR2F32

UPC: 784099948190

Serial #: ca7d32bd

FW Version: 64

HW Version: 3

Phy Min Level: 1

## Fan Auto Timer

If Auto Timer is enabled by the user or by the installer, the Fan will turn on 90 seconds after the light is turned on. This time can be set by the Hub. The Fan will turn off automatically 10 minutes after the light is turned off. This time is also set by the Hub. The user can enable and disable this timer by pressing the N-Way switch if the N-Way has been installed. Press the N-Way as documented above for the desired operation.

## Fan Only Operation ( no light attached )

If no LED is attached on the cool side, the warm driver output will power the fan from the front main switch. In this case, the slider sets the fan speed. The Default values are used until a DALI hub changes them. A short tap of the main switch starts the fan, each tap after that, adds 5 minutes, and a long press turns the fan off. In this operation mode, the DALI hub can control the fan directly.

## Fan + LED Operation without N-Way

When an LED is connected on the Cool side, the main switch controls the light, and a timer controls the Fan. The times shown below can be changed by the DALI hub.

Function	Function – ( times are user settable) use DALI master to change times	N-Way wiring	User operation
Follow	Fan and Light operate together (default)	Open	no fan switch needed
Timer	Fan turns on after 90 seconds of light on, turns off automatically 10 minutes after light is turned off	Open	ATX Hub can enable/disable
Timer		Connect to Gnd	No hub or switch needed

## DALI Exhaust Fan control via 2<sup>nd</sup> Short Address

Independent DALI bus control of the FAN uses the 2<sup>nd</sup> short address method. It is possible to set the 2<sup>nd</sup> Short Address using the memory bank 5:29, this will become the dedicated address for the fan. On / Off and speed control is possible, local control using the N-Way switch remains active. Using address 5:16, disable Follow and Timer modes, or enable if needed. Bank 5:16 bit 1 enables/disables Fan and Light operate together. Bit 3 enables/disables the auto timer, bit 0 is high for momentary type switches, and low for rocker type.

### Fan + LED Operation with N-Way

When an LED is connected on the Cool side, the main switch controls that light, and an optional external switch controls the Fan. The times shown below can be changed by the DALI hub. Either a rocker style or momentary style switch can be used to control the fan.

#### Fan Switch Functions – N-Way Momentary style

Function	Function – ( times are user settable) use DALI master to change times	User operation
Auto Timer	Fan turns on after 90 seconds of light on, turns off automatically 10 minutes after light is turned off	User enables via short press if light is on. If fan is running, short press adds 5 minutes. Disabled by long press.
Manual Timer	Fan turns on immediately, turns off automatically 10 minutes after light is turned off	Starts via short press if light are off. Another short press adds 5 minutes, long press to stop
Manual Off	Turn fan off, disables Auto Timer	Stop the fan when running with long press

#### Fan Switch Functions – N-Way On/Off style

Function	Function – ( times are user settable) use DALI master to change times	User operation
Auto Timer	Fan turns on after 90 seconds of light on, turns off automatically 10 minutes after light is turned off	Leave Rocker On
Manual Timer	Fan turns on when switch is flipped on, turns off automatically after 10 minutes	Turn Rocker On, stop the fan by turning Rocker off
Manual Off	Turn fan off, disable Auto Timer	Turn Rocker Off.

## Advanced Diagnostics - Self Calibration

The AL-WS-DR2 has many features to make installation easy and reduce manual configuration steps. To do this, it self calibrates once the lights are turned ON the first time. The self calibration is a sequence of flashing lights – it takes up to 20 seconds, after that, it will not do that again – unless changes are made to the jumper settings or the # of LEDs or the type of LED. If needed – a recalibration can be forced – see the switch controls on how to force a reset and thus recalibration.

LEDs can be open, shorted, cross wired, backwards and nothing should break. You can hot swap the LEDs, change the number in series and the device will learn the setting at the next power cycle. The input voltage can be reversed without damage. However – connecting the input voltage to the LED output will cause immediate and permanent failure.

Do not hot swap Exhaust fans.

If the LEDs are flashing 4 times per second – this is a warning that the LEDs are cross wired – the Warm and Cool LEDs are cross wired. Note: it is an installation fault if plus of a LED from one driver returns thru the Minus of the opposite channel.

If the warm and cool channels have the same number of LEDs the device will operate in CCT mode. If Fixed LEDs are attached – they will operate at ½ power in CCT mode, and the light levels from the warm and cool side will change if ‘Color Tuning’ is conducted from the main switch. This is normal and easily changed to all Fixed using any DALI Master or the ATX LED Hub.

Ample diagnostics are available in memory bank #5 about the results of the self calibration, and the monitored state of the AL-WS-DR2.

Memory Location 68-69/70-71 provides the following information:

LED status bit 0:1	Register Value
1	LED output was shorted, the voltage is stored
3	The ohms was high – the ohms calculated is stored
0	Normal operation – the ohms per chip is stored

In 2019 and later hardware – the power reported assumes a 660 mA LED is attached; the AL-WS-DR2 measures how many LEDs are connected and performs the correct power calculation.

In the event that the number of attached LEDs is miscounted, the default value used to detect the number of LEDs can be adjusted. The default is 2500 mV at 5 mA. This value can be increased or decreased using memory location 5:78 and 5:79.

Telephone support is possible if the ATX LED Hub is online with internet. We can review the number of LEDs attached to each side of each AL-WS-DR2 and help resolve any problems.

# Trouble Shooting

If the LEDs do not turn on at full brightness, or flash – please check common causes;

1. Flashing the first time the light is turned on, or if the number of LEDs per side changes, this is the sequence of self calibration, please wait 1 minute for this to complete.
2. If no light – then the number of series LEDs is exceeded. The forward voltage of the LEDs is too great. The delivered voltage is between 7 and 42 volts ( with a 48 v supply) or 46 volts ( with a 54 volt supply). Check the forward voltage of the LEDs and add them up. For example, a 6 watt 360 mA bulb has 18 volts forward, a 6 watt 660 mA bulb is 9v.  
  
if your LEDs add up to more than 42 or 46 volts - they will not turn on at full brightness, and might not turn on at all.
3. Cross wiring. If the + of one side is connected via the LED to the – of the other side – then the LEDs will cycle on/off every 4 seconds.
4. If CCT LEDs are used – please use the ATX LED Hub to change the AL-WS-DR2 from fixed color to CCT. Otherwise – the colors will not change, and the LEDs will operate at 12 watts instead of 6 watts – it could be intended by the installer to operate at 12 watts per bulb for example with a P023R11 6 inch fixture. Operating a 6 watt fixture at 12 watts will decrease bulb life and could overload the home run to the power distribution panel.
5. If cable is used that is not copper ( see CCA anywhere on the wire label or box ? ) then there will be substantial loss in the wire. Please do not use CCA type wire of any kind
6. If the FAN does not turn on – use the ATX LED Hub for more information. .
7. Use the ATX LED Hub “pulse all” feature to verify that all devices are connected to the DALI bus
8. Use the ATX LED Hub / Advanced / Query DALI Power Status to verify that the DALI bus has 15 to 17 volts and no more than 260 mA
9. If the AL-WS-DR2 is operating in CCT mode when Fixed is expected, change to Fixed mode by holding the front switch down for 60 sections. Repeat that hold-operation to change back to CCT. This can also be done using a DALI master.
10. If two adjacent AL-WS-DR2 are interfering with the led output – we offer our FE Blocker to block any interference.

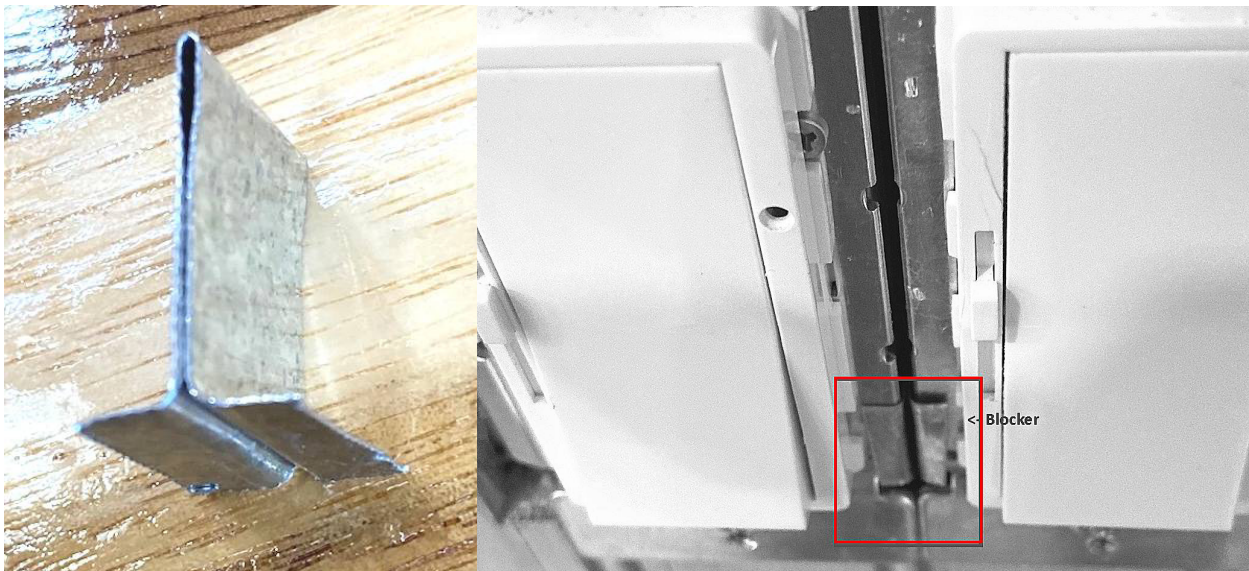



# Recommended ETL and UL listed LED's

## 51v power supply

LED rated watts	Type	Model	Size inches *	LED rating	DR2 Max Count	Total power output Watts	Note 51v input
6	Flat Ceiling	P023R6	3 / 5	660 mA	10	60	2x 4 series
6	Flat Ceiling	P023R6 CCT	3 / 5	660 mA	5	30	4 in series
12	Flat Ceiling	P023R11	6 / 7.5	720 mA	10	60 **	2x 4 in series
12	Flat Ceiling	P023R11 CCT	6 / 7.5	720 mA	5	30 **	4 in series
6	Recessed	DL-120 fixed	1 / 5	660 mA	10	60	2x 4 in series
6	Recessed	DL-120 CCT	1 / 5	660 mA	5	30	4 in series
6	Gimbal Spot	DL-98B CCT	2.75	660 mA	10	60	2x 4 in series
6	Bulb	RL-E26-660mA	E26	660 mA	10	60	2x 4 series
4	Bulb	RL-E12-660mA	E12	660 mA	14	56	2x 7 series
6	Bulb	E26-48v6w	E26	120 mA	12	72 ***	2x 6 Parallel
3	Bulb	E12-48v3w	E12	65mA	22	66 ***	2x 11 Parallel
14	Closet	FMMCL 18 840 S1 M4	18	360 mA	2	28	2x Parallel
7	Closet	FMMCL 840 S1 M4	7	360 mA	4	28	2x 2 in series
4w /ft	linear	P023S4	18****	720mA	12 ft	55 **	
4w /ft	linear	P023S4 CCT	18****	720mA	6 ft	28 **	
2w /ft	linear	P023S2	7****	660mA	28 ft	55	
2w /ft	linear	P023S2 CCT	7****	660mA	14 ft	28	
2w /ft	linear	48v CCT ATX flex strip	5	660mA	14 ft	28	Parallel
4w /ft	linear	24v CCT resistive strip	3	700 mA	60 ft	75	Cut in half – wire in series
6	Outdoor Small	ODB6	5	660 mA	8	6	2x 4 series

\*size 3 / 5 means 3 inch light source and 5 inch trim diameter

\*\* higher power using a 1440 mA driver like SRP-2309-75CCT

\*\*\* 96 watts with a simple On/Off switch

\*\*\*\* minimum cut length – can mix and match for any length.

# Recommended ETL and UL listed LED's

## 54v power supply

LED rated watts	Type	Model	Size inches *	LED rating	DR2 Max Count	Total power output Watts	Note 54v input
6	Flat Ceiling	P023R6	3 / 5	660 mA	10	60	2x 5 series
6	Flat Ceiling	P023R6 CCT	3 / 5	660 mA	5	30	5 in series
12	Flat Ceiling	P023R11	6 / 7.5	720 mA	10	60 **	2x 5 in series
12	Flat Ceiling	P023R11 CCT	6 / 7.5	720 mA	5	30 **	5 in series
6	Recessed	DL-120 fixed	1 / 5	660 mA	10	60	2x 5 in series
6	Recessed	DL-120 CCT	1 / 5	660 mA	5	30	5 in series
6	Gimbal Spot	DL-98B CCT	2.75	660 mA	10	60	2x 5 in series
6	Bulb	RL-E26-660mA	E26	660 mA	10	60	2x 5 series
4	Bulb	RL-E12-660mA	E12	660 mA	14	56	2x 7 series
6	Bulb	E26-48v6w	E26	120 mA	12	72 ***	2x 6 Parallel
3	Bulb	E12-48v3w	E12	65mA	22	66 ***	2x 11 Parallel
14	Closet	FMMCL 18 840 S1 M4	18	360 mA	2	28	2x Parallel
7	Closet	FMMCL 840 S1 M4	7	360 mA	4	28	2x 2 in series
4w /ft	linear	P023S4	18****	720mA	15 ft	60 **	
4w /ft	linear	P023S4 CCT	18****	720mA	7.5 ft	30 **	
2w /ft	linear	P023S2	7****	660mA	30 ft	60	
2w /ft	linear	P023S2 CCT	7****	660mA	15 ft	30	
2w /ft	linear	48v CCT ATX Flex strip	5	660 mA	14 ft	28	Parallel
4w /ft	linear	24v CCT resistive strip	3	660 mA	14 ft	56	Cut in half – wire series
6	Outdoor Small	ODB6	5	660 mA	8	6	2x 4 series

\*size 3 / 5 means 3 inch light source and 5 inch trim diameter

\*\* higher power using a 1440 mA driver like SRP-2309-75CCT

\*\*\* 96 watts with a simple On/Off switch

\*\*\*\* minimum cut length – can mix and match for any length.

# DALI Commands Supported

Notes: \* means must be sent twice in 100ms, A = ATX LED enhanced commands

## Individual Short Address Commands

	0	LED Off		
	1	UP 8 steps		
	2	Down 8 steps		
	3	UP one step but don't turn on, set fade to 0 for 3 seconds		
	4	Down one step but not off		
	5	Set to MAX level		
	6	Set to Min level		
	7	Down one step and Off if at 1		
	8	Up one step or on if at 0		
	32	Reset to defaults ( don't change Short Address)		
	33	Save brightness level to DTR		
A	35	Set N-Way mode ( DTR is the value ) same as memory 0:15		See table
A	38	Set light on/off to reflect Mechanical switch Up/Down		
	42	Store DTR as Max Level,		
	43	Store DTR as Min Level		
	44	Store DTR as Light level should the DALI bus be disconnected – default 255 means no action		
	45	Store DTR as power up level, 0 is off, 2 is remember last setting, 3-254 is a brightness level		
	46	Store DTR as Fade Up duration ( see table )		
	47	Store DTR as Fade Down duration ( see table )		
A	49	Set UPS mode and use DTR as temporary Max Level	Min to 254	255 = reset
*	129	Enable memory Bank write		
	144	Query Status ( if set, indicates status below )		
	bit 0	Warm Led Connected, or Fan connected		
	bit 1	Cool Led Connected		
	bit 2	Either Led ON		
	bit 3	ARC setting out of range, or LED shorted		
	bit 4	Fade in action, or Fan in spooling up/down		
	bit 5	Device not yet configured after a reset		
	bit 6	Missing Short Address		
	bit 7	No ARC level set after power failure or last change not stored in EEPROM		
	145	Query if DR2 is present		
	146	Query if either attached LED fail		
	147	Query if LED on		
	148	Query if ARC command exceeded Min / Max limits		
	149	Query if in Reset state		
	150	Query if no address assigned		
	151	Query DALI version number ( == 1)		
	152	Query DTR		
	153	Query LED type ( no CCT == 6 or CCT == 8)		
	154	Query Physical DIM level		
	155	Query Power Failure		
	156	Query DTR 1		
	157	Query DTR 2		
A	158	Query N-Way mode		
	160	Query Actual Dim Level		
	161	Query Max Level		

	162	Query Min Level
	163	Query Power On Dim Level
	164	Query System Fail Level
	165	Query Fade Rate value
A	166	Query HW Type ( 1 == DR2)
	192	Query group association 0-7
	193	Query group association 8-15
	194	Query Random High bits
	195	Query Random Middle bits
	196	Query Random Low bits
	197	Query Memory Bank address DTR1:DTR DTR1 is memory bank, DTR is address ( auto increment DTR to next address )
	226	Save CCT Color from DTR1 and DTR
	231	Set CCT Color from DTR1 and DTR
	232	Set CCT cooler by 10%
	233	Set CCT warmer by 10%
	247	Query CCT type ( == 1 )
	248	Query CCT type ( == 32)
	249	Query CCT type ( == 2 )
	250	Query CCT color now – DTR1 = MSB, DTR = LSB
	255	Query CCT status ( 209 if CCT enabled )

**Global Commands – processed by all DALI devices on the bus**

	256	Terminate	
	257	Set DTR, set DTR lockout 200 ms	
*	258	Initial Addressing Mode	
*	259	Randomize	
	260	Compare Random Address	
	261	Withdraw from Random Addressing	
	264	Set High Byte	
	265	Set Middle Byte	
	266	Set Low Byte	
	267	Set Short Address if match	
	268	Query Short Address	
	269	Query Long Address Match	
	270	End Addressing modes	
	272	Enable CCT commands if CCT mode enabled	
	273	Set DTR1, set DTR lockout 200 ms	
	274	Set DTR2, set DTR lockout 200 ms	
	275	Write Data at Memory Bank DTR1:DTR	Send confirm
	276	Write Data at Memory Bank DTR1:DTR	no response

## DTR Lockout feature

If the AL-WS-DR2 detects any DTR set functions on the bus, it will block any DALI transmit commands for 200ms. Since DTR commands are often part of a sequence of DALI commands, this lockout prevents any ATX LED device from sending any command that can interfere with a that sequence. This will delay any AL-WS-DR2 initiated command, for example switch turned on / off or CCT changes.

## Memory Bank 0 (DTR1 = 0)

DTR register	Bank 0 Name	Bank 0 Value
0	Bytes per Bank ( minus 1)	63
1	Checksum	Calculated
2	Number of Banks ( minus 1)	3
3	UPC code – msb	See table
4	UPC code	
5	UPC code	
6	UPC code	
7	UPC code	
8	UPC code – lsb	
9	FW Version	
10	HW Version	
11	Serial Number – msb	Assigned by Master
12	Serial Number	
13	Serial Number	
14	Serial Number – lsb	
15	N-Way Mode	Read/Write See details
17-63	Storage	User Defined

### UPC Codes:

722512407176 AL-WS-DR2 v0 (2018)  
 722512407183 AL-WS-DR2 v1 (2019)  
 784099948268 AL-WS-DR2 v2 (2019)  
 784099948190 AL-WS-DR2 v3 (2020)  
 784099948190 AL-WS-DR2 v4 (2023)  
 784099948206 AL-WS-DR2C v4 (2023)

## Memory Bank 1-3 (DTR1 = 1,2,3)

DTR register	Name	Value
0	Bytes per Bank ( minus 1)	63
1	Checksum	calculated
2	Number of Banks ( minus 1)	3
3-63	User Storage	

## Memory Bank 4 real time data (DTR1 = 4)

DTR register	Name	Value
3, 4	Up Time lsb (3) msb (4)	Hours
5, 6	On Time lsb (5) msb (6)	Hours
12	Wh/10	99 = 990 Wh add to kWh below
7, 8	kWh lsb (7) msb (8)	kWh
9	Average Watts since boot	Watts
10	Peak Watts	Peak when LEDs at 100% Watts
11	UPS mode Now	Power limited output level 20-254
13	Watts Now	Watts Total
14, 15	Input Voltage Now lsb (14) msb (15)	Vin Milli Volts
16, 17	Warm Wattage Now lsb (16) msb (17)	Vled milli Watts
18, 19	Cool Wattage Now lsb (18) msb (19)	Vled milli Watts

## Read/Writable Memory Bank 5 (DTR1 = 5)

1	Transmit Group	0-15 means send group 255 means send short address
6	Warm Max Voltage	Volts 9-54
7	Cool Max Voltage	Volts 9-54
9	Driver Operation mode	0 = Auto and calibrate 1 = Fixed Split 2 = Led plus 12v FAN 3 = CCT 4 = Fixed 5 = PIR 6 = CC cool, 12v CV Wam / Fan
10	DALI value for 100% Warm	Default is 176 = 2700K (Warm)
11	DALI value for 100% Cool	Default is 0 = 5000K (Cool)
16	N-Way Fan operation	0x01 = PB 0x02 = Follow 0x04 = Timer 0x08 = Timer
20	Fan Hold time	Minutes ( 240 = 4 hours)
21	Fan Delay to On	255 = 1020 seconds
22	Fan Idle Voltage	0 = 5.5 volts, 254 = 10 volts
23	Fan Max Voltage	0 = 5.5 volts, 254 = 12 volts
28	Warm Shift (S) mA threshold for Dim to Warm (m)	$S * 16 + m / 2$
29	DALI address of Split N-Way DALI Group address 0-15, Scene 0-15 broadcast / Disable	see detail
30	Slider Left/Right Swap Main and N-Way	1 or 64 left slider, 0 is right slider, no swap 7 is left slider, 2 is right slider, swapped
40/41 ( 16 bit)	Max current from driver Warm*	Read 16 bits = 20 to 660 mA
42/43 ( 16 bit)	Max current from driver Cool*	Read 16 bits = 20 to 660 mA
76	CCT fade time	Seconds / 10 ( 255 = 40 minutes)
78	LED Vf adjustment Right signed	+ - mV per LED rung ( 10 = 100 mV )
79	LED Vf adjustment Left signed	+ - mV per LED rung ( -10 = -100 mV )
80	Force reduced Driver Physical Max Warm	Value 165 = 660 mA typically
81	Force reduced Drive Physical Max Cool	Value 165 = 660 mA typically

## Read Only Diagnostics in Memory Bank 5 (DTR1 = 5)

8	CCT_Level Ratio of Warm to Cool outputs	0-100
13	N Way Mode	See command 35
14	Last Control	1=local off 2=local on 4=DALI off 5=DALI on
24/25 W 26/27 C	High Power converter minimum LSB/MSB	mVolts
32/33 W 34/35 C	Low current driver Turn on LSB/MSB real time	120 typically  70-220 counts
36/37 W 38/39 C	LED Voltage at 3 mA	7500 to 50000 mVolts
40/41 W 42/43 C	High Power Converter Max LSB/MSB	660 typically 600-720 range
44 W 45 C	Number of series LED chips	Number of 3v chips
46 W 47 C	High Power Driver Max mA	1 or 3 = 660/720 mA 2 or 6 = 300/360 mA
48 49 50	Driver Status Warm, Fan Cool	1 = Short 2 = Open 3 = Crossed LEDs 4 = Good LED, Fan, off 12 = Good LED, on
52/53 W 54/55 C	Low current driver Max LSB/MSB	200-1023 35 uA per step
56/57 W 58/59 C	Voltage of the LEDs real time	0 to 56000 mVolts
60-63	WattMinutes (32 bits)	Wh*60
64/65 W 66/67 C	Low Drive max	0-1000 is 0-30mA
68/69 W 70/71 C	LED array diagnostics	See notes
72/73 W 74/75 C	LED Voltage at 660 mA	7500 to 50000 mVolts
76	CCT Fade time	10s of seconds