

CMS02P06T6-HF

P-Channel
RoHS Device
Halogen Free

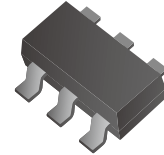

Features

- Advanced high cell density trench technology.
- Super low gate charge.
- Excellent cdv/dt effect decline.
- Green device available.

Mechanical data

- Case: SOT-26 standard package, molded plastic.

Circuit Diagram

- G : Gate
- S : Source
- D : Drain

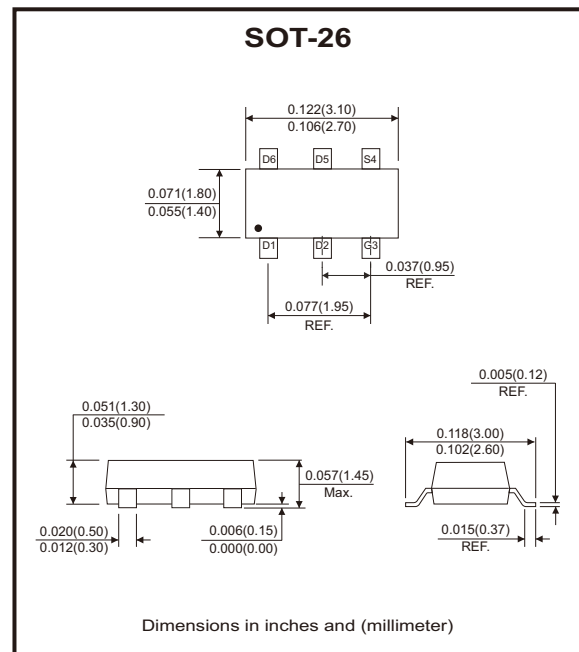
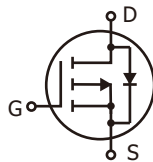

Maximum Ratings

Parameter	Conditions	Symbol	Value	Unit
Drain-source voltage		V_{DS}	-60	V
Gate-source voltage		V_{GS}	± 20	V
Continuous drain current, V_{GS} @ 10V (Note 1)	I_D @ $T_A = 25^\circ C$		-2.4	A
	I_D @ $T_A = 70^\circ C$		-1.7	
Pulsed drain current (Note 2)		I_{DM}	-4.5	A
Power dissipation (Note 3)	P_D @ $T_A = 25^\circ C$		1.1	W
Linear derating factor			0.009	W/ $^\circ C$
Operating junction temperature range		T_J	-55 to +150	$^\circ C$
Storage temperature range		T_{STG}	-55 to +150	$^\circ C$
Thermal resistance junction-ambient (Note 1)		$R_{\theta JA}$	110	$^\circ C/W$

Electrical Characteristics (at T_J=25°C unless otherwise noted)

Parameter	Symbol	Conditions	Min	Typ	Max	Unit
Drain-source breakdown voltage	BV _{DSS}	V _{GS} = 0V, I _D = -250μA	-60			V
Gate threshold voltage	V _{GS(th)}	V _{DS} = V _{GS} , I _D = -250μA	-1.0		-3.0	V
Forward transconductance	g _{fs}	V _{DS} = -10V, I _D = -2A		5.8		S
Gate-source leakage current	I _{GSS}	V _{GS} = ±20V			±100	nA
Drain-source leakage current (T _J =25°C)	I _{DSS}	V _{DS} = -48V, V _{GS} = 0V			-1	μA
Drain-source leakage current (T _J =55°C)		V _{DS} = -48V, V _{GS} = 0V			-5	
Static drain-source on-resistance (Note 2)	R _{DS(on)}	V _{GS} = -10V, I _D = -2A			175	mΩ
		V _{GS} = -4.5V, I _D = -1A			220	
Total gate charge (Note 2)	Q _g	V _{DS} = -20V, I _D = -2A, V _{GS} = -4.5V		4.6		nC
Gate-source charge	Q _{gs}			1.39		
Gate-drain ("miller") charge	Q _{gd}			1.62		
Turn-on delay time (Note 2)	t _{d(on)}	V _{DS} = -15V, V _{GS} = -10V I _D = -1A, R _G = 3.3Ω		17.4		nS
Rise time	t _r			5.4		
Turn-off delay time	t _{d(off)}			37.2		
Fall time	t _f			2.4		
Input capacitance	C _{iss}	V _{GS} = 0V, V _{DS} = -15V, f = 1MHz		531		pF
Output capacitance	C _{oss}			59		
Reverse transfer capacitance	C _{rss}			38		
Source-drain diode						
Diode forward voltage (Note 2)	V _{SD}	I _S = -1A, V _{GS} = 0V, T _J =25°C			-1.2	V
Continuous source current (Note 1, 4)	I _S	V _G = V _D = 0V, Force current			-2.4	A
Pulsed source current (Note 2, 4)	I _{SM}				-4.5	A

Notes: 1. Surface mounted on a 1 inch² FR-4 board with 2 oz copper.

2. The data tested by pulsed, pulse width ≤300μs, duty cycle ≤ 2%.

3. The power dissipation is limited by 150°C junction temperature.

4. The data is theoretically the same as I_D and I_{DM}, in real applications, should be limited by total power dissipation.

Rating and Characteristic Curves (CMS02P06T6-HF)

Fig.1 - Typical Output Characteristics

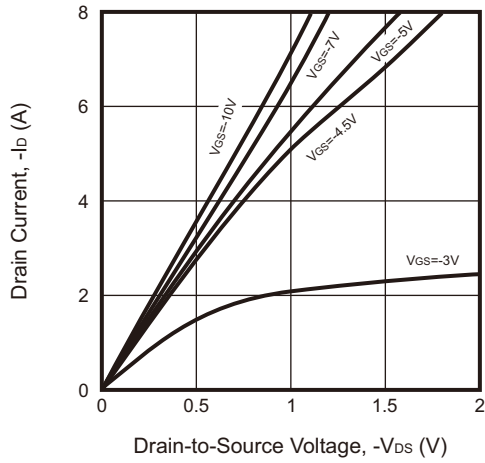

Fig.2 - On-Resistance vs. G-S Voltage

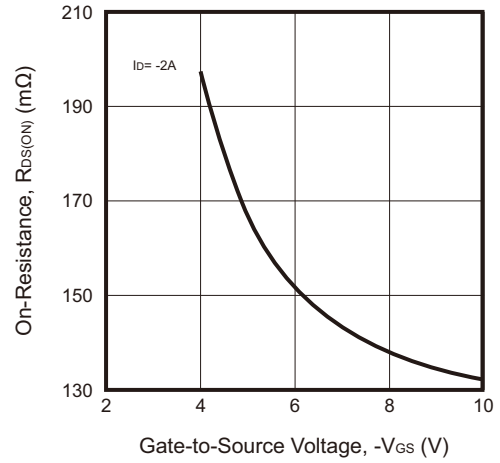

Fig.3 - Normalized $V_{GS(th)}$ vs. T_J

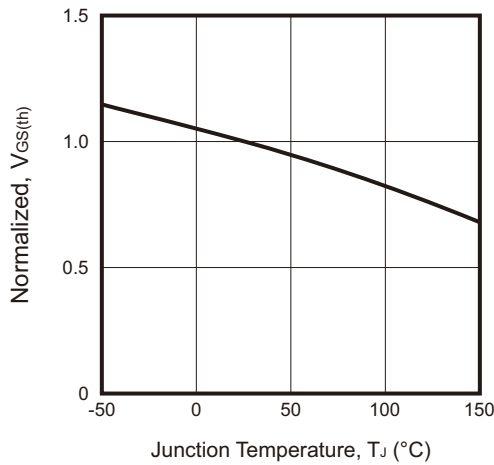

Fig.4 - Normalized $R_{DS(ON)}$ vs. T_J

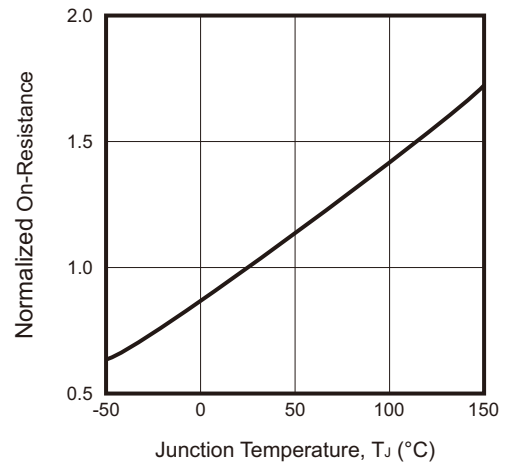

Fig.5 - Safe Operating Area

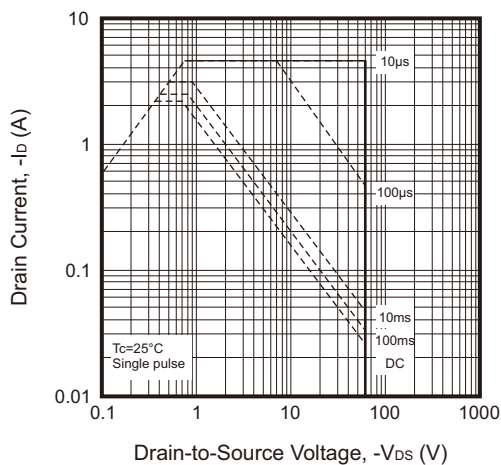
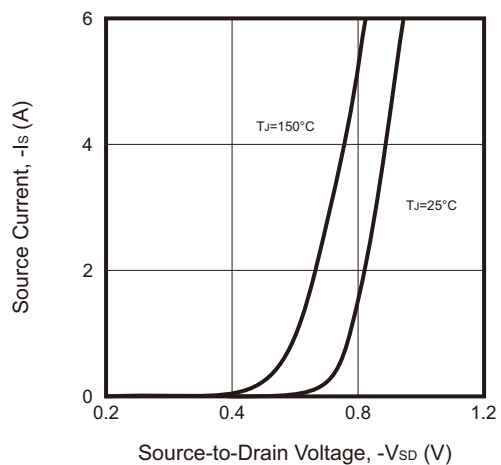

Fig.6 - Forward Characteristics of Reverse



Rating and Characteristic Curves (CMS02P06T6-HF)

Fig.7 - Gate Charge Characteristics

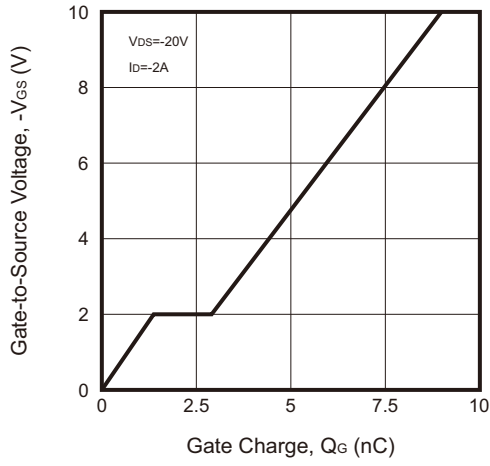
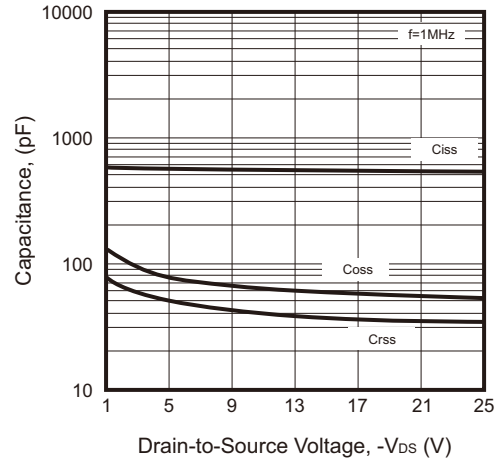
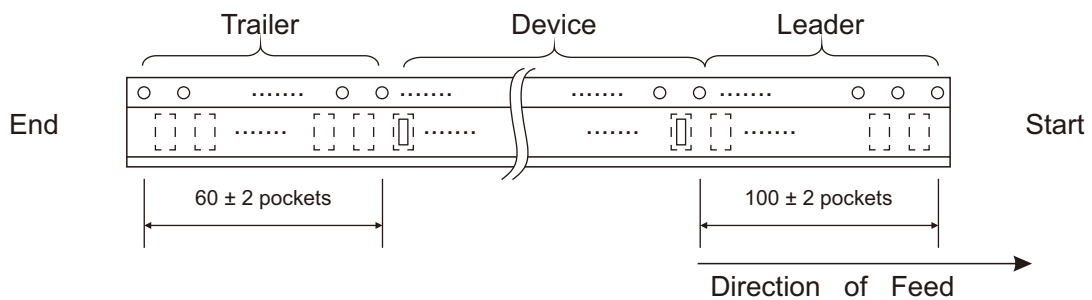
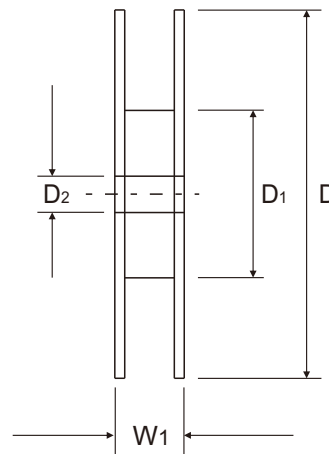
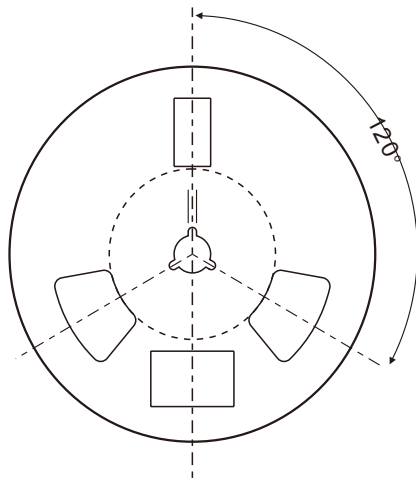
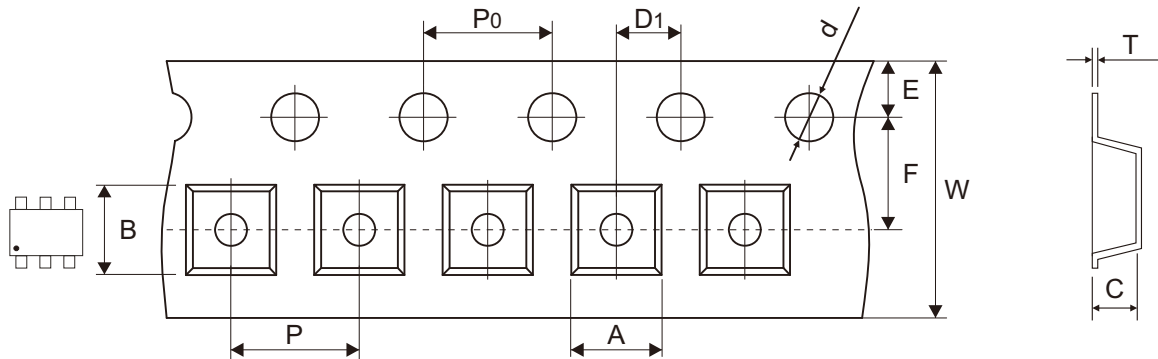

Fig.8 - Capacitance Characteristics



Reel Taping Specification



SOT-26	SYMBOL	A	B	C	d	D	D1	D2
	(mm)	3.30 ± 0.10	3.24 ± 0.10	1.45 ± 0.10	1.50 + 0.10 - 0.00	178 ± 0.50	54.5 + 2.50 - 0.00	13.00 + 0.35 - 0.15
	(inch)	0.130 ± 0.004	0.128 ± 0.004	0.057 ± 0.004	0.059 + 0.004 - 0.000	7.008 ± 0.020	2.146 + 0.098 - 0.000	0.512 + 0.014 - 0.006

SOT-26	SYMBOL	E	F	P	P0	P1	T	W	W1
	(mm)	1.75 ± 0.10	3.50 ± 0.05	4.00 ± 0.10	4.00 ± 0.10	2.00 ± 0.10	0.23 ± 0.04	8.00 + 0.30 - 0.10	12.00 + 1.50 - 0.50
	(inch)	0.069 ± 0.004	0.138 ± 0.002	0.157 ± 0.004	0.157 ± 0.004	0.079 ± 0.004	0.009 ± 0.002	0.315 + 0.012 - 0.004	0.472 + 0.059 - 0.020

Company reserves the right to improve product design , functions and reliability without notice. REV:A

Marking Code

Part Number	Marking Code
CMS02P06T6-HF	2611B

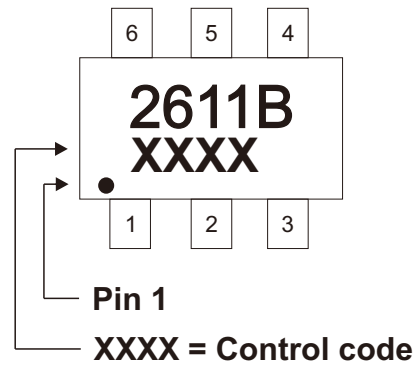

Suggested PAD Layout

SIZE	SOT-23-6	
	(mm)	(inch)
A	1.00	0.039
B	0.70	0.028
C	0.95	0.037
D	2.40	0.094

Note: 1. The pad layout is for reference purposes only.

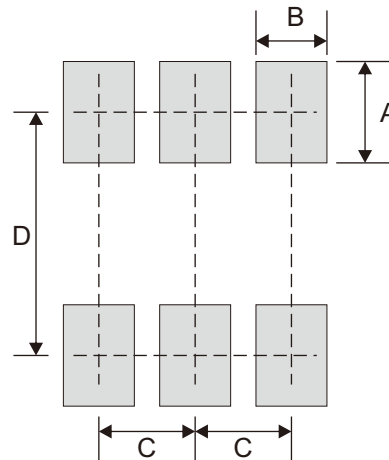

Standard Packaging

Case Type	REEL PACK	
	REEL (pcs)	Reel Size (inch)
SOP-26	3000	7