

Data sheet

11233.1

PKB 950/5/5,08 GN

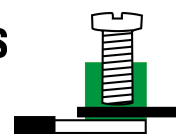
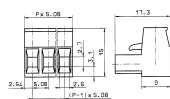
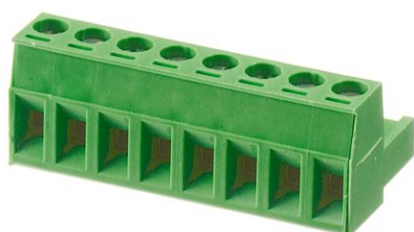

M3

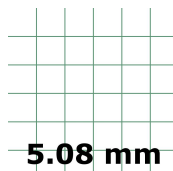

5.08 mm



Female socket block, Screw connection, No. of poles: 5, Width: 25.4 mm, Colour: Green

Business data

Connector version	Free connector
Packaging unit	50
Quantity unit	PC
Packaging type	Carton
Type of banding	Without
Weight per piece (not including packaging)	7.8 g
Weight per piece (including packaging)	8.5 g
Unit of weight	G
Customs number	85366930
Country of origin	TN

11233.1

PKB 950/5/5,08 GN

Technical data

Dimensions

Length	15 mm
Width	25.4 mm
Width left	2.54 mm
Width right	2.54 mm
Height	17.3 mm
Pitch	5.08 mm

Ratings

Rated voltage	250 V
Rated current	12 A
Rated cross-section	2.5 mm ²
Rated impulse voltage	4 kV
Overvoltage category	III
Contamination degree	3

Technical data

Connection data

Connection principle	Screw connection
Angle of wire connection/contact	0°/180° (horizontal)
Number of plug-in rows	1
No. of poles	5
Contact version	Female connector
Wire cross-section single-core (rigid) / stranded, min.	0.2 mm ²
Wire cross-section single core (rigid)/stranded, max.	4 mm ²
Wire cross-section stranded, min.	0.2 mm ²
Wire cross-section stranded, max.	2.5 mm ²
Wire cross-section stranded with wire-end ferrules, min.	0.25 mm ²
Wire cross-section stranded with wire-end ferrules, max.	2.5 mm ²
Wire cross-section AWG, min.	22
Wire cross-section AWG, max.	12
Stripping length	6 mm
Screw threading	M 3
Torque	0.5 Nm

Materials

Insulation housing	Polyamide 6.6
Flammability class UL 94	V-0
Working temperature, min.	-30 °C
Working temperature, max.	105 °C
Clamping element	Brass
Contact spring	Bronze
Screws	Steel

11233.1

PKB 950/5/5,08 GN

Technical data

Further technical data

Storage temperature, min.	-40 °C
Storage temperature, max.	105 °C
Insulation resistance	1*10 ¹³ Ohm x cm
Creepage-current resistance	CTI 600
Glow wire flammability index GWFI	GWFI 850
GWFI after-glow time	30 Sek.
Glow wire ignition temperature GWIT	GWIT 775 °C
GWIT exposure time	5 Sek.
Connection cycles, in compliance with standard	5
Plug-in cycles acc. to standard	100

Print

Colour	Green
--------	-------

Environmental Product Compliance

REACH Conform	No
REACH Reference date	2021-07-08
REACH Candidate Substance Note	No
REACH CAS 1 Substance	LEAD
REACH CAS 1 Percent minimal	0.1 %
REACH CAS 1 Percent maximum	4 %
REACH CAS 1 Number	7439-92-1
RoHS Conform	yes
RoHS Exception rule	6c

11233.1

PKB 950/5/5,08 GN

Approvals

cUL Recognized

cUL approval	CSA 22.2 No.158
cUL Usegroup B: rated voltage	300 V
cUL Usegroup B: rated current	15 A
cUL Usegroup C: rated voltage	150 V
cUL Usegroup C: rated current	15 A
cUL Usegroup D: rated voltage	300 V
cUL Usegroup D: rated current	10 A
cUL wire cross-section single-core (rigid) AWG, min.	22
cUL wire cross-section single-core (rigid) AWG, max.	12
cUL wire cross-section stranded AWG, min.	22
cUL wire cross-section stranded AWG, max.	12
cUL torque	0.5 Nm
cUL wire material	Cu
cUL Recognized	yes

11233.1

PKB 950/5/5,08 GN

Approvals

UL Recognized

UL approval	UL 1059
UL Usegroup B: rated voltage	300 V
UL Usegroup B: rated current	15 A
UL Usegroup C: rated voltage	150 V
UL Usegroup C: rated current	15 A
UL Usegroup D: rated voltage	300 V
UL Usegroup D: rated current	10 A
UL wire cross-section single-core (rigid) AWG, min.	22
UL wire cross-section single-core (rigid) AWG, max.	12
UL wire cross-section stranded AWG, min.	22
UL wire cross-section stranded AWG, max.	12
UL torque	4.43 Lb In
UL wire material	Cu
UL factory wiring	yes
UL field wiring	yes
UL Recognized	yes

Approvals

VDE approval

VDE approval	DIN EN 61984
VDE approval granted	yes
VDE rated voltage	250 V
VDE rated current	12 A
VDE rated current wire cross-section rigid, min.	5 A
VDE rated current wire cross-section rigid, max.	12 A
VDE rated current wire cross-section stranded, min.	5 A
VDE rated current wire cross-section stranded, max.	12 A
VDE rated impulse voltage	4 kV
VDE wire cross-section rigid, min.	0.5 mm ²
VDE wire cross-section rigid, max.	2.5 mm ²
VDE wire cross-section stranded, min.	0.5 mm ²
VDE wire cross-section stranded, max.	2.5 mm ²
VDE screw threading	M 3
VDE torque	0.5 Nm
VDE overvoltage category	III
VDE contamination degree	3

11233.1

PKB 950/5/5,08 GN

Media

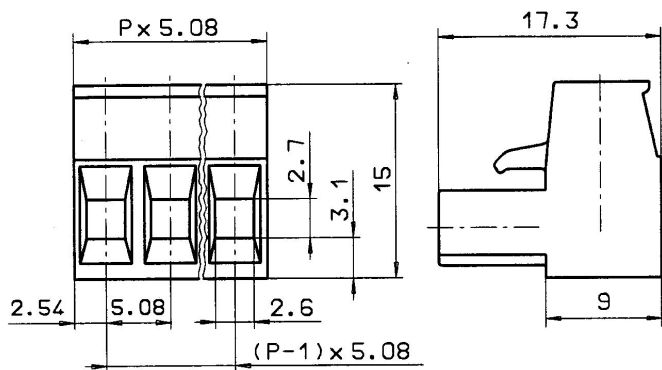

CRA[®] US

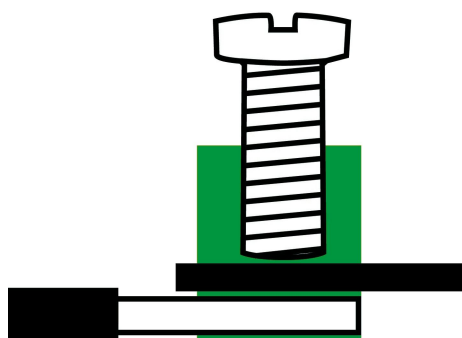

M3

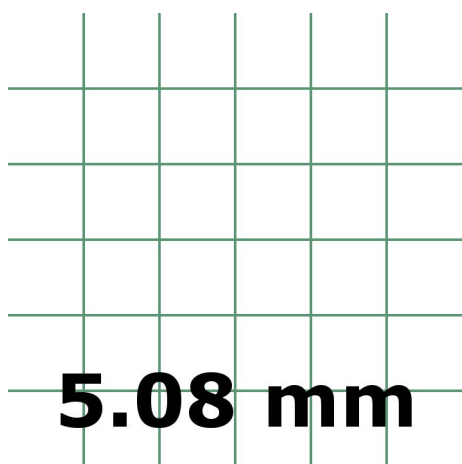

Data sheet

11233.1

PKB 950/5/5,08 GN



Accessories
