

Data sheet | Item number: 2116-5207

2-conductor ground terminal block; with lever and push-button; 16 mm²; with test port; side and center marking; for DIN-rail 35 x 15 and 35 x 7.5; Push-in CAGE CLAMP®; 16,00 mm²; green-yellow



www.wago.com/2116-5207



Color:

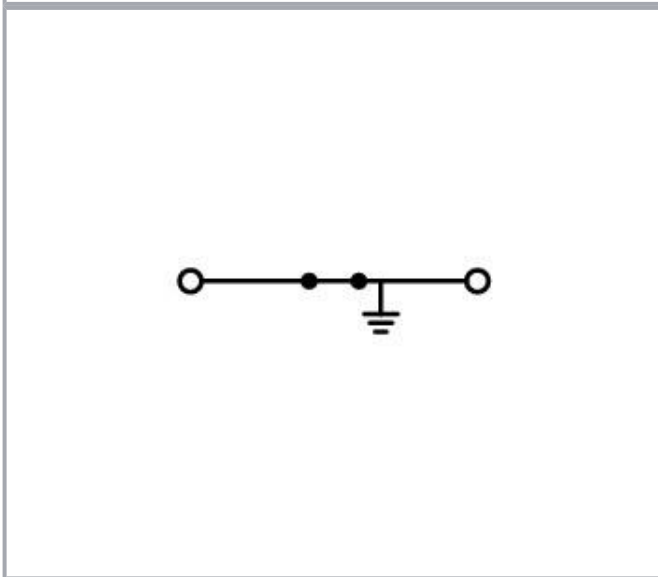
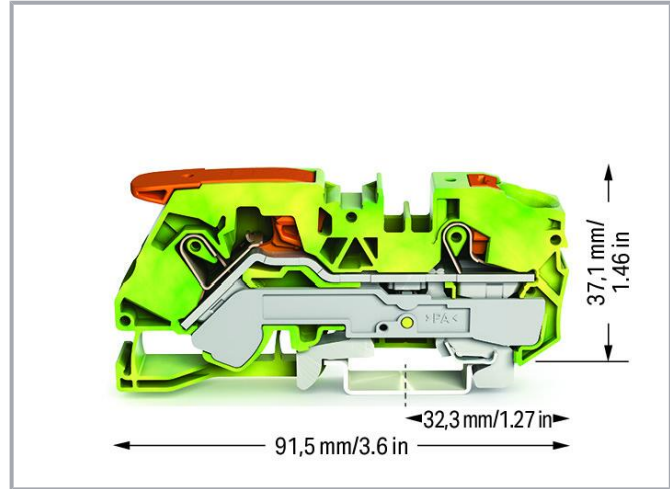

Data

Electrical data

Ratings per IEC/EN

Ratings per

IEC/EN 60947-7-2

Note (rated current)

15 mm high DIN-35 rails shall be used for a current load higher than

Subject to changes. Please also observe the further product documentation!

WAGO GmbH & Co. KG
Hansastr. 27
32423 Minden
Phone: +49571 887-0 | Fax: +49571 887-169
Email: info.de@wago.com | Web: www.wago.com

Do you have any questions about our products?
We are always happy to take your call at +49 (571) 887-44222.

76 A!

Ex information

Reference hazardous areas

See "Downloads – Documentation – Additional Information: Technical Section; Technical Explications"

Connection data

Connection points	2
Total number of potentials	1
Number of levels	1
Number of jumper slots	2

Connection 1

Connection technology	Push-in CAGE CLAMP®
Actuation type	Lever
Connectable conductor materials	Copper
Nominal cross-section	16 mm ²
Solid conductor	0.5 ... 16 mm ² / 20 ... 6 AWG
Solid conductor; push-in termination	2.5 ... 16 mm ² / 14 ... 6 AWG
Fine-stranded conductor	0.5 ... 25 mm ² / 20 ... 4 AWG
Fine-stranded conductor; with insulated ferrule	0.5 ... 16 mm ² / 20 ... 6 AWG
Fine-stranded conductor; with ferrule; push-in termination	6 ... 16 mm ² / 10 ... 6 AWG
Note (conductor cross-section)	Depending on the conductor characteristic, a conductor with a smaller cross-section can also be inserted via push-in termination.
Strip length	18 ... 20 mm / 0.71 ... 0.79 inches
Wiring direction	Front-entry wiring

Connection 2

Actuation type 2	Push-button
------------------	-------------

Physical data

Width	12 mm / 0.472 inches
Height	91.5 mm / 3.602 inches
Depth from upper-edge of DIN-rail	37.1 mm / 1.461 inches

Subject to changes. Please also observe the further product documentation!



Mechanical Data

Mounting type	DIN-35 rail
Marking level	Center/side marking

Material Data

Note (material data)	Information on material specifications can be found here
Color	green-yellow
Material group	I
Insulation material	Polyamide (PA66)
Flammability class per UL94	V0
Fire load	0.21 MJ
Weight	40.2 g

Environmental requirements

Continuous operating temperature	-60 ... +105 °C
----------------------------------	-----------------

Commercial data

eCl@ss 10.0	27-14-11-41
eCl@ss 9.0	27-14-11-41
ETIM 8.0	EC000901
ETIM 7.0	EC000901
PU (SPU)	20 pcs
Packaging type	box
Country of origin	DE
GTIN	4055143754453
Customs tariff number	85369010000

Environmental Product Compliance

RoHS Compliance Status	Compliant, No Exemption
------------------------	-------------------------

Approvals / Certificates



General approvals

Logo	Approval	Additional Approval Text	Certificate name
------	----------	--------------------------	------------------



Subject to changes. Please also observe the further product documentation!

	CCA DEKRA Certification B.V.	EN 60947	NTR NL 7675
	CCC CNEX	GB/T 3836.3	2020312313000183 (Ex eb IIC Gb, Ex eb I Mb)
	CSA DEKRA Certification B.V.	C22.2	70175104
	cURus Underwriters Laboratories Inc.	UL 1059	E45172
	KEMA/KEUR DEKRA Certification B.V.	EN 60947	71-103140

Declarations of conformity and manufacturer's declarations

Logo	Approval	Additional Approval Text	Certificate name
	EU-Declaration of Conformity WAGO GmbH & Co. KG	-	-
	UK-Declaration of Conformity WAGO GmbH & Co. KG	-	-

Approvals for marine applications

Logo	Approval	Additional Approval Text	Certificate name
	ABS American Bureau of Shipping	-	19- HG1866350- PDA
	BV Bureau Veritas S.A.	IEC 60947	58186/A0 BV

Subject to changes. Please also observe the further product documentation!

WAGO GmbH & Co. KG
Hansastr. 27
32423 Minden
Phone: +49571 887-0 | Fax: +49571 887-169
Email: info.de@wago.com | Web: www.wago.com

Do you have any questions about our products?
We are always happy to take your call at +49 (571) 887-44222.



DNV GL
Det Norske Veritas, Germanischer Lloyd

-

TAE00003JT



LR
Lloyds Register

-

19/20050

Approvals for hazardous areas

Logo	Approval	Additional Approval Text	Certificate name
	AEx UL International Germany GmbH c/o Physikalisch Technische Bundesanstalt	UL 60079	E185892
	ATEX Physikalisch Technische Bundesanstalt	EN 60079-0	PTB ATEX 1012 U (II 2 G Ex eb IIC Gb bzw. I M 2 Ex eb I Mb)
	CCC CNEX	GB/T 3836.3	2020312313000183 (Ex eb IIC Gb, Ex eb I Mb)
	EAC Brjansker Zertifizierungsstelle	TP TC 012/2011	RU C-DE.AM02.B. 00127/19 (Ex e IIC Gb U)
	IECEX Physikalisch Technische Bundesanstalt	IEC 60079-0	IECEX PTB 18.0019U (Ex eb IIC Gb and Ex eb I Mb)
	INMETRO TÜV Rheinland do Brasil Ltda.	IEC 60079	TÜV 19.0819 U

Required accessories

End plate

End plate



Item no.: 2116-1291
End and intermediate plate; 1 mm thick; gray

www.wago.com/2116-1291

Item no.: 2116-1292

Subject to changes. Please also observe the further product documentation!



End and intermediate plate; 1 mm thick; orange

www.wago.com/2116-1292

Optional accessories

Marking accessories

Marking strip



Item no.: 2009-110

Marking strips; for Smart Printer; on reel; not stretchable; plain; snap-on type; white

www.wago.com/2009-110

Marker carrier



Item no.: 2009-198

Adaptor; gray

www.wago.com/2009-198

Marker



Item no.: 2009-115/000-002

WMB-Inline; for Smart Printer; 1500 pieces on roll; stretchable 5 - 5.2 mm; plain; snap-on type; yellow

www.wago.com/2009-115/000-002



Item no.: 2009-115/000-007

WMB-Inline; for Smart Printer; 1500 pieces on roll; stretchable 5 - 5.2 mm; plain; snap-on type; gray

www.wago.com/2009-115/000-007



Item no.: 2009-115/000-017

WMB-Inline; for Smart Printer; 1500 pieces on roll; stretchable 5 - 5.2 mm; plain; snap-on type; light green

www.wago.com/2009-115/000-017



Item no.: 2009-115/000-023

WMB-Inline; for Smart Printer; 1500 pieces on roll; stretchable 5 - 5.2 mm; plain; snap-on type; green

www.wago.com/2009-115/000-023



Item no.: 2009-115/000-024

WMB-Inline; for Smart Printer; 1500 pieces on roll; stretchable 5 - 5.2 mm; plain; snap-on type; violet

www.wago.com/2009-115/000-024



Item no.: 2009-145/000-006

Mini-WSB Inline; for Smart Printer; 1700 pieces on roll; stretchable 5 - 5.2 mm; plain; snap-on type; blue

www.wago.com/2009-145/000-006



Item no.: 2009-145

Mini-WSB Inline; for Smart Printer; 1700 pieces on roll; stretchable 5 - 5.2 mm; plain; snap-on type; white

www.wago.com/2009-145



Item no.: 2009-145/000-002

Mini-WSB Inline; for Smart Printer; 1700 pieces on roll; stretchable 5 - 5.2 mm; plain; snap-on type; yellow

www.wago.com/2009-145/000-002

Subject to changes. Please also observe the further product documentation!

WAGO GmbH & Co. KG

Hansastr. 27













32423 Minden

Phone: +49571 887-0 | Fax: +49571 887-169

Email: info.de@wago.com | Web: www.wago.com

Do you have any questions about our products?

We are always happy to take your call at +49 (571) 887-44222.

	Item no.: 2009-145/000-007 Mini-WSB Inline; for Smart Printer; 1700 pieces on roll; stretchable 5 - 5.2 mm; plain; snap-on type; gray	www.wago.com/2009-145/000-007
	Item no.: 2009-145/000-005 Mini-WSB Inline; for Smart Printer; 1700 pieces on roll; stretchable 5 - 5.2 mm; plain; snap-on type; red	www.wago.com/2009-145/000-005
	Item no.: 2009-145/000-012 Mini-WSB Inline; for Smart Printer; 1700 pieces on roll; stretchable 5 - 5.2 mm; plain; snap-on type; orange	www.wago.com/2009-145/000-012
	Item no.: 2009-145/000-023 Mini-WSB Inline; for Smart Printer; 1700 pieces on roll; stretchable 5 - 5.2 mm; plain; snap-on type; green	www.wago.com/2009-145/000-023
	Item no.: 2009-145/000-024 Mini-WSB Inline; for Smart Printer; 1700 pieces on roll; stretchable 5 - 5.2 mm; plain; snap-on type; violet	www.wago.com/2009-145/000-024
	Item no.: 2009-115 WMB-Inline; for Smart Printer; 1500 pieces on roll; stretchable 5 - 5.2 mm; plain; snap-on type; white	www.wago.com/2009-115
	Item no.: 248-501/000-006 Mini-WSB marking card; as card; not stretchable; plain; snap-on type; blue	www.wago.com/248-501/000-006
	Item no.: 248-501/000-007 Mini-WSB marking card; as card; not stretchable; plain; snap-on type; gray	www.wago.com/248-501/000-007
	Item no.: 248-501/000-002 Mini-WSB marking card; as card; not stretchable; plain; snap-on type; yellow	www.wago.com/248-501/000-002
	Item no.: 248-501/000-012 Mini-WSB marking card; as card; not stretchable; plain; snap-on type; orange	www.wago.com/248-501/000-012
	Item no.: 248-501 Mini-WSB marking card; as card; not stretchable; plain; snap-on type; white	www.wago.com/248-501
	Item no.: 248-501/000-017 Mini-WSB marking card; as card; not stretchable; plain; snap-on type; light green	www.wago.com/248-501/000-017

Subject to changes. Please also observe the further product documentation!



Item no.: 248-501/000-005
Mini-WSB marking card; as card; not stretchable; plain; snap-on type; red

www.wago.com/248-501/000-005



Item no.: 248-501/000-024
Mini-WSB marking card; as card; not stretchable; plain; snap-on type; violet

www.wago.com/248-501/000-024



Item no.: 248-501/000-023
Mini-WSB marking card; as card; not stretchable; plain; snap-on type; green

www.wago.com/248-501/000-023



Item no.: 793-5501/000-007
WMB marking card; as card; for terminal block width 5 - 17.5 mm; stretchable 5 - 5.2 mm; plain; snap-on type; gray

www.wago.com/793-5501/000-007



Item no.: 793-5501/000-012
WMB marking card; as card; for terminal block width 5 - 17.5 mm; stretchable 5 - 5.2 mm; plain; snap-on type; orange

www.wago.com/793-5501/000-012



Item no.: 793-5501/000-017
WMB marking card; as card; for terminal block width 5 - 17.5 mm; stretchable 5 - 5.2 mm; plain; snap-on type; light green

www.wago.com/793-5501/000-017



Item no.: 793-5501/000-023
WMB marking card; as card; for terminal block width 5 - 17.5 mm; stretchable 5 - 5.2 mm; plain; snap-on type; green

www.wago.com/793-5501/000-023



Item no.: 793-5501/000-024
WMB marking card; as card; for terminal block width 5 - 17.5 mm; stretchable 5 - 5.2 mm; plain; snap-on type; violet

www.wago.com/793-5501/000-024



Item no.: 793-501/000-002
WMB marking card; as card; not stretchable; plain; snap-on type; yellow

www.wago.com/793-501/000-002



Item no.: 793-501/000-007
WMB marking card; as card; not stretchable; plain; snap-on type; gray

www.wago.com/793-501/000-007

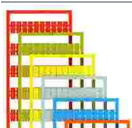

Item no.: 793-501/000-017
WMB marking card; as card; not stretchable; plain; snap-on type; light green

www.wago.com/793-501/000-017

Subject to changes. Please also observe the further product documentation!



Item no.: 793-501/000-012
WMB marking card; as card; not stretchable; plain; snap-on type; orange

www.wago.com/793-501/000-012



Item no.: 793-501/000-023
WMB marking card; as card; not stretchable; plain; snap-on type; green

www.wago.com/793-501/000-023



Item no.: 793-501/000-006
WMB marking card; as card; not stretchable; plain; snap-on type; blue

www.wago.com/793-501/000-006



Item no.: 793-501/000-005
WMB marking card; as card; not stretchable; plain; snap-on type; red

www.wago.com/793-501/000-005



Item no.: 793-501
WMB marking card; as card; not stretchable; plain; snap-on type; white

www.wago.com/793-501



Item no.: 793-501/000-024
WMB marking card; as card; not stretchable; plain; snap-on type; violet

www.wago.com/793-501/000-024



Item no.: 793-5501/000-005
WMB marking card; as card; for terminal block width 5 - 17.5 mm; stretchable 5 - 5.2 mm; plain; snap-on type; red

www.wago.com/793-5501/000-005



Item no.: 793-5501/000-002
WMB marking card; as card; for terminal block width 5 - 17.5 mm; stretchable 5 - 5.2 mm; plain; snap-on type; yellow

www.wago.com/793-5501/000-002



Item no.: 793-5501/000-006
WMB marking card; as card; for terminal block width 5 - 17.5 mm; stretchable 5 - 5.2 mm; plain; snap-on type; blue

www.wago.com/793-5501/000-006



Item no.: 793-5501
WMB marking card; as card; for terminal block width 5 - 17.5 mm; stretchable 5 - 5.2 mm; plain; snap-on type; white

www.wago.com/793-5501



Item no.: 2009-115/000-012
WMB-Inline; for Smart Printer; 1500 pieces on roll; stretchable 5 - 5.2 mm; plain; snap-on type; orange

www.wago.com/2009-115/000-012

Subject to changes. Please also observe the further product documentation!



Item no.: 2009-115/000-006

WMB-Inline; for Smart Printer; 1500 pieces on roll; stretchable 5 - 5.2 mm; plain; snap-on type; blue

www.wago.com/2009-115/000-006

Group marker carrier



Item no.: 2009-193

Group marker carrier; gray

www.wago.com/2009-193



Item no.: 2009-192

Group marker carrier; gray

www.wago.com/2009-192



Item no.: 2009-191

Group marker carrier; gray

www.wago.com/2009-191

Testing and measuring

Testing accessories



Item no.: 2009-174

Test plug adapter; for 4 mm Ø test plugs; for testing TOPJOB®S rail-mounted terminal blocks; gray

www.wago.com/2009-174



Item no.: 2009-182

Testing tap; for max. 2.5 mm²; tool-free connection for individual test wires 0.08 - 2.5 mm; gray

www.wago.com/2009-182



Item no.: 2016-511

Modular TOPJOB®S connector; modular; for jumper contact slot; 1-pole; 4,00 mm²; gray

www.wago.com/2016-511



Item no.: 2016-549

Spacer module; modular; e.g., for bridging commoned terminal blocks; gray

www.wago.com/2016-549



Item no.: 210-136

Test plug; 2 mm Ø; with 500 mm cable; red

www.wago.com/210-136

Tool

Operating tool



Item no.: 210-721

Operating tool; Blade: 5.5 x 0.8 mm; with a partially insulated shaft; multicoloured

www.wago.com/210-721

Jumpers

Jumper

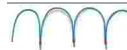

Item no.: 210-123

Wire commoning chain; insulated; blue

www.wago.com/210-123



Item no.: 2016-402

Jumper; 2-way; insulated; light gray

www.wago.com/2016-402



Item no.: 2016-405/011-000

Star point jumper; 3-way; insulated; light gray

www.wago.com/2016-405/011-000

Subject to changes. Please also observe the further product documentation!

WAGO GmbH & Co. KG

Hansastr. 27

32423 Minden

Phone: +49571 887-0 | Fax: +49571 887-169

Email: info.de@wago.com | Web: www.wago.com

Do you have any questions about our products?

We are always happy to take your call at +49 (571) 887-44222.

	Item no.: 2016-434 Jumper; from 1 to 4; insulated; light gray	www.wago.com/2016-434
	Item no.: 2016-404 Jumper; 4-way; insulated; light gray	www.wago.com/2016-404
	Item no.: 2016-405 Jumper; 5-way; insulated; light gray	www.wago.com/2016-405
	Item no.: 2016-435 Jumper; from 1 to 5; insulated; light gray	www.wago.com/2016-435
	Item no.: 2016-403 Jumper; 3-way; insulated; light gray	www.wago.com/2016-403
	Item no.: 2016-433 Jumper; from 1 to 3; insulated; light gray	www.wago.com/2016-433

Cover

Cover



Item no.: 2016-100
Finger guard; touchproof cover protects unused conductor entries; yellow

www.wago.com/2016-100

Ferrule

Ferrule



Item no.: 216-210
Ferrule; Sleeve for 16 mm² / AWG 6; insulated; electro-tin plated; electrolytic copper; gastight crimped; acc. to DIN 46228, Part 4/09.90; blue

www.wago.com/216-210



Item no.: 216-284
Ferrule; Sleeve for 1.5 mm² / AWG 16; insulated; electro-tin plated; electrolytic copper; gastight crimped; acc. to DIN 46228, Part 4/09.90; black

www.wago.com/216-284



Item no.: 216-286
Ferrule; Sleeve for 2.5 mm² / AWG 14; insulated; electro-tin plated; electrolytic copper; gastight crimped; acc. to DIN 46228, Part 4/09.90; blue

www.wago.com/216-286



Item no.: 216-287
Ferrule; Sleeve for 4 mm² / AWG 12; insulated; electro-tin plated; electrolytic copper; gastight crimped; acc. to DIN 46228, Part 4/09.90; gray

www.wago.com/216-287



Item no.: 216-288
Ferrule; Sleeve for 6 mm² / AWG 10; insulated; electro-tin plated; electrolytic copper; gastight crimped; acc. to DIN 46228, Part 4/09.90; yellow

www.wago.com/216-288



Item no.: 216-289
Ferrule; Sleeve for 10 mm² / AWG 8; insulated; electro-tin plated; electrolytic copper; gastight crimped; acc. to DIN 46228, Part 4/09.90; red

www.wago.com/216-289

Mounting

Cover carrier

Subject to changes. Please also observe the further product documentation!



Item no.: 709-169
Cover carrier; Type 3; gray

Cover



Item no.: 709-156
Cover; Type 3; suitable for cover carrier, type 3; 1 m long; transparent

www.wago.com/709-156

Carrier rail

Mounting accessories



Item no.: 210-197
Steel carrier rail; 35 x 15 mm; 1.5 mm thick; 2 m long; slotted; similar to EN 60715; silver-colored

www.wago.com/210-197



Item no.: 210-198
Copper carrier rail; 35 x 15 mm; 2.3 mm thick; 2 m long; unslotted; according to EN 60715; copper-colored

www.wago.com/210-198



Item no.: 210-113
Steel carrier rail; 35 x 7.5 mm; 1 mm thick; 2 m long; unslotted; according to EN 60715; silver-colored

www.wago.com/210-113

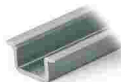

Item no.: 210-118
Steel carrier rail; 35 x 15 mm; 2.3 mm thick; 2 m long; unslotted; according to EN 60715; silver-colored

www.wago.com/210-118



Item no.: 210-112
Steel carrier rail; 35 x 7.5 mm; 1 mm thick; 2 m long; slotted; according to EN 60715; "Hole width 25 mm; silver-colored" www.wago.com/210-112



Item no.: 210-114
Steel carrier rail; 35 x 15 mm; 1.5 mm thick; 2 m long; unslotted; similar to EN 60715; silver-colored

www.wago.com/210-114



Item no.: 210-115
Steel carrier rail; 35 x 7.5 mm; 1 mm thick; 2 m long; slotted; according to EN 60715; "Hole width 18 mm; silver-colored" www.wago.com/210-115



Item no.: 210-196
Aluminum carrier rail; 35 x 8.2 mm; 1.6 mm thick; 2 m long; unslotted; similar to EN 60715; silver-colored

www.wago.com/210-196

Downloads

Documentation

Bid Text

2116-5207 X81 - Datei	2019 Apr 15	xml 3.9 kB	Download
2116-5207 docx - Datei	2019 Apr 15	docx 14.8 kB	Download

Subject to changes. Please also observe the further product documentation!

Additional Information

Technical Section	pdf	Download
Technical explanations	2.2 MB	

CAD/CAE-Data

CAD data

2D/3D Models 2116-5207	URL	Download
------------------------	-----	----------

CAE data

EPLAN Data Portal 2116-5207	URL	Download
-----------------------------	-----	----------

ZUKEN Portal 2116-5207	URL	Download
------------------------	-----	----------

Environmental Product Compliance

Compliance Search

Environmental Product Compliance 2116-5207	URL	Download
--	-----	----------

2-conductor ground terminal block; with lever and push-button; 16 mm²; with test port; side and center marking; for DIN-rail 35 x 15 and 35 x 7.5; Push-in CAGE CLAMP®; 16,00 mm²; green-yellow

Installation Notes

Conductor termination

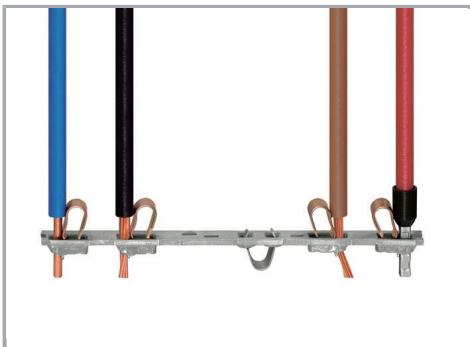

All conductor types at a glance

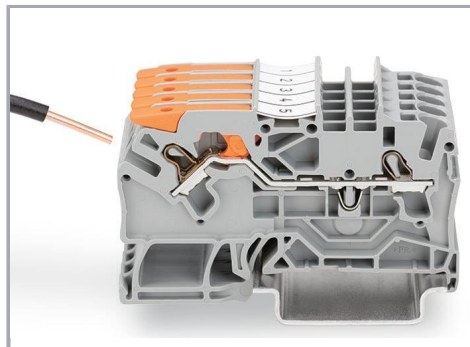

Push-in termination of solid conductors

Subject to changes. Please also observe the further product documentation!

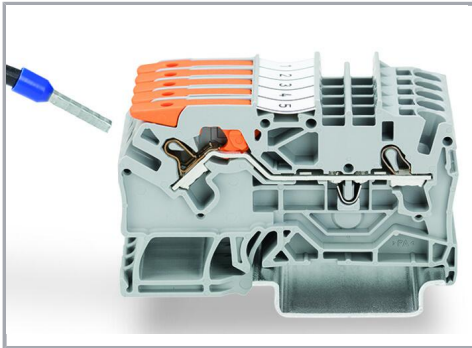

Push-in termination of fine-stranded conductors with ferrules

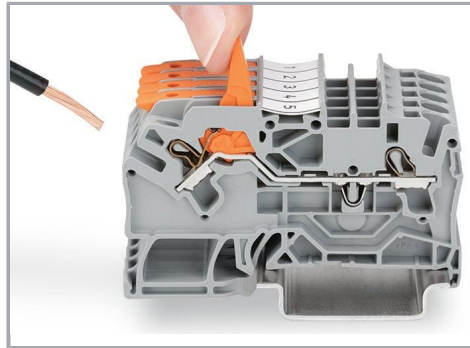

Pull the lever up until it stops, then connect the fine-stranded conductor.

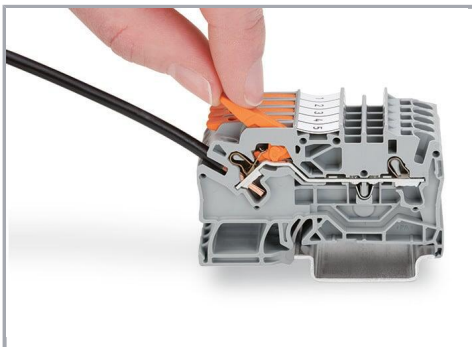

Push the lever back down – done!

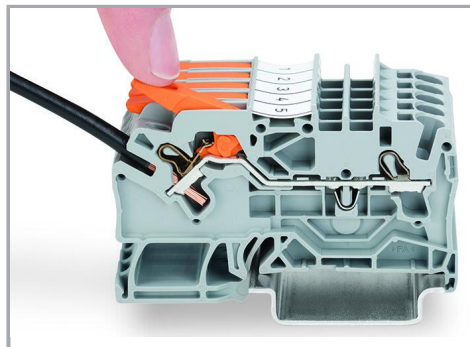

Push the lever back down – done!

Commoning



Insert a push-in type jumper bar and push down until it hits the backstop.

Marking

Subject to changes. Please also observe the further product documentation!

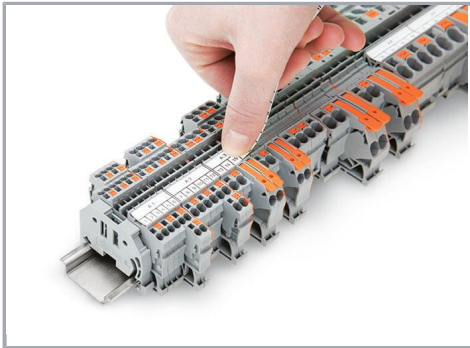

Snapping a marking strip into a marker slot.

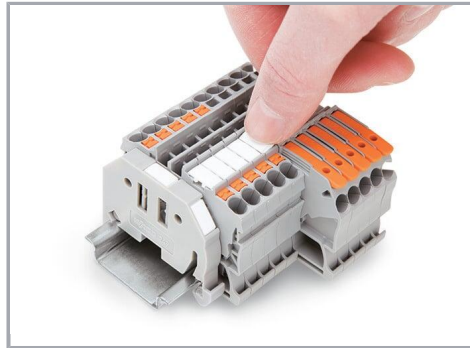

Snapping a marking strip into the marker slot.

Product family

TOPJOB® S

TOPJOB® S: In various industrial applications and modern building installations, WAGO's wide and versatile range of rail-mount terminal blocks provides more than just reliable electrical connections.

[Show all products from the family](#)

Subject to changes. Please also observe the further product documentation!