

PCB LAYOUT - COMPONENT VIEW

TECHNICAL CHARACTERISTICS

MATERIAL  
 INSULATOR MATERIAL: PBT  
 FLAMMABILITY RATING: UL94-V0  
 COLOR: BLACK  
 CONTACT MATERIAL: COPPER ALLOY  
 CONTACT TYPE: STAMPED  
 CONTACT PLATING: GOLD  
 QUALITY CLASS: 500 MATING CYCLES

ENVIRONMENTAL  
 OPERATING TEMPERATURE: -25 °C UP TO 85 °C  
 COMPLIANCE: LEAD FREE AND ROHS

ELECTRICAL  
 CURRENT RATING: 1.5 A  
 WORKING VOLTAGE: 120 VAC  
 INSULATION RESISTANCE: >500 MΩ  
 DIELECTRIC WITHSTANDING VOLTAGE: 1 000 VAC/MIN  
 CONTACT RESISTANCE: 20 mΩ MAX

STANDARD

CERTIFIED: E324776

SOLDERING  
 JEDEC LEAD FREE WAVE SOLDERING PROCESS

PACKAGING  
 TRAY

A

B

C

RoHS Compliant			
G			
F			
E			
D	03-JAN-14	TPK DWG ADD	QL
C	21-JAN-13	PAD SHAPE + DIM	QL
B	07-OCT-09	NO SHIELD & UL STD	JP
A	06-NOV-08	PDF	CH
REV	DATE	FILE	BY

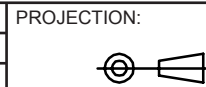

GENERAL TOLERANCE  
 .X = +/- 0.2  
 .XX = +/- 0.15



APPROVAL: RJ

UNIT: MM
SCALE:
SHEET: 1/1
DRAW:

DESCRIPTION: VERTICAL PLASTIC 8P8C MODULAR JACK WITH EARS	SIZE <b>A4</b>
WERI PART NO: 615 008 144 221	

D

1

2

3

4

5

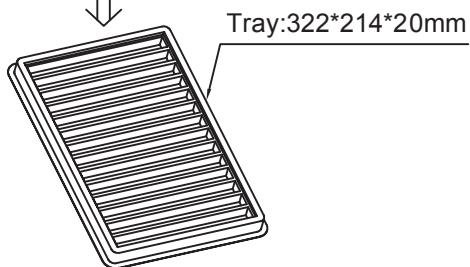
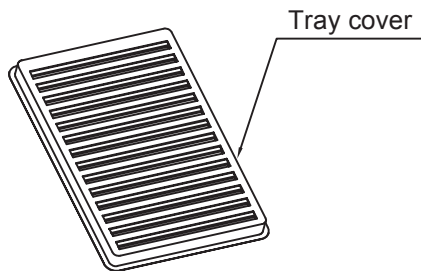

Partition:45\*34CM  
Top and bottom of pile are placed with 1 partition

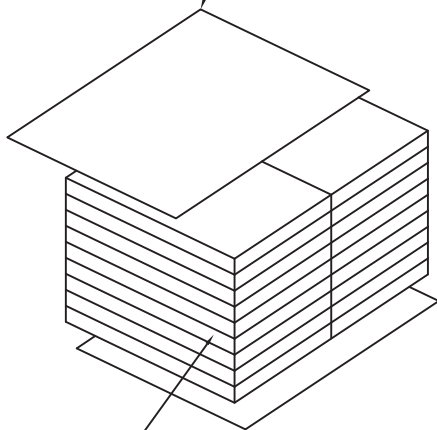

18 trays per carton  
9 trays/pile

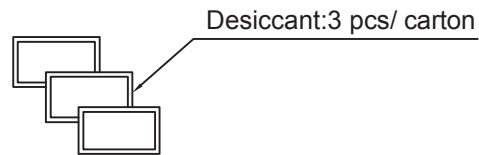

Waterproof Bag:45\*35\*57cm  
1pc/carton

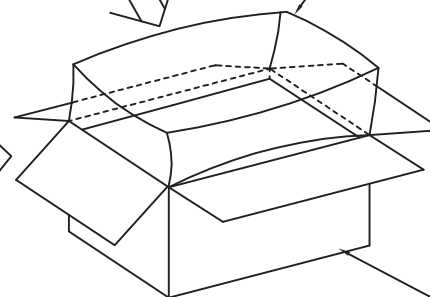

Carton size:48\*36\*22cm

### Packaging Qty

154 pcs/tray	18 trays/carton	2772 pcs/carton
--------------	-----------------	-----------------

RoHS Compliant			
G			
F			
E			
D			
C			
B			
A			
REV	DATE	FILE	BY

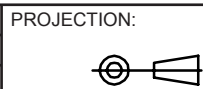

GENERAL TOLERANCE  
.X = +/- 0.2  
.XX = +/- 0.15



APPROVAL: RJ

UNIT: MM  
SCALE:  
SHEET: 1/1  
DRAW:

DESCRIPTION: VERTICAL PLASTIC 8P8C MODULAR JACK WITH EARS  
WERI PART NO: 615 008 144 221

SIZE  
**A4**

A

B

C

D