

Contact Dimensions:
558-90 Degree Bend (Code 541 Contacts)
 See Sheet 2 for Contact Code 555, 556, 558, 559, 560 Dimensions

THIS IS A C.A.D. GENERATED DRAWING
 DO NOT MAKE MANUAL REVISIONS TO MASTER



ISSUE NUMBER

ORIGINAL

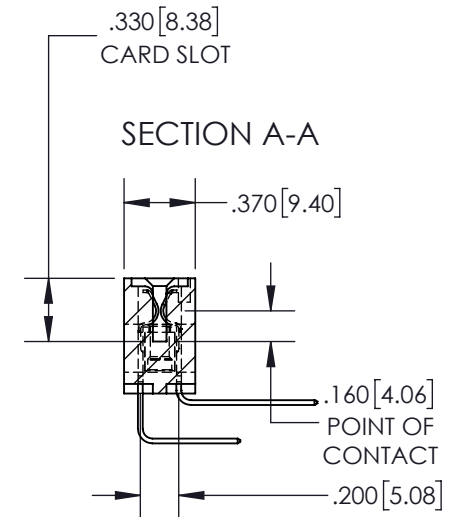
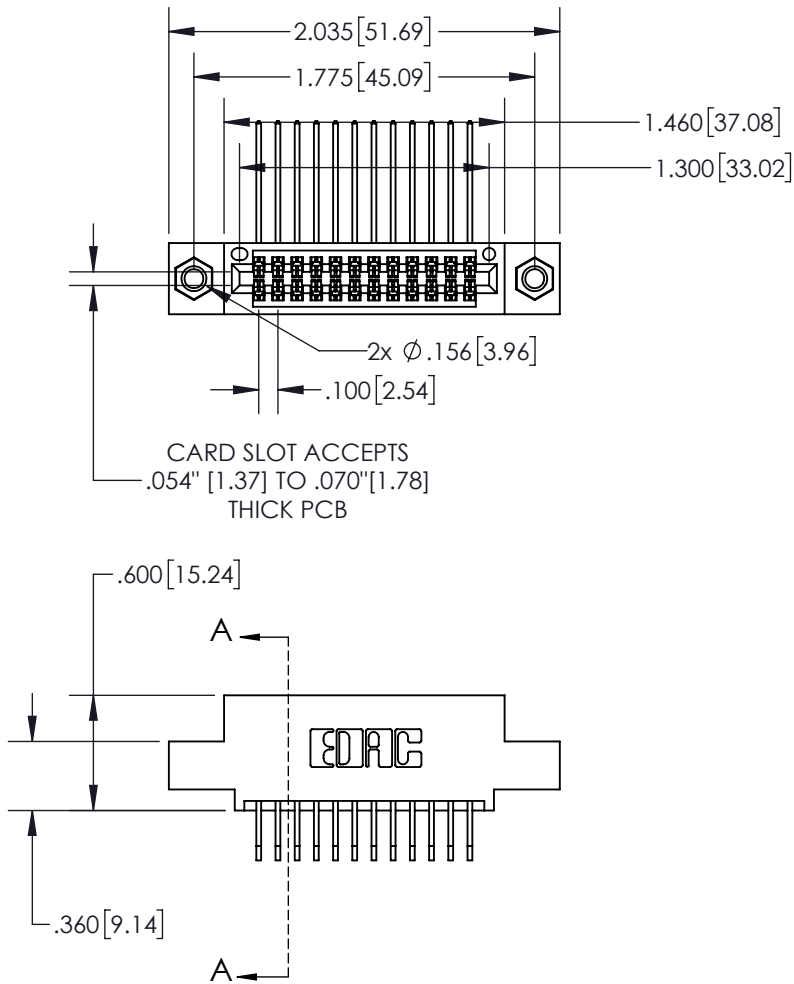

- INSULATOR MATERIAL: THERMOPLASTIC, UL 94V-0
- CONTACT MATERIAL: COPPER TIN ALLOY
- CONTACT PLATING: GOLD ON THE MATING AREA, TIN PLATING ON THE CONTACT TAILS, NICKEL UNDERPLATE

845/895 SERIES HIGH TEMP CARD EDGE CONNECTOR
PART NUMBER: 895-024-558-507



YOUR CONNECTION TO QUALITY & SERVICE

EDAC INC
 TORONTO, ONTARIO
 CANADA

THESE DRAWINGS AND SPECIFICATIONS
 ARE THE PROPERTY OF EDAC INC. AND
 SHALL NOT BE REPRODUCED, OR COPIED
 OR USED AS THE BASIS FOR THE
 MANUFACTURE OR SALE OF APPARATUS
 WITHOUT WRITTEN PERMISSION.

ACAD REFERENCE NO. 845-ENG-MASTER

DRAWN: R.STA.MONICA DATE: MAY.16/2017

CHECKED: DATE:

SCALE: 1:1 SHEET 1 OF 2

DRAWING NUMBER ISSUE

845-ENG-MASTER

1

THIS IS A C.A.D. GENERATED DRAWING
DO NOT MAKE MANUAL REVISIONS TO MASTER.



ISSUE NUMBER
ORIGINAL



Contact Code 555



Contact Code 556



Contact Code 558



Contact Code 559



Contact Code 560

- INSULATOR MATERIAL: THERMOPLASTIC POLYESTER, UL 94V-0
- DAP MATERIAL AVAILABLE UPON REQUEST
- CONTACT MATERIAL: COPPER ALLOY
- CONTACT PLATING: GOLD ON THE MATING AREA, TIN PLATING ON THE CONTACT TAILS, NICKEL UNDERPLATE

**845/895 SERIES HIGH TEMP CARD EDGE CONNECTOR
CONTACT CODE 555,556,558,559,560 DIMENSIONS**



THESE DRAWINGS AND SPECIFICATIONS ARE THE PROPERTY OF EDAC INC. AND SHALL NOT BE REPRODUCED, OR COPIED OR USED AS THE BASIS FOR THE MANUFACTURE OR SALE OF APPARATUS WITHOUT WRITTEN PERMISSION.

ACAD REFERENCE NO. 845-ENG-MASTER	
DRAWN: R.STA.MONICA	DATE: MAY.16/2017
CHECKED:	DATE:
SCALE: 1:1	SHEET 2 OF 2
DRAWING NUMBER 845-ENG-MASTER	ISSUE 1