

MATED PROFILE
(SHOWN MATED TO VERTICAL RECEPTACLE ASSY)

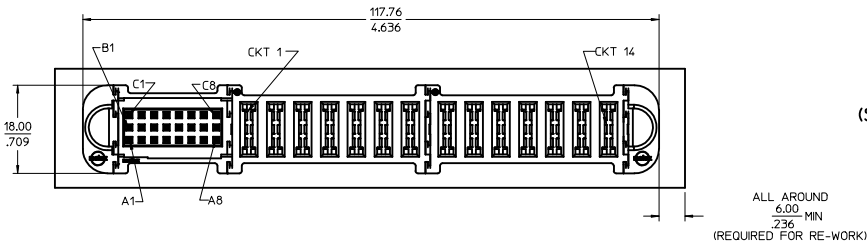

ALL AROUND
6.00
2.36 MIN
(REQUIRED FOR RE-WORK)

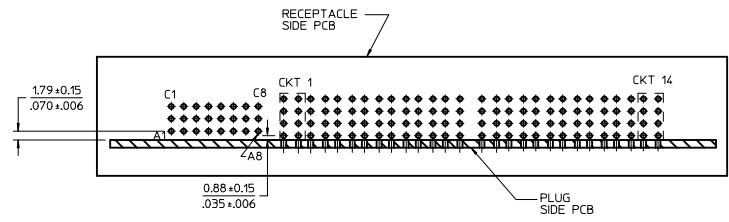

SECTION Z-Z

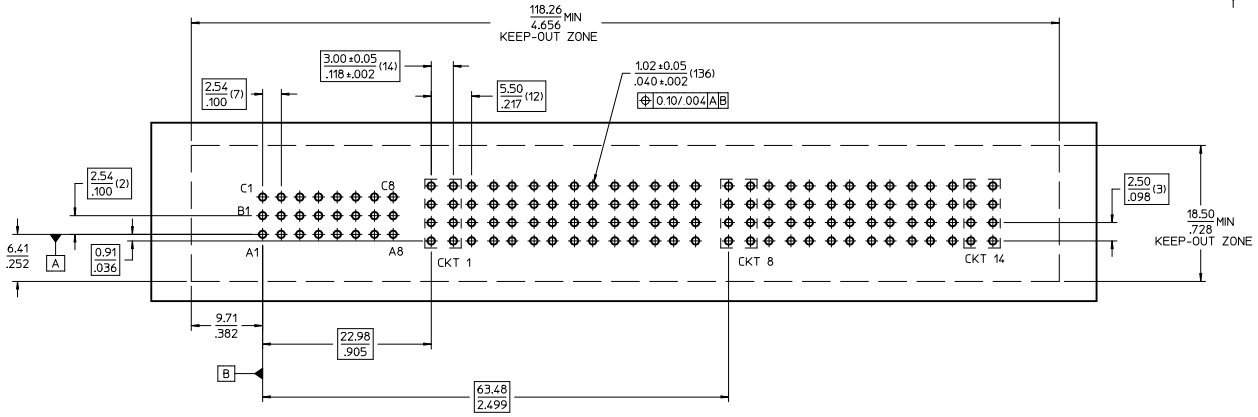

RECOMMENDED PCB LAYOUT
AND KEEP-OUT ZONE

NOTES:

- MATERIAL:
-HOUSINGS: LCP UL-94, V-0, COLOR: BLACK
-TERMINALS: COPPER ALLOY
-PLATING: .00127 NICKEL OVERALL WITH 0.00254 SELECTIVE TIN ON COMPLIANT PINS.
AND 0.000762 SELECTIVE GOLD ON CONTACT AREA.
- PACKAGING: ASSEMBLIES TO BE TRAY PACKED, QTY TBD.
- PRODUCT SPEC: PS-46436-100.
- APPLICATION SPEC: AS-46436-100.
- PC BOARD REQUIRES THRU HOLES, REFER TO PS-46436-100 FOR DETAILS.
- SEE PRODUCT SPEC FOR RoHS REQUIREMENTS.
- ASSEMBLY MATES TO MOLEX PLUG ASSEMBLY P/N: 46437-1094.

RELEASED IEC NO: UICP2010-2173 DRAWN BY: MKARADIMAS 2009/10/06 CHECKED BY: CHYKBKOSTIC 2010/03/09 APPROVED BY: APPR:APATEL 2010/03/31	QUALITY SYMBOLS	GENERAL TOLERANCES (UNLESS SPECIFIED)	DIMENSION STYLE	SCALE	DESIGN UNITS	THIRD ANGLE PROJECTION
	▽=0	mm INCH	MM/IN	2:1	METRIC	☉
	▽=0	4 PLACES ± .010	DRAWN BY: MKARADIMAS 2009/10/06	DATE: 2009/10/06	TITLE: VERT. RECEPTACLE ASSY 7PWR-7PWR 24 SIGNAL CKT PRESS-FIT, TEN60 FAMILY	
	▽=0	3 PLACES ± .025	CHECKED BY: BKOSTIC 2009/10/06	DATE: 2009/10/06	MATERIAL NO. 46562-1094	
	1 PLACE ± .025	APPROVED BY: JCOMERCI 2010/03/01	DATE: 2010/03/01	DOCUMENT NO. SD-46562-1094		SHEET NO. 1 OF 1
DRAFT WHERE APPLICABLE MUST REMAIN WITHIN DIMENSIONS		THIS DRAWING CONTAINS INFORMATION THAT IS PROPRIETARY TO MOLEX INCORPORATED AND SHOULD NOT BE USED WITHOUT WRITTEN PERMISSION				

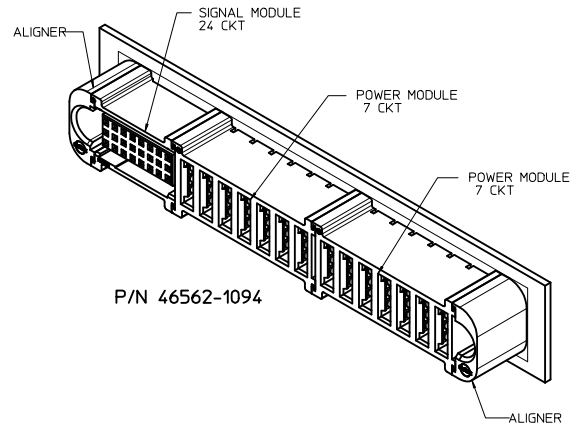
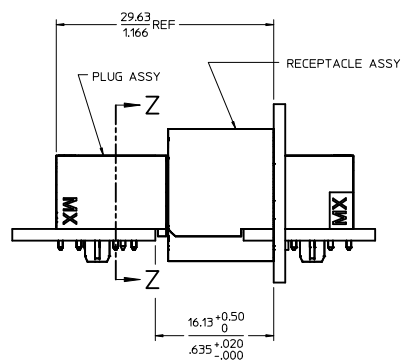
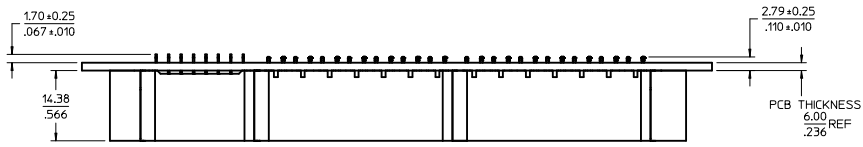

MATED PROFILE
(SHOWN MATED TO VERTICAL RECEPTACLE ASSY)

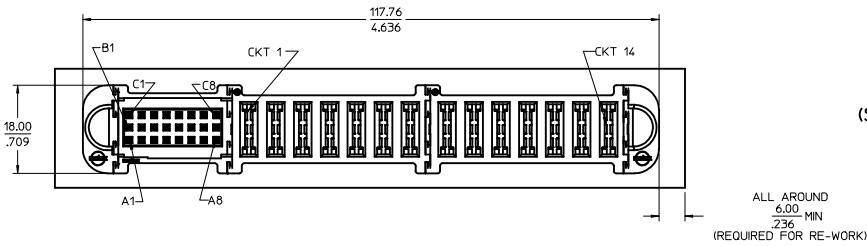

ALL AROUND
6.00
2.36 MIN
(REQUIRED FOR RE-WORK)

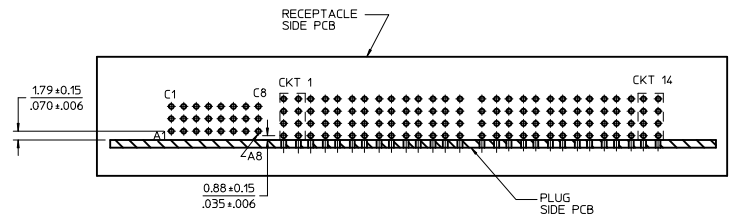

SECTION Z-Z

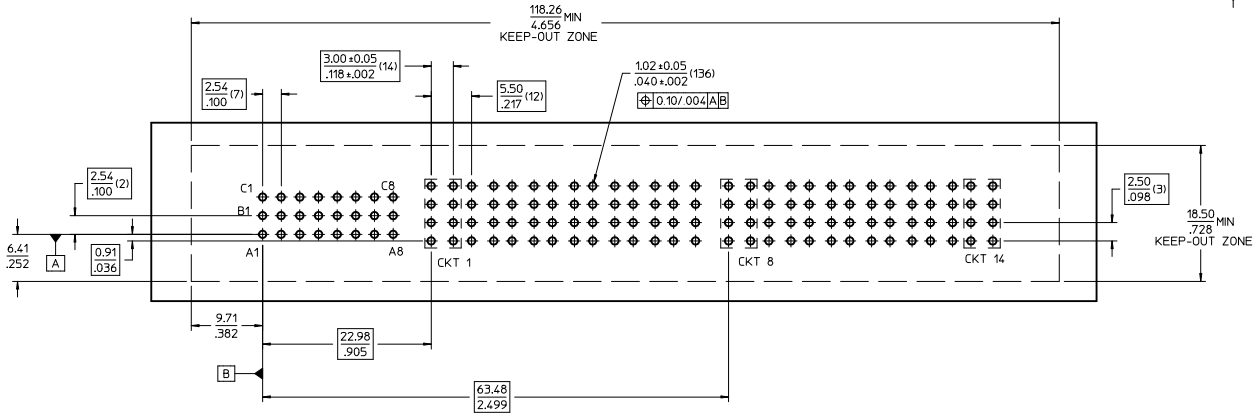

RECOMMENDED PCB LAYOUT
AND KEEP-OUT ZONE

NOTES:

- MATERIAL:
-HOUSINGS: LCP UL-94, V-0, COLOR: BLACK
-TERMINALS: COPPER ALLOY
-PLATING: .00127 NICKEL OVERALL WITH 0.00254 SELECTIVE TIN ON COMPLIANT PINS.
AND 0.000762 SELECTIVE GOLD ON CONTACT AREA.
- PACKAGING: ASSEMBLIES TO BE TRAY PACKED, QTY TBD.
- PRODUCT SPEC: PS-46436-100.
- APPLICATION SPEC: AS-46436-100.
- PC BOARD REQUIRES THRU HOLES, REFER TO PS-46436-100 FOR DETAILS.
- SEE PRODUCT SPEC FOR RoHS REQUIREMENTS.
- ASSEMBLY MATES TO MOLEX PLUG ASSEMBLY P/N: 46437-1094.

RELEASED IEC NO: UICP2010-2173 DRAWN BY: MKARADIMAS 2009/10/06 CHECKED BY: CHYKROSTIC 2010/03/09 APPROVED BY: APPR:APATEL 2010/03/31	QUALITY SYMBOLS	GENERAL TOLERANCES (UNLESS SPECIFIED)	DIMENSION STYLE	SCALE	DESIGN UNITS	THIRD ANGLE PROJECTION
	▽=0	mm INCH	MM/IN	2:1	METRIC	☉
	▽=0	4 PLACES ± .010	DRAWN BY: MKARADIMAS 2009/10/06	DATE: 2009/10/06	TITLE: VERT. RECEPTACLE ASSY	
	▽=0	3 PLACES ± .025	CHECKED BY: BKOSTIC 2009/10/06	DATE: 2009/10/06	7PWR-7PWR 24 SIGNAL CKT	
	ANGULAR ±1/2°	1 PLACE ± .025	APPROVED BY: JCOMERCI 2010/03/01	DATE: 2010/03/01	PRESS-FIT, TEN60 FAMILY	
	DRAFT WHERE APPLICABLE MUST REMAIN WITHIN DIMENSIONS		MATERIAL NO: 46562-1094	DOCUMENT NO: SD-46562-1094	MOLEX INCORPORATED	
			SIZE: D	THIS DRAWING CONTAINS INFORMATION THAT IS PROPRIETARY TO MOLEX INCORPORATED AND SHOULD NOT BE USED WITHOUT WRITTEN PERMISSION		SHEET NO: 1 OF 1