

MATED VIEW
10-WAFER CONNECTOR SHOWN

NOTES:

- MATERIALS:
RETAINER HOUSING/WAFER PLASTIC - LIQUID CRYSTAL POLYMER (LCP),
GLASS FILLED, UL94 V-0. COLOR: BLACK (30µin Au) OR GRAY (50µin Au)
TERMINALS - HIGH PERFORMANCE COPPER ALLOY
- FINISHES:
TERMINAL - SELECTIVE GOLD (Au) IN CONTACT AREA,
SELECTIVE MATTE TIN (Sn) ON PCB TAILS,
NICKEL (Ni) UNDERPLATE OVERALL
- PRODUCT SPECIFICATION: PS-74031-999
- PACKAGING SPECIFICATION: PK-70873-0750
- MATES WITH VHDM 8-ROW BACKPLANE HEADER SERIES NO. 74060
- THESE PARTS CONFORM TO MOLEX COSMETIC SPECIFICATION PS-45499-002 CLASS B.

MATERIAL NUMBER ASSIGNMENT

75117 - * * * *

GOLD THICKNESS/TAIL PLATING

- 0 = 30µm / MATTE TIN (FORMERLY TIN/LEAD)
- 1 = 50µm / MATTE TIN (FORMERLY TIN/LEAD)
- 7 = 10µm/MATTE TIN (MAPS)
- 8 = 50µm/MATTE TIN
- 9 = 30µm/MATTE TIN

STACK HEIGHT
DIM "H"
18 = 18mm
* 28 = 28mm

* CONSULT FACTORY FOR AVAILABILITY
NUMBER OF WAFERS
0 = 50
1 = 10
2 = 25

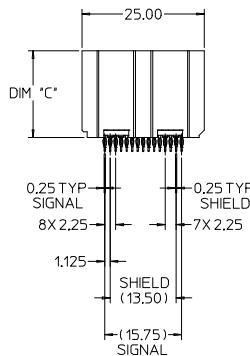
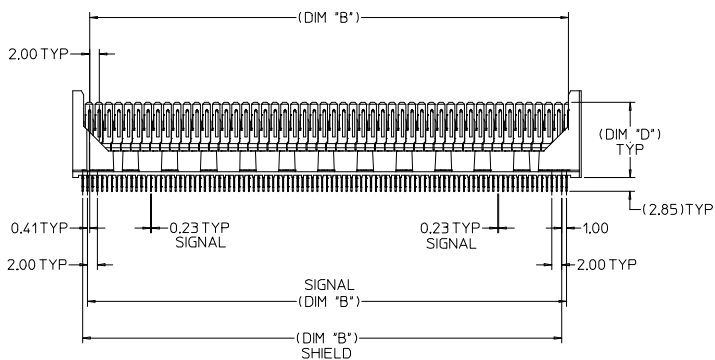

LEAD FREE
PLATING

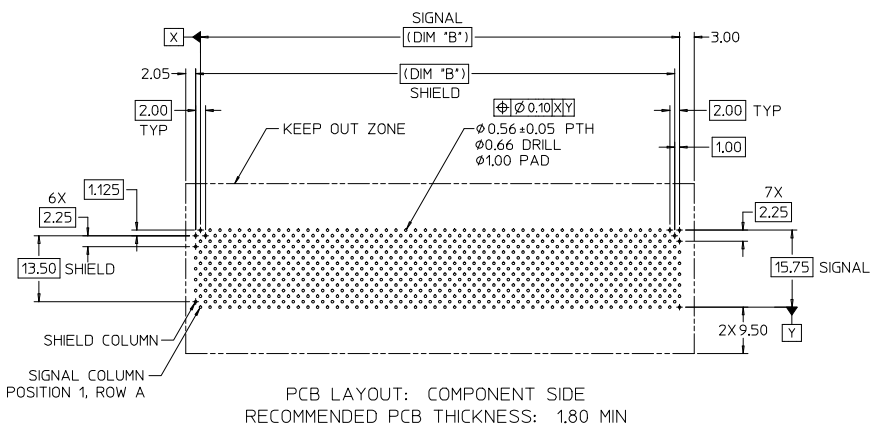

MATERIAL NUMBER	NUMBER OF WAFERS	DIM 'A'	DIM 'B'	DIM 'C'	DIM 'D'	DIM 'H' STACK HEIGHT
*75117-*228	25	54.05	48.00	27.74	25.36	28
*75117-*128	10	24.05	18.00			
*75117-*028	50	104.05	98.00	17.74	15.36	18
75117-*218	25	54.05	48.00			
75117-*118	10	24.05	18.00			
75117-*018	50	104.05	98.00			

* CONSULT FACTORY FOR AVAILABILITY

L.F. CONVERSION /MAPS EC NO: UCP2013-3702 DRAWN BY: DRYNWRHPPLE CHECKED BY: CHYKHMOLEE APPROVED BY: APPRSHILLER DATE: 2013/02/07 DATE: 2014/02/05 DESCRIPTION:	QUALITY SYMBOLS	GENERAL TOLERANCES (UNLESS SPECIFIED)	DIMENSION STYLE	SCALE	DESIGN UNITS	THIRD ANGLE PROJECTION	
	▽=0	mm INCH	MM ONLY	2:1	METRIC		
	▽=0	4 PLACES ± --- ± ---	DRAWN BY: SREED	DATE: 2013/02/27	TITLE: VHDM 8-ROW DAUGHTERCARD STACKER CONNECTOR SALES DRAWING		
	▽=0	3 PLACES ± --- ± ---	CHECKED BY: JBI NINGHAM	DATE: 2013/02/27	molex		
	2 PLACES ± 0.13 ± ---	1 PLACE ± 0.25 ± ---	0 PLACE ± ±	APPROVED BY: CBI XLER	DATE: 2013/02/27		
	ANGULAR ± 2 °		MATERIAL NO. SEE CHART	DOCUMENT NO. SD-75117-001	SHEET NO. 1 OF 2		
DRAFT WHERE APPLICABLE MUST REMAIN WITHIN DIMENSIONS		THIS DRAWING CONTAINS INFORMATION THAT IS PROPRIETARY TO MOLEX INCORPORATED AND SHOULD NOT BE USED WITHOUT WRITTEN PERMISSION					

20 19 18 17 16 15 14 13 12 11 10 9 8 7 6 5 4 3 2 1

P/N 75117-*018

18mm STACK HEIGHT
50 WAFER

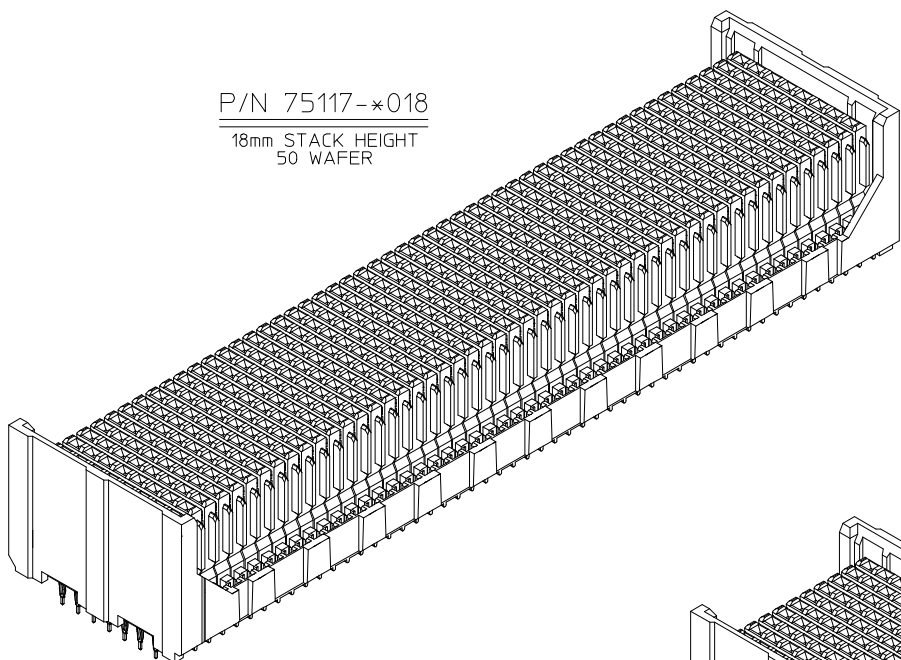

P/N 75117-*218

18mm STACK HEIGHT
25 WAFER

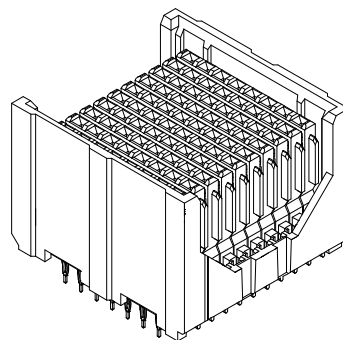
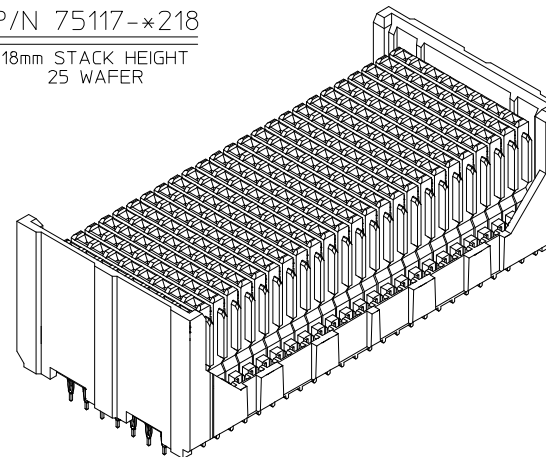

P/N 75117-*118

18mm STACK HEIGHT
10 WAFER

LEAD FREE CONVERSION IEC NO: UCP2013-3702 DRAWN BY: CHYKHOFFLE 2013/02/07 CHECKED BY: APPR:SMILLER 2014/02/05 DATE: 2014/02/05	QUALITY SYMBOLS	GENERAL TOLERANCES (UNLESS SPECIFIED)	DIMENSION STYLE	SCALE	DESIGN UNITS	THIRD ANGLE PROJECTION
	▽=0	4 PLACES ± mm ± INCH	MM ONLY	4:1	METRIC	
	▽=0	3 PLACES ± 0.13 ± ---				
	▽=0	2 PLACES ± 0.25 ± ---				
		ANGULAR ± 2 °	DRAWN BY: SREED 2003/02/27	DATE: 2003/02/27	TITLE: VHDM 8-ROW DAUGHTERCARD STACKER CONNECTOR SALES DRAWING	
		DRAFT WHERE APPLICABLE MUST REMAIN WITHIN DIMENSIONS	CHECKED BY: JB INGHAM 2003/02/27	DATE: 2003/02/27		
			APPROVED BY: CB IXLER 2003/02/27	DATE: 2003/02/27	MATERIAL NO. SEE CHART	DOCUMENT NO. SD-75117-001
						SHEET NO. 2 OF 2

19 18 17 16 15 14 13 12 11 10 9 8 7 6 5 4 3 2 1

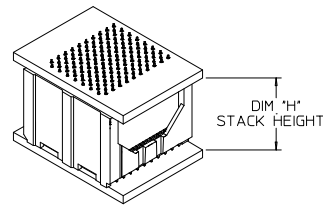
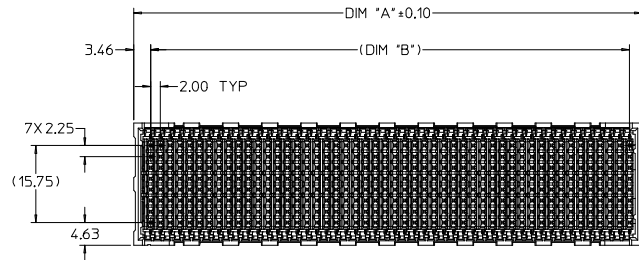

MATED VIEW
10-WAFER CONNECTOR SHOWN

NOTES:

- MATERIALS:
RETAINER HOUSING/WAFER PLASTIC - LIQUID CRYSTAL POLYMER (LCP),
GLASS FILLED, UL94 V-0. COLOR: BLACK (30µin Au) OR GRAY (50µin Au)
TERMINALS - HIGH PERFORMANCE COPPER ALLOY
- FINISHES:
TERMINAL - SELECTIVE GOLD (Au) IN CONTACT AREA,
SELECTIVE MATTE TIN (Sn) ON PCB TAILS,
NICKEL (Ni) UNDERPLATE OVERALL
- PRODUCT SPECIFICATION: PS-74031-999
- PACKAGING SPECIFICATION: PK-70873-0750
- MATES WITH VHDM 8-ROW BACKPLANE HEADER SERIES NO. 74060
- THESE PARTS CONFORM TO MOLEX COSMETIC SPECIFICATION PS-45499-002 CLASS B.

MATERIAL NUMBER ASSIGNMENT

75117 - * * * *

GOLD THICKNESS/TAIL PLATING

- 0 = 30µm / MATTE TIN (FORMERLY TIN/LEAD)
- 1 = 50µm / MATTE TIN (FORMERLY TIN/LEAD)
- 7 = 10µm/MATTE TIN (MAPS)
- 8 = 50µm/MATTE TIN
- 9 = 30µm/MATTE TIN

STACK HEIGHT
DIM "H"
18 = 18mm
* 28 = 28mm

* CONSULT FACTORY FOR AVAILABILITY
NUMBER OF WAFERS
0 = 50
1 = 10
2 = 25

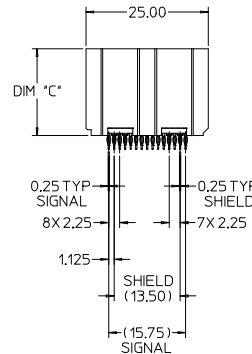
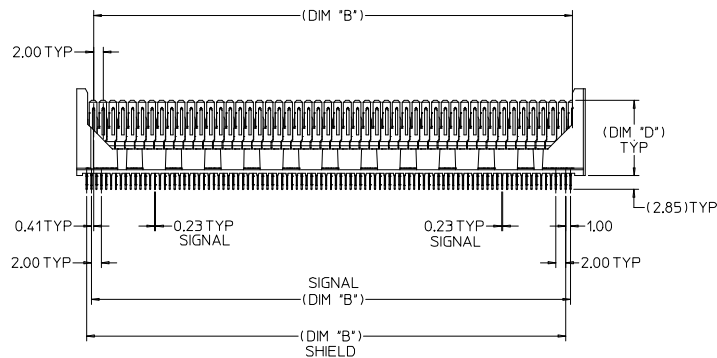

LEAD FREE
PLATING

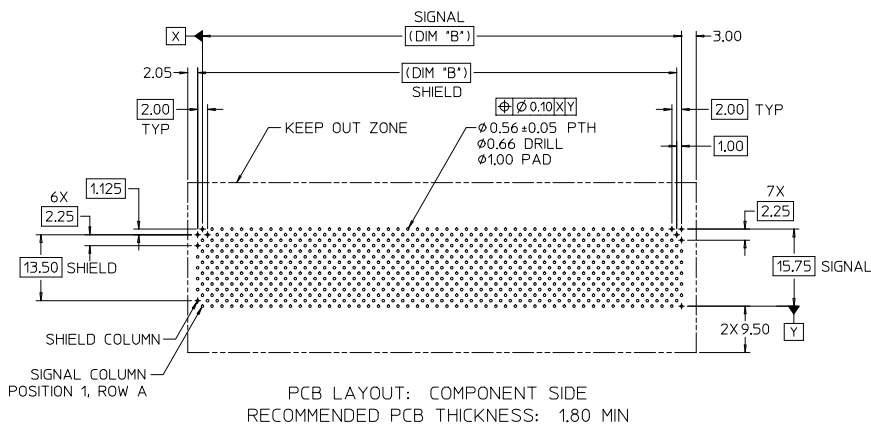

MATERIAL NUMBER	NUMBER OF WAFERS	DIM 'A'	DIM 'B'	DIM 'C'	DIM 'D'	DIM 'H' STACK HEIGHT
*75117-*228	25	54.05	48.00	27.74	25.36	28
*75117-*128	10	24.05	18.00			
*75117-*028	50	104.05	98.00	17.74	15.36	18
75117-*218	25	54.05	48.00			
75117-*118	10	24.05	18.00			
75117-*018	50	104.05	98.00			

* CONSULT FACTORY FOR AVAILABILITY

L.F. CONVERSION /MAPS EC NO: UCP2013-3702 DRAWN BY: DRYNARHPLE CHECKED BY: CHYKHOVLEE APPROVED BY: APPR:SMILLER 2013/02/07 2013/02/07 2014/02/05	QUALITY SYMBOLS	GENERAL TOLERANCES (UNLESS SPECIFIED)	DIMENSION STYLE	SCALE	DESIGN UNITS	THIRD ANGLE PROJECTION	
	▽=0	mm INCH	MM ONLY	2:1	METRIC		
	▽=0	4 PLACES ± --- ± ---	DRAWN BY: SREED	DATE: 2013/02/27	TITLE: VHDM 8-ROW DAUGHTERCARD STACKER CONNECTOR SALES DRAWING		
	▽=0	3 PLACES ± --- ± ---	CHECKED BY: JB INGHAM	DATE: 2013/02/27	molex		
	2 PLACES ± 0.13 ± ---	1 PLACE ± 0.25 ± ---	0 PLACE ± ±	APPROVED BY: CBI XLER	DATE: 2013/02/27		
	ANGULAR ± 2 °		MATERIAL NO. SEE CHART	DOCUMENT NO. SD-75117-001	SHEET NO. 1 OF 2		
DRAFT WHERE APPLICABLE MUST REMAIN WITHIN DIMENSIONS		THIS DRAWING CONTAINS INFORMATION THAT IS PROPRIETARY TO MOLEX INCORPORATED AND SHOULD NOT BE USED WITHOUT WRITTEN PERMISSION					

20 19 18 17 16 15 14 13 12 11 10 9 8 7 6 5 4 3 2 1

P/N 75117-*018
18mm STACK HEIGHT
50 WAFER

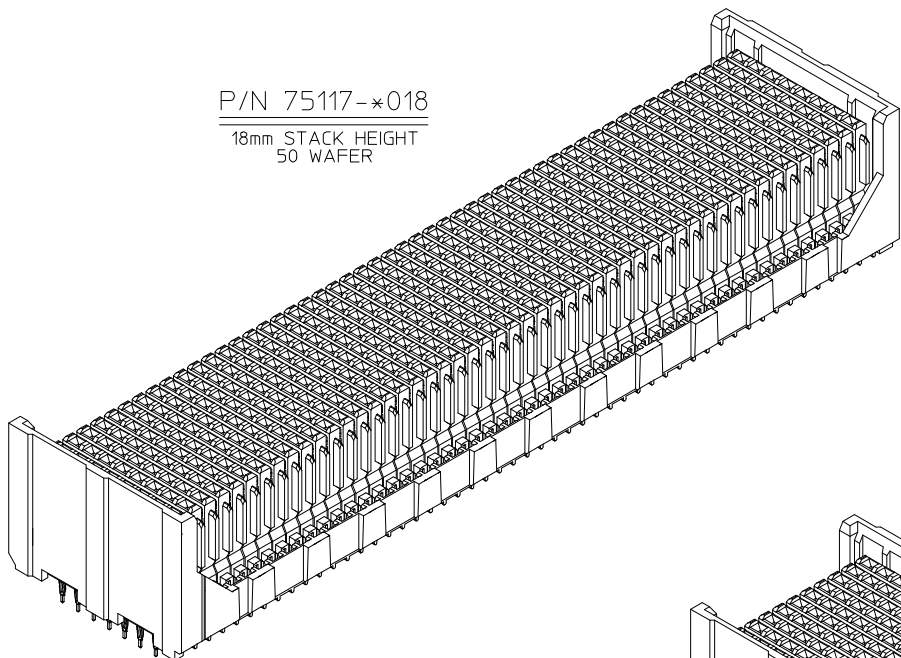

P/N 75117-*218
18mm STACK HEIGHT
25 WAFER

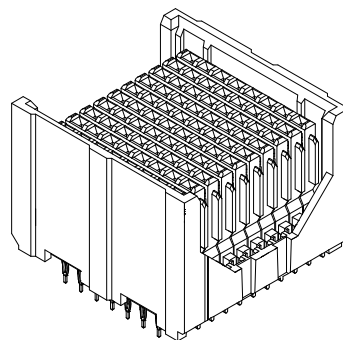
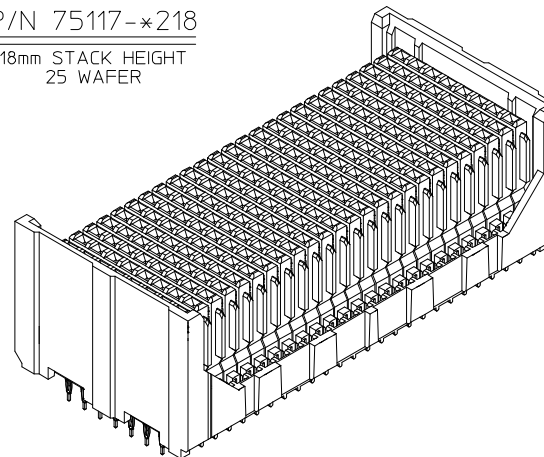

P/N 75117-*118
18mm STACK HEIGHT
10 WAFER

LEAD FREE CONVERSION IEC NO: UCP2013-3702 DRAWN BY: CHYKHOFFLE 2013/02/07 CHECKED BY: APPR:SMILLER 2014/02/05 DATE:	QUALITY SYMBOLS	GENERAL TOLERANCES (UNLESS SPECIFIED)	DIMENSION STYLE	SCALE	DESIGN UNITS	THIRD ANGLE PROJECTION
	▽=0	4 PLACES ± mm ± INCH	MM ONLY	4:1	METRIC	
	▽=0	3 PLACES ± 0.13 ± ---				
	▽=0	2 PLACES ± 0.25 ± ---				
		ANGULAR ± 2 °	DRAWN BY: SREED 2003/02/27	DATE: 2003/02/27	TITLE: VHDM 8-ROW DAUGHTERCARD STACKER CONNECTOR SALES DRAWING	
		DRAFT WHERE APPLICABLE MUST REMAIN WITHIN DIMENSIONS	CHECKED BY: JB INGHAM 2003/02/27	DATE: 2003/02/27	APPROVED BY: CBI XLER 2003/02/27	
			MATERIAL NO: SEE CHART	DOCUMENT NO: SD-75117-001	SHEET NO: 2 OF 2	
			THIS DRAWING CONTAINS INFORMATION THAT IS PROPRIETARY TO MOLEX INCORPORATED AND SHOULD NOT BE USED WITHOUT WRITTEN PERMISSION			

19 18 17 16 15 14 13 12 11 10 9 8 7 6 5 4 3 2 1