

THIS DOCUMENT IS SUBJECT TO CHANGE WITHOUT NOTICE. IT IS CONFIDENTIAL AND A PROPERTY OF AMPHENOL LTW. DISCLOSURE TO THIRD PARTY HAS TO BE AUTHORIZED BY AMPHENOL LTW.

REV.	ECN NO.	DATE	SIGN	DESCRIPTION
B	LEN14C0049	2014/11/25	Vicky	Update Logo & Dimension

**ALTW**  
 CONFIDENTIAL  
 2014-11-25  
 R&D DEPT.

**ALTW**  
 DCC. DEPT.  
 CONFIDENTIAL  
 2014.12.03  
 ISSUED

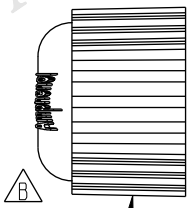

Sealing Nut (5)

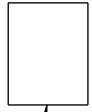

Seal (4)

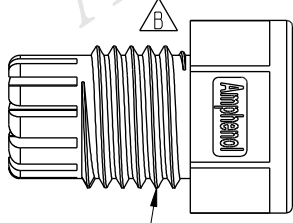

Clamp Ring (3)

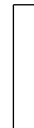

Gasket (2)

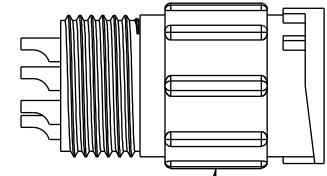

Connector (1)

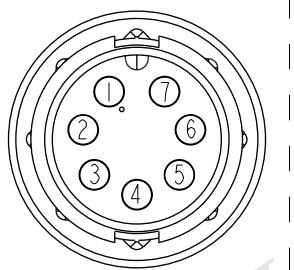

Pin Assignments  
Front View

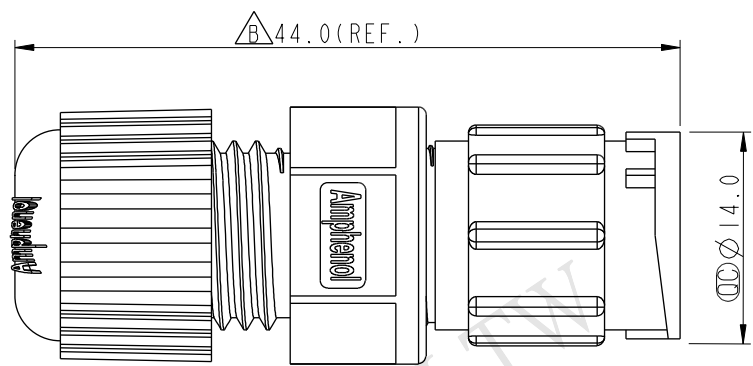

- Note:
- \*  $\varnothing$  Important Dimension To Check.
  - \* Waterproof Rate: IP67
  - \* Housing: Nylon+GF, Black
  - \* Male Pin: Copper Alloy, Gold Plated
  - \* Gasket: EPDM, Black
  - \* Clamp Ring: Nylon, Black
  - \* Seal: EPDM, Black
  - \* Sealing Nut: Nylon, Black
  - \* Seal For Cable OD:  $\varnothing 4.5\text{mm} \sim \varnothing 6.5\text{mm}$   
(防水墊圈線徑:  $\varnothing 4.5\text{mm} \sim \varnothing 6.5\text{mm}$ )
  - \* One Set Unassembled In One PE Bag  
(每一組未組裝, 放置於一個PE袋, 並封口)

UNIT: mm		
TOLERANCE		
.X	$\pm 0.25$	
.XX	$\pm 0.1$	
.XXX	$\pm 0.05$	
ANGLES	$\pm 1^\circ$	

TITLE Standard Assy Lock 7P M Conn M Pin			
SCALE 3:2	SIZE A4	SHEET 1 OF 1	
REV. B	WC-REV. A.2	$\varnothing$ : Inspection item	

**Amphenol LTW**  
 安費諾亮泰企業股份有限公司

ITEM NO. BD-07BMMA-LL7001	DRAWN BY Vicky	DATE 2014-11-25
DWG NO. BD-07BMMA-LL7001	CHECKED BY Sam	DATE 2014-11-25
CUSTOMER ALTW	APPROVED BY Rita	DATE 2014-11-25