

## Dual-Axis Quasi-static MEMS Mirror Datasheet

### A5L2.2-6400(AU/AL)

#### GENERAL OVERVIEW

Mirrorcle Technologies Gimbal-Less **Dual-Axis Quasi-static MEMS Mirrors** are based on proprietary design and fabrication technology. They provide fast optical beam steering across two axes, while requiring ultra-low power. The mirrors deflect laser beams or images to optical scanning angles of up to  $\pm 16^\circ$  on each axis. Compared to large-scale galvanometer-based optical scanners, these devices require several orders of magnitude less driving power: continuous operation of the electro-static actuators that drive the mirror tip-tilt rotation dissipates less than 1mW of power.

Mirrorcle Technologies MEMS Mirrors are made entirely of monolithic Single-Crystal Silicon (SCS), resulting in **excellent repeatability and reliability**. Flat, smooth mirror surfaces are coated with a thin film of metal with high broadband reflectance.

#### FEATURES

- Dual-Axis Gimbal-less MEMS Mirror
- 6.4mm diameter** round mirror (clear aperture)
- Optically flat, Aluminum or Gold coated
- $\pm 1.2^\circ$  Mechanical Tip-Tilt on Two Axes
- Electro-static Actuation
- Ultra-low power consumption
- Highest Point-to-Point Precision
- High robustness and reliability
- Wide operating temperature range
- Window options for visible and IR wavelengths

#### Applications

- Lidar / 3D Sensing
- Biomedical Microscopy and Imaging
- Free-space optical communication
- Laser Marking
- Laser alignment tools
- Laser designation and tracking

#### MODULAR DESIGN

Mirrorcle actuators lend themselves inherently to a modular design approach. Each actuator can utilize electrostatic rotators of arbitrary length, arbitrarily stiff linkages, and arbitrarily positioned mechanical rotation transformers. In addition, the device can have an arbitrarily large mirror diameter. This modularity easily allows the devices to be customized for any application requirement.

Due to this design flexibility and a wide variety of applications that require beam steering, with widely different specifications, we provide many types of gimbal-less **two-axis quasi-static** actuator designs. With over 20 major design series and manufacturing generations, multiple sub-generations of design tuning for a specific customer or set of specifications, the complete list of working designs has over 100 device types. Several of the designs are in series production.

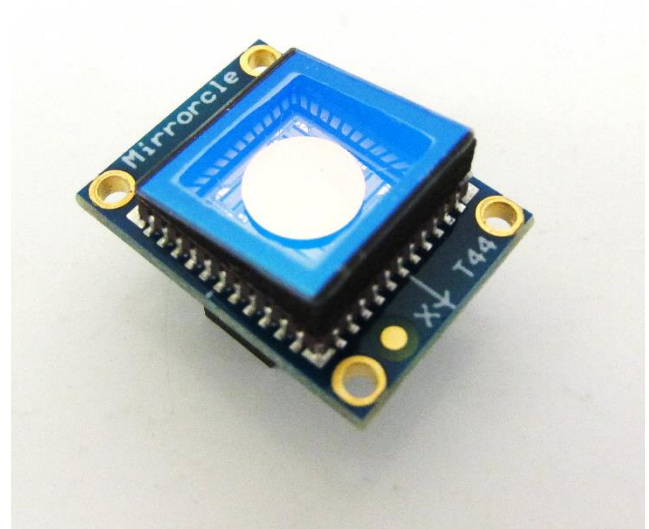

Figure 1. Image of the A5L2.2-6400AU-TINY48.4-C/W/EP device shown with a wedge and C-coated window. The 6.4mm mirror is gold-coated for optimized performance in near-IR and IR wavelengths. The connectorized package "TINY48.4" is 15mm x 20mm x 9mm

## MULTIPLE SCANNING MODES

Mirror devices can operate from dc (static) and quasi-static (point-to-point) response to dynamic, resonant modes. When operated near the resonant frequency, devices give significantly more angle at lower operating voltages and sinusoidal motion. Namely, the MEMS actuators utilize single-crystal Silicon springs to support the MEMS mirror and to provide restoring force during actuation. It is possible to define these modes of operation in three distinct categories shown below and in Fig. 2:

- a) In **point-to-point mode** or **quasi-static mode**, both axes are utilizing the wide bandwidth of operation of the device from DC to some frequency, and not allowing for resonance and ringing. Therefore, mirror can hold a DC position, move in a uniform velocity, perform vector graphics, linear raster patterns, etc.
- b) The second mode is a mixed mode in which one axis is used in **quasi-static mode**, and the other axis is used in **resonant mode**. A typical use case is to run one axis very fast (e.g. few kHz,) to create horizontal lines, and to run the other axis with a sawtooth-like waveform to create a raster pattern that covers a rectangular display or imaging area. The axis operating at resonance should have its parameters carefully obtained, initially at low voltages and angles, to avoid exceeding maximum mechanical angles.
- c) Third mode is **resonant mode**. In this case both axes are utilizing the narrow, high gain resonance to obtain large angles of deflection and relatively low voltages and high speeds. Motion is limited to very narrowband, sinusoidal trajectories with a phase lag to the applied voltage. Resulting 2D motion describes circles, ellipses, and various higher order Lissajous patterns and can be modulated at some rate. When devices that are designed for point-to-point mode are driven near or at resonance, they may exceed safe operating angles. Thus, near or at resonance operation is done with significantly lower voltages and with additional care.

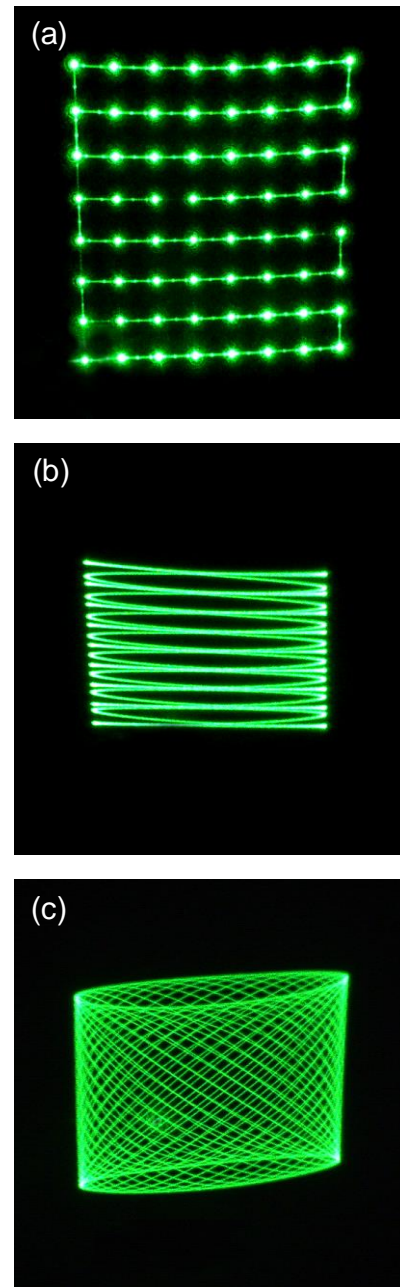

Figure 2. Photographs of examples of using Mirrorcle MEMS Mirror in (a) point-to-point scanning mode (quasi-static) on both axes with the laser beam stopping at each angle, then stepping to the next angle, (b) resonant scanning mode on the x-axis (sinusoidal beam motion) and quasi-static on the y-axis (triangle wave motion in this example), and (c) resonant scanning mode on both axes, showing a 2D resonant Lissajous pattern. All images were taken with a CW laser using the same Mirrorcle MEMS mirror.

# MEMS Mirror Device Specifications

## ABSOLUTE MAXIMUM RATINGS

The absolute maximum ratings are defined as limits to the electrical and mechanical design of the MEMS mirror, where exceeding the maximum voltage or the maximum mechanical tilt can cause permanent physical damage to the device. Damage is also possible above the stated angle when both axes are actuated simultaneously – where the total angle of mirror is as high as  $\sqrt{2}$  \* angle of either axis. The maximum voltage is defined as the voltage between any two terminals on the device. E.g. X+ to ground, or X+ to X-. Mirror flatness can be affected by exceeding the maximum temperature rating. Higher temperatures can change the stresses of the mirror's reflectivity coating and can permanently change the radius of curvature. The mirror surface temperature can also be increased by high laser powers, not just the temperature of the environment.

Parameter	Test Conditions	Max.	Units
Absolute Maximum Mechanical Tilt	Both axes simultaneously, each axis tilted with stated angle	2.0	Deg
Absolute Maximum Voltage	Voltage between any two terminals	184	V
Absolute Maximum Temperature	Max temperature can affect mirror surface quality	125	°C

## RECOMMENDED OPERATING CONDITIONS

Although the mirror can be actuated by waveforms with components from dc to practically infinity, with varied corresponding responses, for convenience of listing recommended conditions, we distinguish two regimes of operation: 1) static or quasi-static and 2) dynamic or resonant. The DC Static Mechanical tilt is defined as the deflection range of the MEMS mirror with DC (or equivalent very slow actuation). The Dynamic Mechanical Tilt is defined as peak amplitude mechanical tilt during sinusoidal motion at frequencies closer to the resonant frequency. This sinusoidal resonant response of the MEMS mirror results in a larger mechanical tilt gain at significantly lower voltages. With drive signals near resonance, or containing signal components near resonance, users should test with low drive voltages and ensure the device is never scanning beyond the Maximum recommended tilt angles to prevent any damage to the device.

Parameter	Test Conditions	Min.	Typ.	Max.	Units
DC Static Mechanical Tilt	Vbias = 90V, VdifferenceMax = 172V	±1.15	±1.22	±1.26	Deg
Dynamic Mechanical Tilt	Vbias = 90V, near first resonance			±1.5°	Deg
VdifferenceMax	Vbias = 90V		172	180	V
First Resonant Frequency	X-Axis	650		800	Hz
First Resonant Frequency	Y-Axis	650		800	Hz
First Resonance Quality Factor	Same for X-Axis and Y-Axis	45		70	
Second Resonant Frequency	Same for X-Axis and Y-Axis	3600		4000	Hz
Second Resonance Quality Factor	Same for X-Axis and Y-Axis	100		500	
Recommended Low Pass Filter (LPF)	Same for X-Axis and Y-Axis		300		Hz
X-Axis Step Response w/ LPF	0° to 2° Step Input with Recommended LPF		3.5		ms
Y-Axis Step Response w/ LPF	0° to 2° Step Input with Recommended LPF		3.5		ms
Point-to-Point Precision	Repeatability at room temperature		0.2		mDeg

### WARNING



Proper ESD protection and a clean environment is needed when handling Mirrorcle MEMS mirrors to prevent any damage from electro-static discharge, or any dust particles landing on the MEMS mirror.

## MIRROR SPECIFICATIONS

Mirrorcle Technologies MEMS Mirrors are fabricated out of single-crystal Silicon wafers of the same prime grade and quality that is used for the manufacturing of integrated circuits with Silicon used as the base material. The wafer surfaces and therefore fabricated mirror surfaces are polished to below 1nm roughness with world's best polishing technologies. Also unique to Silicon based microfabrication is the availability of methodologies to make the surfaces ultra-clean prior to mirror metallization. Furthermore, the Silicon material is inherently without any residual stress from its manufacturing and maintains this property after mirror microfabrication. Therefore, Silicon mirrors have extremely high flatness, with curvature often below level measurable with conventional interferometers. As the base material in a MEMS mirror, Silicon has the optimal properties of smoothness, cleanliness, and flatness.

In the final manufacturing step for optical beam steering applications, the Silicon mirror must be coated for high reflectance at required optical wavelengths. In our standard production processes, we coat the Silicon mirrors with a thin film of pure Aluminum or pure Gold. All in-stock MEMS mirrors are available with the Aluminum coating and some of the designs are available with the Gold coating.

Device mechanical dimensions are listed below. The Mirror surface diameter is defined by (a). The total MEMS actuator die thickness is defined as (b). The total die width is defined as (d). The height of the pedestal and mirror is defined as (f). The distance from the center of rotation of the device is off to the top of the mirror surface is offset, defined by (e).

Parameter	Test Conditions	Min.	Typ.	Max.	Units
Mirror Diameter (a)	Diameter is also the Clear Aperture	6.36	6.4	6.44	mm
Mirror Radius of Curvature	Spherical term fit over whole mirror	5			m
Mirror Surface Roughness	RMS value (Rq)			10	nm
Mirror Coating	Metal thin-film (no protection layer)	Gold			
Mirror Reflectance	750nm-2000nm, 22.5° AOI	95			%
Mirror Coating Thickness	Metallization layer	50	60	70	nm
Mirror Coating Thickness	Metallization layer	Aluminum			
Mirror Reflectance	350nm-2000nm, 22.5° AOI	80	95		%
Mirror Coating Thickness	Metallization layer	60	70	80	nm
Total Die Thickness (b)		0.4962	0.5012	0.5062	mm
Total Die Width (d)	Square Die	7.23	7.25	7.27	mm
Mirror center of rotation (e)	Difference between center of rotation (origin) to top of mirror surface	0.511	0.516	0.521	mm
Mirror Stand-Off Height (f)	Pedestal height for the bonded mirror	0.446	0.451	0.456	mm

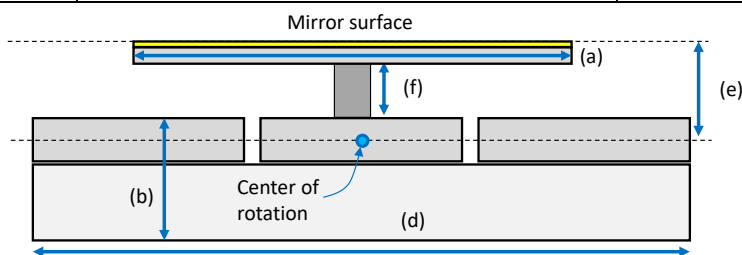

## ENVIRONMENTAL AND MECHANICAL CONDITIONS

Parameter	Test Conditions	Min.	Typ.	Max.	Units
Operating Temperature Range	No Condensation, Relative Humidity < 60%	-40		105	°C
Storage Temperature Range	No Condensation, Relative Humidity < 60%	-40		105	°C
Mechanical Shock	Survives at least stated level (all 3 axes)	100			g
Vibration	Passes tests (20g, 4 min/cycle, 4 cycles/ axis)	20		2000	Hz



# MEMS Mirror Device Typical Characteristics

Note: These curves shown below are typical responses that are characteristic for this type of device. Individual device responses may vary by  $\pm 15\%$  or more

### DC Static Response

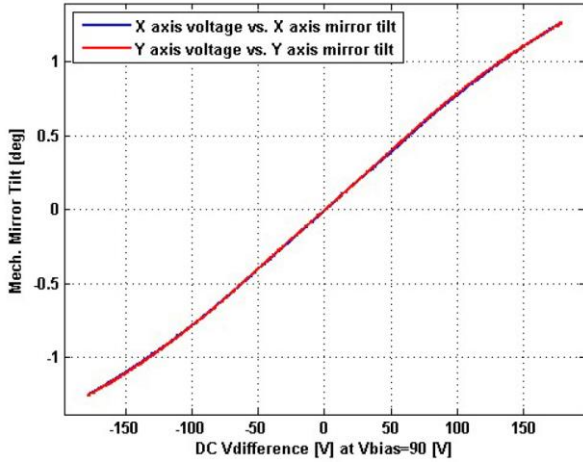

During the characterization/test process, a MEMS device is driven to maximum positive and negative Vdifference about the Vbias voltage, and the corresponding angles are recorded. This test ensures the device can reach the maximum specified mechanical tilt angle.

### Small Signal Frequency Response - Magnitude

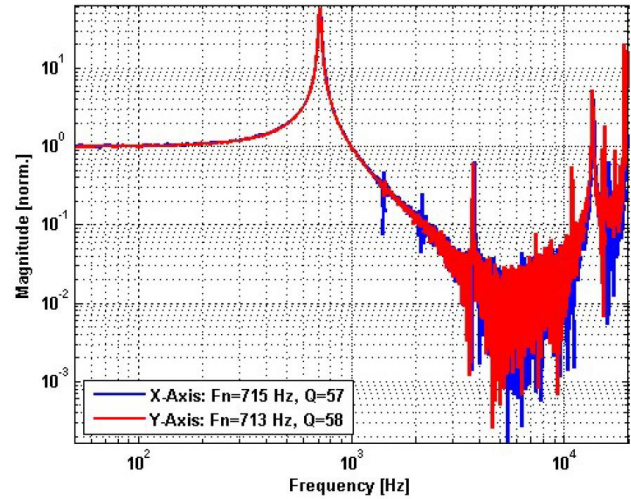

### Small Signal Frequency Response - Phase

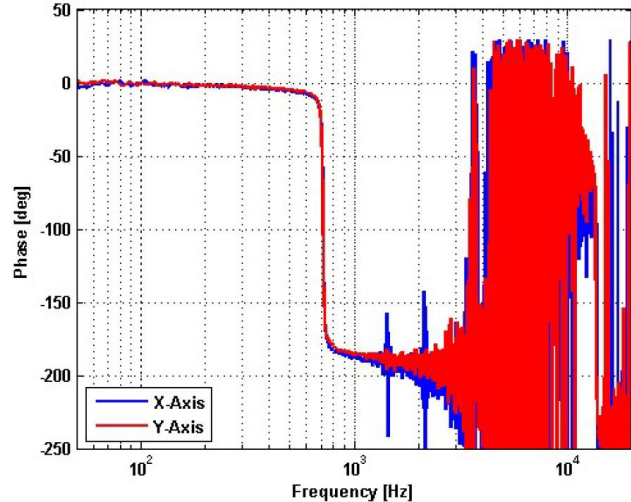

### Step Response

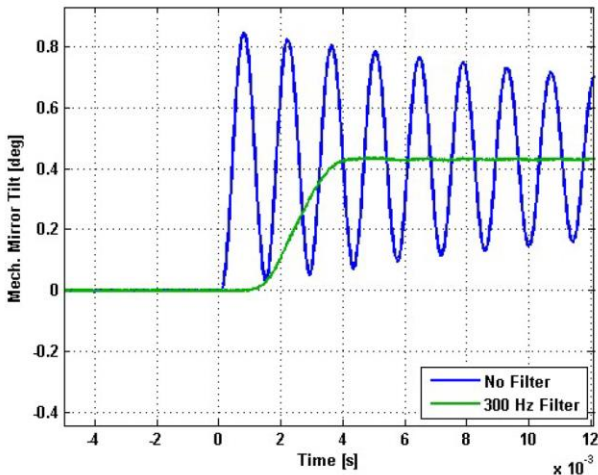

The MEMS device is also driven with a step waveform with the recommended low-pass filter, and without any filtering to show the step responses of the device. The low-pass filtered waveform's step response is governed by the filter bandwidth and has no overshoot or ringing / oscillation. The unfiltered waveform has a large ring and takes  $>50\text{ms}$  to fully settle.

A wide band (0-20kHz) and very small amplitude noise waveform is applied to the MEMS driver and the mirror's response is measured by the 2D PSD for each axis. From the input (waveform) and output (device angle), a complex frequency response (amplitude and phase) is obtained and plotted for each axis.

PRELIMINARY

PRELIMINARY

---

# MEMS Mirror Driving Recommendations

---

## LINEARIZED DRIVING OF FOUR-QUADRANT (4Q) DEVICES

**Mirrorcle Development Kits** and OEM MEMS drivers utilize a device-specific method of driving the 4Q MEMS actuators with a Bias-Differential Quad-channel (BDQ) scheme. This scheme linearizes actuators' voltage-angle relationship and improves smooth transitions from one actuator to another within the device. In this mode both the positive rotation portion and the negative rotation portion of each rotator are always (differentially) engaged, and therefore the voltages and torques are always continuous. All Mirrorcle MEMS drivers are designed to operate in this mode and therefore have four channels with biased output (two differential pairs). Inputs are either digital or analog and only two channels are required to command x-axis and y-axis position.

## MEMS MIRROR MODULE

MEMS Mirror Modules (MMM) combine a MEMS Mirror with a MEMS Driver, allowing users to conveniently and safely control MEMS mirrors from their own hardware platforms (e.g. NIDAQ, MCU or FPGA module).

The recommended MEMS Mirror Module for this product includes the Analog-Input MEMS Driver with T180 driving, also termed "BDQ PicoAmp T180" (P/N: DR-11-055-00). As mentioned, use of the Analog MEMS Driver requires bench-top lab equipment such as function generators or a data acquisition (DAQ) card. Its -10V to +10V input range is particularly well suited for use with National Instruments NIDAQ cards.

For convenient experimentation with the driver, a breakout PCBA is added in the bundle which breaks out the MEMS Driver input connector into convenient terminals and test points.

## DRIVING RECOMMENDATIONS

**Mirrorcle strongly recommends** all first-time users of the MEMS mirrors to start with a Development Kit. The Development Kit comes with a USB MEMS Controller, three different MEMS mirrors, red laser and optical breadboarding with mounts for the MEMS mirror and laser. The Development Kit also includes an extensive Software Suite with SDKs in C++, Matlab and LabView, with options to upgrade to Python, and C++ for Linux (Ubuntu x64 platform). In addition to the SDKs, the Software Suite also includes Windows based Applications like MirrorcleDraw, MTIDevice-Demo, Mirrorcle Linear Raster, etc. The development kit allows users to quickly setup the MEMS mirror to perform an incoming inspection and evaluate the device for their specific application. MirrorcleDraw is a powerful software that enables the user to generate or import content, quickly change the size, rotation, filter settings, refresh rate and many other settings.

For users ready to integrate the MEMS Mirror into their applications, various levels of integration are available, starting at the lowest level with analog input or digital input MEMS Drivers (see MEMS Mirror Module section earlier). MEMS Drivers require the user to generate the MEMS Mirror position signals on their own processor / platform.

For users that prefer a higher level of integration, and use of software to interface with the MEMS Mirror, a MEMS Mirror System (MMS) is recommended. An MMS includes a MEMS Mirror with a USB MEMS Controller and Software. The USB MEMS Controller is able to receive all the same API commands in the various software languages provided in the SDKs. However, in production it is offered in multiple different OEM versions with different form factor and features.

### Recommended MEMS Mirror Module Part Numbers:

- EMMM160-C/W/EP-MC: MEMS Mirror Module, 2D Quasistatic, 6.4mm AL, C, AIN-ED
- EMMM160-AB/W/EP-MC: MEMS Mirror Module, 2D Quasistatic, 6.4mm AL, AB, AIN-ED
- EMMM161-C/W/EP-MC: MEMS Mirror Module, 2D Quasistatic, 6.4mm AU, C, AIN-ED
- EMMM161-AB/W/EP-MC: MEMS Mirror Module, 2D Quasistatic, 6.4mm AU, AB, AIN-ED

# MEMS Mirror Electrical Connections

## TINY48.4 CIRCUIT AND CONNECTIONS

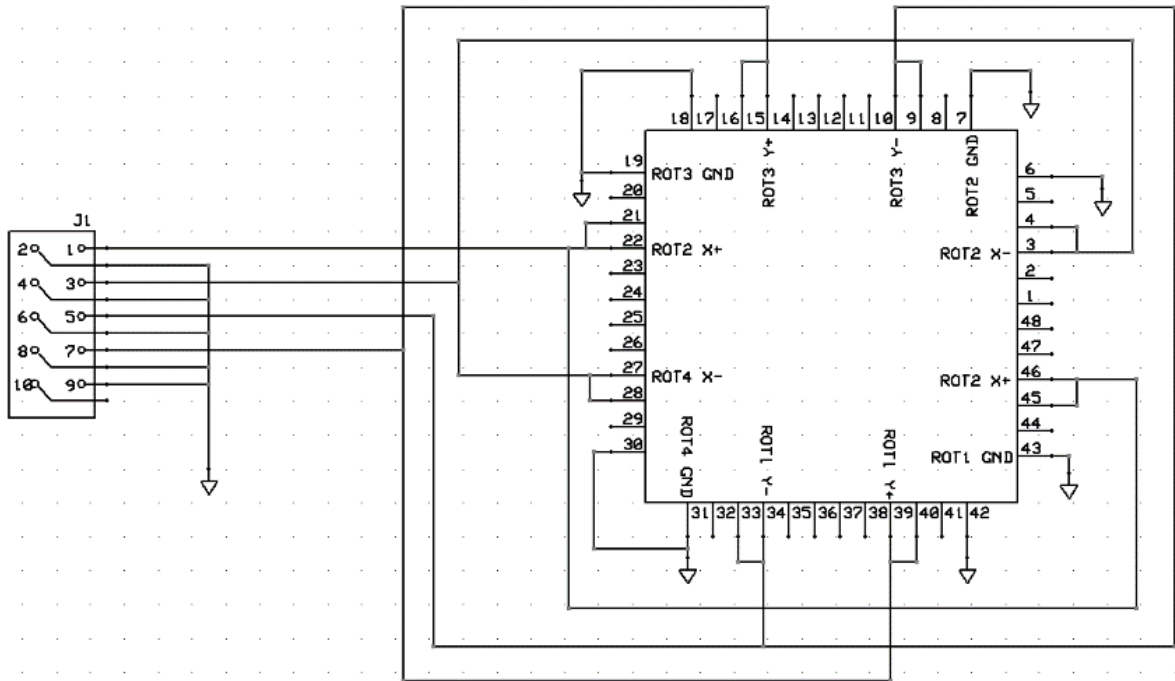

**10 - Pin Header – J1**

Pin	Name	Description
1	HV_A (X+)	MEMS Channel X+
2	GND	Ground
3	HV_B (X-)	MEMS Channel X-
4	GND	Ground
5	HV_C (Y-)	MEMS Channel Y-
6	GND	Ground
7	HV_D (Y+)	MEMS Channel Y+
8	GND	Ground
9	N/C	No Connection
10	N/C	No Connection

Connector Part No.	Pins
Digikey ID: 1175-1629-ND	10
Recommended Mating Cable	
Cable: SAM8219-ND	



### HIGH VOLTAGE WARNING

Mirrorcle MEMS Drivers are High Voltage Amplifiers that can produce hazardous voltages and currents which may be harmful. Use caution and exercise preventative safety measures to prevent contact between the high voltages and any personnel or equipment.

# MEMS Mirror Mechanical Specifications

## A5L2.2-6400AU-TINY48.4-NW DIMENSIONS

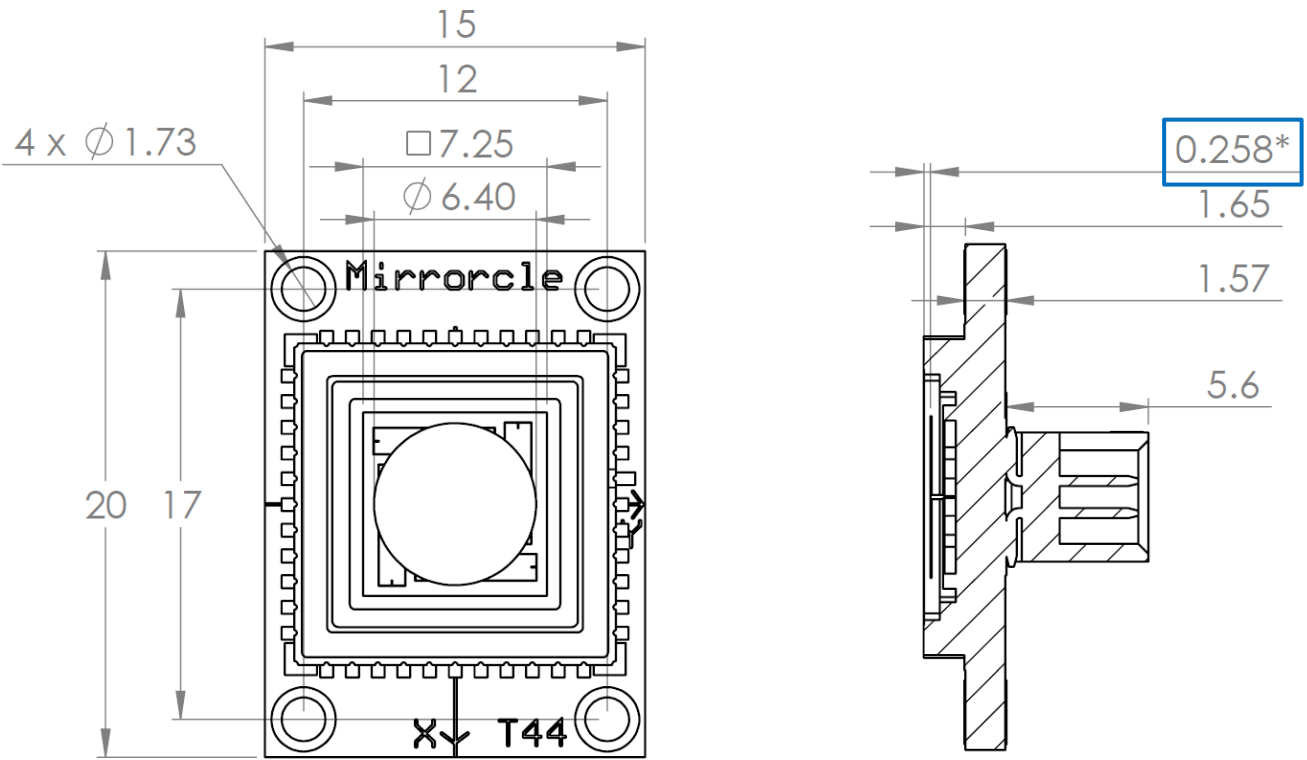

This drawing is of the device and package only. See next page for cover attach.

\*Distance from surface of MEMS mirror to top of LCC Cavity

MEMS Mirror and LCC Cavity Tolerances:  $\pm 100\mu\text{m}$   
 PCB Parts, Holes and Dimensions Tolerances:  $\pm 125\mu\text{m}$   
 All units in mm

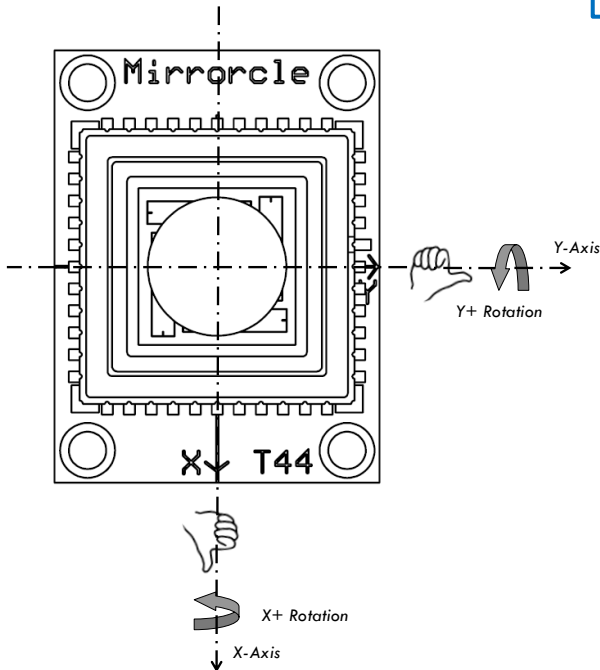

### Definitions:

$$V_{\text{difference}}(X) = HV\_A - HV\_B$$

$$V_{\text{difference}}(Y) = HV\_C - HV\_D$$

### X Axis:

$V_{\text{difference}}(X) > 0$  results in X+ rotation about the x-axis

$V_{\text{difference}}(X) < 0$  results in X- rotation about the x-axis

### Y Axis:

$V_{\text{difference}}(Y) > 0$  results in Y- rotation about the y-axis

$V_{\text{difference}}(Y) < 0$  results in Y+ rotation about the y-axis

PRELIMINARY

PRELIMINARY



# MEMS Mirror Part Name and Cover Specifications

## MEMS Mirror Part Name Format:

**AAAA.A-BBBBCC-DDDD-EE/FF/GG**

- **AAAA.A:** MEMS actuator Design ID (e.g.: A5L2.2)
- **BBBB:** Mirror diameter in microns (e.g.: 6400)
- **CC:** Mirror coating (AL, AU, or SI for uncoated Silicon)
- **DDDD:** MEMS carrier package ID (e.g.: TINY48.4)
- **EE:** Cover window selection (e.g.: B)
- **FF:** Wedge option: 'W' for Wedge, 'F' for Flat
- **GG:** Cover attachment method (e.g.: EP)

## Window Coating Options (EE section above)

Window Coating	Coating Range [Min]	Coating Range [Max]	AOI [°]	Transmittance [%]	P/N Designation
Type A	400 nm	675 nm	22.5°	>98%	A
Type B	675 nm	1040 nm	22.5°	>98%	B
Type AB	400 nm	1000 nm	22.5°	>96%	AB
Type C	1040 nm	1600 nm	22.5°	>98%	C

- All four window types transmittance are specified for  $\pm 10^\circ$  from AOI (Angle of Incidence) of  $22.5^\circ$
- **EE/FF/GG** can be denoted as NW if there is no cover attached.

## Wedge for Tilted Window (FF section above)

- The AR-coated window can be mounted on an anodized aluminum wedge with a tilt to avoid reflections from the window to appear within (near the center of) the MEMS field-of-regard.
- The standard wedge is designed with a  $11^\circ$  tilt about the MEMS Y-axis (negative rotation about the Y-axis, sending the residual reflection UP)

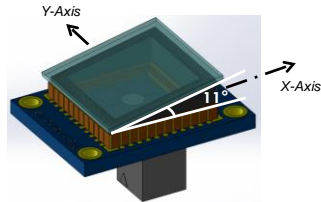

Axes Orientation: Window with Wedge

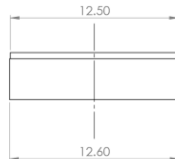

Mechanical Dimensions: Window with Wedge

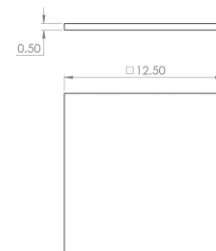
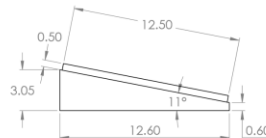

Mechanical Dimensions: Flat Window

## Package Cover Attachment Options (GG section above)

- There are 3 methods of attaching the cover to the package:
- The cover is permanently attached to the package using adhesive. Part: **/EP**
- The cover is attached to the MEMS package using double-sided tape on all 4 edges. Part: **/TP**
- A cover with temporary window (uncoated) is lightly attached for easy removal using double-sided tape on only 2 edges. Part: **/TW**

Example with Wedge and A-Type Window with Epoxy: A5L2.2-6400AU-TINY48.4-A/W/EP

Example without Wedge and B-Type Window with Tape: A5L2.2-6400AU-TINY48.4-B/F/TP

PRELIMINARY

PRELIMINARY

---

# Mirrorcle Technologies, Inc.

---

## DISCLAIMERS AND WARRANTY STATEMENT

This is a preliminary information datasheet for a product which is in preproduction stage, intended as a Product Preview with limited distribution to potential users. It is not intended as a production specification for any customer or case. For most up to date product and design-to information, potential users should always contact Mirrorcle Technologies and jointly work toward a final series-production Product Specifications.

Mirrorcle Technologies, Inc. reserves the right to make changes without further notice to any products or specifications herein. Mirrorcle Technologies, Inc. does not assume any responsibility for use of any its products for any particular purpose, nor Mirrorcle Technologies, Inc. assume any liability arising out of the application or use of any its products or circuits. Mirrorcle Technologies, Inc. does not convey any license under its patent rights or other rights nor the rights of others.

Mirrorcle MEMS devices are recommended to be driven by Mirrorcle driver electronics. Use with MEMS Drivers not manufactured by Mirrorcle Technologies voids warranty. Removal of window and any significant device alteration including soldering voids warranty. Qualified incoming inspection of the MEMS Mirror products, as required by Terms and Conditions of sale shall be performed with Mirrorcle Controller and Software.

Terms and Conditions of Sale: [www.mirrorcletech.com/pdf/MTI-Sales-Terms.pdf](http://www.mirrorcletech.com/pdf/MTI-Sales-Terms.pdf)

## ADDITIONAL RESOURCES

Development Kits: [www.mirrorcletech.com/wp/products/devkits/](http://www.mirrorcletech.com/wp/products/devkits/)

Products List: [https://www.mirrorcletech.com/pdf/Mirrorcle\\_Products\\_List.pdf](https://www.mirrorcletech.com/pdf/Mirrorcle_Products_List.pdf)

## WORLDWIDE SALES AND SERVICE

### Headquarters Address:

4905 Central Ave Ste 200  
Richmond, CA 94804  
U.S.A.

Worldwide Sales Representative: [Sales@mirrorcletech.com](mailto:Sales@mirrorcletech.com)

Additional documentation and support available at <https://mirrorcletech.com/wp/support>

