

**SC**

**SINGLEMODE FIBER OPTIC CONNECTOR**

Outer plug body and boot: color green

Series	Packaging	Issue	Page
F728	100	31Dec.10	1/1

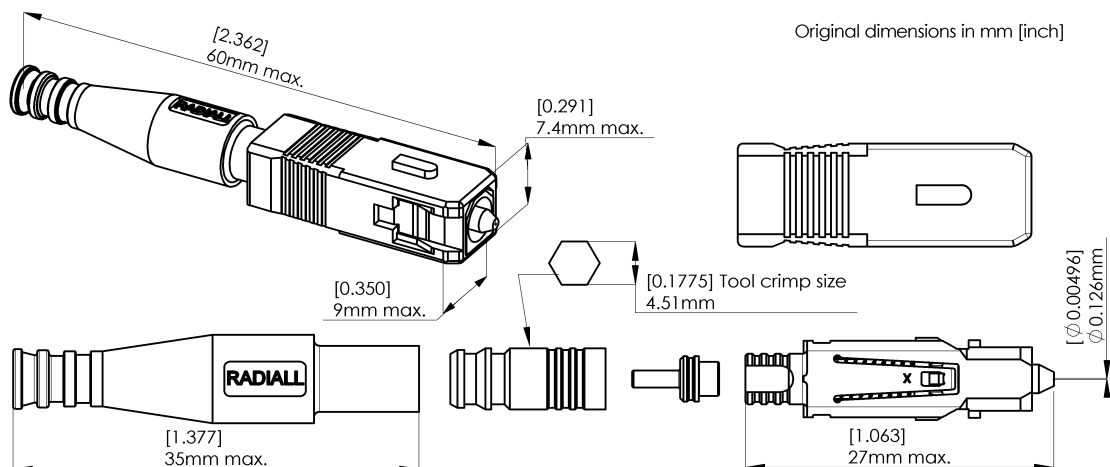

**GENERAL**

**Type** : IEC 61754-4 type SC  
 Singlemode, zirconia APC ceramic ferrule (pencil type)  
 Push-pull latching system, floating ferrule  
 360°tunable (adjustable to 6 positions for optimization of random insertion loss)

**Ferrule size** : 126 µm  
**Fiber size** : 9,5 /125 µm, singlemode

**Cable** : Ø 2mm cable, tight or semi loose structure

**Cabling proc.** : Refer to 503 08 400 (D 6121 oe), assembly instruction manual

**CHARACTERISTICS** (Dependant on fiber or cable construction)

**Optical** : Attenuation at 1310 and 1550 nm, LD

	STD	TUNED (IEC 61300-2-40)	
Mean	< 0.2 dB	< 0.2 dB	(Attenuation plug mated with reference plug IEC 61300-3-4)
Standard deviation	0.15 dB	0.15 dB	
Max	< 0.8 dB, 97%	< 0.6 dB, 99%	(Attenuation of random mated connectors IEC 61300-3-34)
Mean	0.25 dB	0.15 dB	
Repeatability	0.10 dB	0.10 dB	(Maximum loss variation, IEC 61300-2-2)
Return loss	> 60 dB	> 60 dB	(IEC 61300-3-6)

**Mechanical** : Mechanical endurance 500 matings  
 Cable retention 100N

**Environmental** : Temperature range (storage/operating) -40 to +85 °C

CREATION					<b>RADIALL®</b> 101, rue P. Hoffmann 93116 ROSNY/BOIS FRANCE Tel : (33) 0149353535 Fax : (33) 0148546363
N°:					
PEN/EP: CAT.					
Name: PB					
Date: 11 Aug. 99	31 Dec. 10	Mise à jour performances optiques et mécaniques	SP	HD	
Appr.: LV	Issue	Revisions	Name	Appr.	