

## FLLD3075AMHT5

Aliases (LLD3075AMHT5)

KEMET, FLLD3-MH, EMI/RFI Filters, Noise Suppression, 530 VAC, 75 A, 240x80x135mm

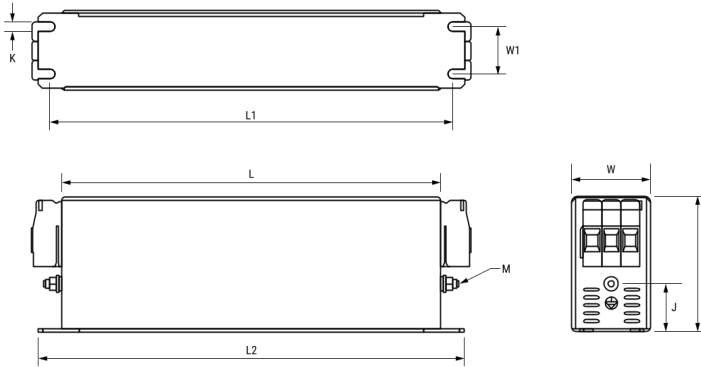

Click [here](#) for the 3D model.

### Dimensions

L	240mm NOM
W	80mm NOM
H	135mm NOM
L1	255mm NOM
L2	270mm NOM
W1	60mm NOM
J	70mm NOM
K	6.5mm NOM
M (Earth)	Threaded Studs M6

### Packaging Specifications

Packaging	Bulk
Packaging Quantity	1
Component Weight	3200 g

### General Information

Series	FLLD3-MH
Style	Chassis Mount
Description	EMI Filter, Chassis Mount, Motor Drives
Features	Three Phase, High Performance, High Voltage
Phase	Three-phase
RoHS	Yes
Qualifications	IEC/EN 60939, UL 1283
Terminal Type	Threaded Studs M6

### Specifications

Voltage AC	530 VAC, 305 VAC
Rated Frequency	50-60 Hz
Rated Current	75 A (50°C)
Rated Temperature	50°C
Temperature Range	-25/+100°C
Climate Category	25/100/21
Test Voltage DC (P to P)	2250 VDC
Test Voltage DC (P to E)	3000 VDC
Power Loss	30 W (25°C 50 Hz)
Leakage Current	4.7 mA