

## Item description

### Female connector/socket *WINSTA*® MIDI 4-pole

For power and signal transmission: The *WINSTA*® MIDI female connector/socket 4-pole. On PCBs, in control cabinets or for connecting lights – pluggable installation connectors from WAGO allow you to make connections according to an enormous variety of requirements in no time flat. The coding options reduce installation errors, allowing fast, maintenance-free wiring of all components. The pluggable installation connector is protected against ingress by solid objects in accordance with protection type IP20 (When mated and secured with a strain relief housing: IP2xC (These compact connectors are not designed for use in open, easily accessible areas!)). B coding enables the *WINSTA*® MIDI pluggable installation connectors to be used for control in applications in automation, robotics, and mechanical engineering. Important parameters in the selection of a pluggable installation connector are the rated current and voltage: They provide information about possible domains of use and applications. This product has a current rating of 25 A – as a result it is suitable for high power loads. The *WINSTA*® MIDI Pluggable Connection System with Push-in CAGE CLAMP® spring pressure connection technology facilitates exemplary electrification. Thanks to the built-in test slot, it is possible to check connections even when they are plugged in. That saves time and reduces installation labor and costs.

### Lower costs through fast commissioning and elimination of service expenses – solutions from *WINSTA*® MIDI

Subject to changes. Please also observe the further product documentation!



The WINSTA® Pluggable Connection System allows pluggable electrical installation. This significantly reduces the need for servicing and lowers costs. Now you can also lower installation expenses without compromising quality and safety: The WINSTA® MIDI pluggable installation connector with marking reduces the need for servicing and prevents unnecessary downtime.

- protection against mismatching eliminates errors
- pre-assembled versions
- with B coding for use in automation of processes, such as lighting technology, among other examples
- ready to install and use immediately
- fast, secure installation

## Data

### Notes

Variants: Other pole markings  
Other versions (or variants) can be requested from WAGO Sales or configured at <https://configurator.wago.com/>.

## Electrical data

### Ratings per IEC/EN

Ratings per	IEC/EN 60664-1
Nominal voltage (III/3)	400 V
Rated impulse voltage (III/3)	6 kV
Rated current	25 A
Note (rated current)	25 A for 3-pole load 20 A for 4-pole load
Legend (ratings)	(III / 3) ≙ Overvoltage category III / Pollution degree 3

### Ratings per UL 1977

Note for the US market	Some versions may also be used for current interruption in accordance with the UL certificate in select applications with currents below 16 A and voltages up to 600 V. For further information, please contact your local sales office.
Rated voltage (UL 1977)	600 V
Rated current UL 1977	23 A

## General

Note on contact resistance approx. 1 mΩ of contact resistance

Subject to changes. Please also observe the further product documentation!

approx. 0.25 mΩ contact transition plug/socket

## Connection data

Connection points	8
Total number of potentials	4

## Connection 1

Connection technology	Push-in CAGE CLAMP®
Actuation type	Operating tool Push-in
Nominal cross-section	4 mm <sup>2</sup> / 12 AWG
Solid conductor	0.5 ... 4 mm <sup>2</sup> / 20 ... 12 AWG
Solid conductor; push-in termination	1.5 ... 4 mm <sup>2</sup> / 16 ... 12 AWG
Stranded conductor	0.5 ... 2.5 mm <sup>2</sup> / 20 ... 14 AWG
Fine-stranded conductor	0.5 ... 4 mm <sup>2</sup> / 20 ... 12 AWG
Fine-stranded conductor; with insulated ferrule	0.25 ... 1.5 mm <sup>2</sup> / 20 ... 16 AWG
Fine-stranded conductor; with uninsulated ferrule	0.25 ... 2.5 mm <sup>2</sup> / 20 ... 14 AWG
Fine-stranded conductor; with ferrule; push-in termination	1.5 mm <sup>2</sup> / 16 AWG
Strip length	9 mm / 0.35 inches
Pole number	4
Conductor entry direction to mating direction	0°

## Physical data

Pin spacing	10 mm / 0.394 inches
Width	40 mm / 1.575 inches
Height	12.9 mm / 0.508 inches
Depth	37.5 mm / 1.476 inches

## Mechanical Data

Application	Control technology
Coding	B
Variable coding	Yes
Marking	1 2 3 4
Potential marking	1 2 3 4
Mating force of a plug-in connection	approx. 20 ... 70 N (depending on pole number)
Retention force of a plug-in connection	Locked: > 80 N

Subject to changes. Please also observe the further product documentation!



Unmating force of a plug-in connection	Unlocked: approx. 20 ... 70 N (depending on pole number)
Number of mating cycles	200, without resistive load
Protection type	IP20; When mated and secured with a strain relief housing: IP2xC (These compact connectors are not designed for use in open, easily accessible areas!)

## Plug-in connection

Contact type (pluggable connector)	Female connector/socket
Connector (connection type)	for conductor
Mismating protection	Yes
Note on mismating protection	All <i>WINSTA</i> <sup>®</sup> components are 100% protected against mismating when: a.) plugging different numbers of poles b.) plugging while rotated 180 c.) plugging while laterally staggered d.) plugging one pole
Locking lever	Can be retrofitted
Locking of plug-in connection	locking lever
Note on locking system	All connectors for mounted installations (snap-in versions for lighting fixtures or devices, all types of PCB and distribution connectors) are factory-equipped with locking levers to ensure plugs and sockets are securely locked. Additional locking levers are only required for flying leads (plug/socket).

## Material Data

Note (material data)	Information on material specifications can be found here
Color	gray
Cover color	gray
Material group	I
Insulation material	Polyamide (PA66)
Flammability class per UL94	V0
Clamping spring material	Chrome-nickel spring steel (CrNi)
Contact material	Copper or copper alloy; surface-treated
Contact plating	Tin
Fire load	0.32 MJ
Weight	12.6 g

Subject to changes. Please also observe the further product documentation!

## Environmental requirements

Processing temperature	-5 ... +40 °C
Continuous operating temperature	-35 ... +85 °C
Note on continuous operating temperature	Insulating parts for temperatures ≤ 105 °C

## Commercial data



Product Group	20 (Winsta)
eCl@ss 10.0	27-44-06-05
eCl@ss 9.0	27-44-06-05
ETIM 8.0	EC002560
ETIM 7.0	EC002560
PU (SPU)	50 pcs
Packaging type	box
Country of origin	DE
GTIN	4044918252447
Customs tariff number	85366990990

## Environmental Product Compliance

RoHS Compliance Status	Compliant, No Exemption
------------------------	-------------------------

## Approvals / Certificates

### General approvals

Logo	Approval	Additional Approval Text	Certificate name
	CCA DEKRA Certification B.V.	IEC 61984	NL-32104
	CCA DEKRA Certification B.V.	EN 61984	2173495.01
	cURus Underwriters Laboratories Inc.	UL 1977	E45171

## Declarations of conformity and manufacturer's declarations

Logo	Approval	Additional Approval Text	Certificate name
------	----------	--------------------------	------------------

Subject to changes. Please also observe the further product documentation!

WAGO GmbH & Co. KG  
 Hansastr. 27  
 32423 Minden  
 Phone: +49571 887-0 | Fax: +49571 887-169  
 Email: [info.de@wago.com](mailto:info.de@wago.com) | Web: [www.wago.com](http://www.wago.com)

Do you have any questions about our products?  
 We are always happy to take your call at +49 (571) 887-44222.



EU-Declaration of Conformity  
WAGO GmbH & Co. KG

-

-





UK-Declaration of Conformity  
WAGO GmbH & Co. KG

-

-

#### Approvals for marine applications

Logo	Approval	Additional Approval Text	Certificate name
	<b>ABS</b> American Bureau of Shipping	-	19- HG1868589- PDA
	<b>DNV GL</b> Det Norske Veritas, Germanischer Lloyd	-	TAE00001Z6
	<b>LR</b> Lloyds Register	IEC 61984	LR22429487TA

#### Counterpart



**Item no.770-1631**

T-distribution connector; 4-pole; Cod. B; 1 input; 2 outputs; 2 locking levers; gray

[www.wago.com/770-1631](http://www.wago.com/770-1631)



**Item no.770-1681**

h-distribution connector; 4-pole; Cod. B; 1 input; 2 outputs; outputs on one side; 2 locking levers; gray

[www.wago.com/770-1681](http://www.wago.com/770-1681)



**Item no.770-1731**

T-distribution connector; 4-pole; Cod. B; 1 input; 2 outputs; 3 locking levers; for flying leads; gray

[www.wago.com/770-1731](http://www.wago.com/770-1731)



**Item no.770-1734**

3-way distribution connector; 4-pole; Cod. B; 1 input; 3 outputs; gray

[www.wago.com/770-1734](http://www.wago.com/770-1734)

**Item no.770-254**

Subject to changes. Please also observe the further product documentation!

WAGO GmbH & Co. KG

Hansastr. 27

32423 Minden

Phone: +49571 887-0 | Fax: +49571 887-169

Email: [info.de@wago.com](mailto:info.de@wago.com) | Web: [www.wago.com](http://www.wago.com)

Do you have any questions about our products?

We are always happy to take your call at +49 (571) 887-44222.



Plug; 4-pole; Cod. B; 4,00 mm<sup>2</sup>; gray

[www.wago.com/770-254](http://www.wago.com/770-254)



**Item no.770-1781**

h-distribution connector; 4-pole; Cod. B; 1 input; 2 outputs; outputs on one side; 3 locking levers; for flying leads; gray

[www.wago.com/770-1781](http://www.wago.com/770-1781)



**Item no.770-754**

Snap-in plug; 4-pole; Cod. B; 4,00 mm<sup>2</sup>; gray

[www.wago.com/770-754](http://www.wago.com/770-754)



**Item no.770-854**

Plug for PCBs; straight; 4-pole; Cod. B; gray

[www.wago.com/770-854](http://www.wago.com/770-854)



**Item no.770-854/011-000**

Plug for PCBs; angled; 4-pole; Cod. B; gray

[www.wago.com/770-854/011-000](http://www.wago.com/770-854/011-000)



**Item no.771-9994/005-103**

pre-assembled interconnecting cable; Eca; Socket/plug; 4-pole; Cod. B; Control cable 4 x 1.0 mm<sup>2</sup>; 1 m; 1,00 mm<sup>2</sup>; gray

[www.wago.com/771-9994/005-103](http://www.wago.com/771-9994/005-103)



**Item no.771-9994/205-103**

pre-assembled connecting cable; Eca; Plug/open-ended; 4-pole; Cod. B; Control cable 4 x 1.0 mm<sup>2</sup>; 1 m; 1,00 mm<sup>2</sup>; gray

[www.wago.com/771-9994/205-103](http://www.wago.com/771-9994/205-103)

## Required accessories

### Strain relief

Strain relief housing



**Item no.: 770-504/023-000**

Strain relief housing; 4-pole; for 2 cables; 5.0 ... 9.0 mm; 55 mm; black

[www.wago.com/770-504/023-000](http://www.wago.com/770-504/023-000)



**Item no.: 770-514**

Strain relief housing; 4-pole; for 2 cables; 9.0 ... 13.0 mm; 55 mm; white

[www.wago.com/770-514](http://www.wago.com/770-514)



**Item no.: 770-504**

Strain relief housing; 4-pole; for 2 cables; 9.0 ... 13.0 mm; 55 mm; black

[www.wago.com/770-504](http://www.wago.com/770-504)



**Item no.: 770-514/023-000**

Strain relief housing; 4-pole; for 2 cables; 5.0 ... 9.0 mm; 55 mm; white

[www.wago.com/770-514/023-000](http://www.wago.com/770-514/023-000)

### Locking levers

Locking system



**Item no.: 770-121**

Locking lever; for flying leads; for manual operation; white

[www.wago.com/770-121](http://www.wago.com/770-121)

Subject to changes. Please also observe the further product documentation!

WAGO GmbH & Co. KG

Hansastr. 27

32423 Minden

Phone: +49571 887-0 | Fax: +49571 887-169

Email: [info.de@wago.com](mailto:info.de@wago.com) | Web: [www.wago.com](http://www.wago.com)

Do you have any questions about our products?

We are always happy to take your call at +49 (571) 887-44222.



**Item no.: 770-131**

Locking lever; for flying leads; for tool operation; white

[www.wago.com/770-131](http://www.wago.com/770-131)



**Item no.: 770-101**

Locking lever; for flying leads; for manual operation; black

[www.wago.com/770-101](http://www.wago.com/770-101)



**Item no.: 770-111**

Locking lever; for flying leads; for tool operation; black

[www.wago.com/770-111](http://www.wago.com/770-111)

## Optional accessories

### Marking accessories

#### Marker



**Item no.: 770-450/000-002**

Marker card; Plastic; yellow

[www.wago.com/770-450/000-002](http://www.wago.com/770-450/000-002)



**Item no.: 770-450/000-001**

Marker card; Plastic; green

[www.wago.com/770-450/000-001](http://www.wago.com/770-450/000-001)



**Item no.: 770-450/000-005**

Marker card; Plastic; red

[www.wago.com/770-450/000-005](http://www.wago.com/770-450/000-005)



**Item no.: 770-450**

Marker card; Plastic; white

[www.wago.com/770-450](http://www.wago.com/770-450)



**Item no.: 770-450/000-006**

Marker card; Plastic; blue

[www.wago.com/770-450/000-006](http://www.wago.com/770-450/000-006)



**Item no.: 770-450/000-012**

Marker card; Plastic; orange

[www.wago.com/770-450/000-012](http://www.wago.com/770-450/000-012)

### Tool

#### Operating tool

Subject to changes. Please also observe the further product documentation!

WAGO GmbH & Co. KG

Hansastr. 27

32423 Minden

Phone: +49571 887-0 | Fax: +49571 887-169

Email: [info.de@wago.com](mailto:info.de@wago.com) | Web: [www.wago.com](http://www.wago.com)

Do you have any questions about our products?

We are always happy to take your call at +49 (571) 887-44222.





**Item no.: 210-719**  
Operating tool; Blade: 2.5 x 0.4 mm; with a partially insulated shaft

[www.wago.com/210-719](http://www.wago.com/210-719)

### Mounting

Snap-in frame



**Item no.: 770-319**  
Snap-in frame; 4-pole; 1.0 ... 3.0 mm; black

[www.wago.com/770-319](http://www.wago.com/770-319)



**Item no.: 770-339**  
Snap-in frame; 4-pole; 1.0 ... 3.0 mm; black

[www.wago.com/770-339](http://www.wago.com/770-339)

### Cover

Cover



**Item no.: 770-201**  
Lockout cap; 12-pole, separable; for sockets; Plastic; black

[www.wago.com/770-201](http://www.wago.com/770-201)



**Item no.: 770-221**  
Lockout cap; 12-pole, separable; for sockets; Plastic; white

[www.wago.com/770-221](http://www.wago.com/770-221)



**Item no.: 897-2005**  
Protective cap; Type4; for sockets and plugs; PVC; red

[www.wago.com/897-2005](http://www.wago.com/897-2005)

### Downloads

#### Documentation

##### Bid Text

Item no.	Date	File Name	Format	Size	Action
770-244	2019 Feb 19	X81 - Datei	xml	3.0 kB	<a href="#">Download</a>
770-244	2015 Jun 8	doc - Datei	doc	24.6 kB	<a href="#">Download</a>

#### CAD/CAE-Data

##### CAD data

Item no.	URL	Action
2D/3D Models 770-244	<a href="#">URL</a>	<a href="#">Download</a>

Subject to changes. Please also observe the further product documentation!

## CAE data

WSCAD Universe 770-244	<a href="#">URL</a>	<a href="#">Download</a>
ZUKEN Portal 770-244	<a href="#">URL</a>	<a href="#">Download</a>
EPLAN Data Portal 770-244	<a href="#">URL</a>	<a href="#">Download</a>

## Environmental Product Compliance

### Compliance Search

Environmental Product Compliance 770-244	<a href="#">URL</a>	<a href="#">Download</a>
Socket; 4-pole; Cod. B; 4,00 mm <sup>2</sup> ; gray		

## Installation Notes

### Conductor termination

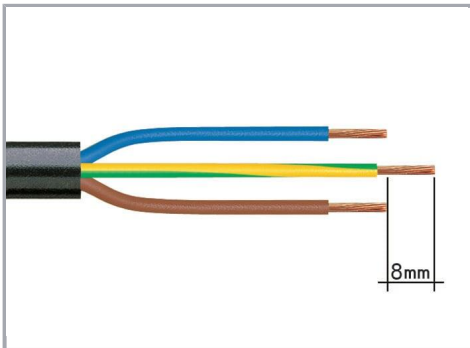

1. Strip length, outer insulation = 35 mm (2-pole), 55 mm (3- to 5-pole)

2. Strip length = 9 mm

3. Extended ground conductor = 8 mm

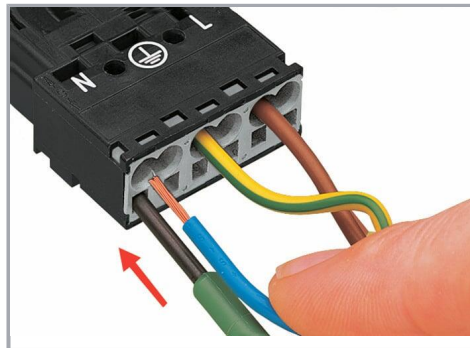

To terminate fine-stranded conductors, open the clamping unit via screwdriver (2.5 mm blade width) and insert a stripped conductor until it hits the backstop.

Subject to changes. Please also observe the further product documentation!

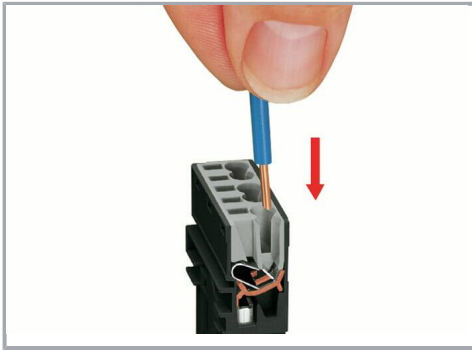

Insert the stripped solid conductor until it hits the backstop.

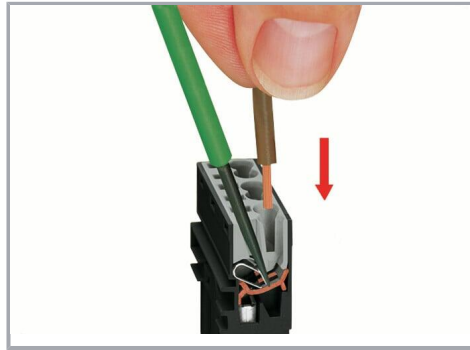

To terminate fine-stranded conductors, open the clamping unit via screwdriver (2.5 mm blade width) and insert a stripped conductor until it hits the backstop.

#### Conductor removal

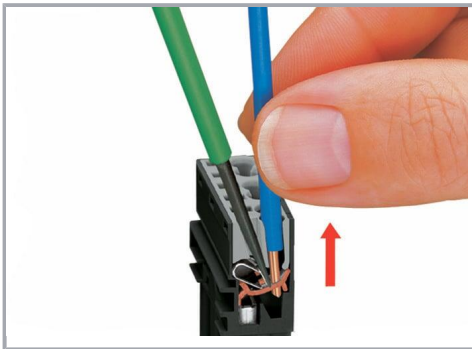

To remove the conductor, actuate the clamp via screwdriver (2.5 mm blade width) and pull out the conductor.

#### Installation

Subject to changes. Please also observe the further product documentation!

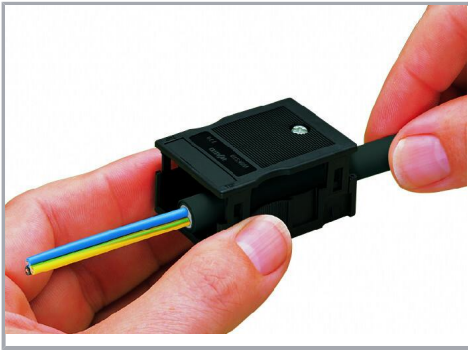

We recommend pulling the pre-latched strain relief housing over the cable prior to termination. However, the strain relief can be mounted at a later time as well.

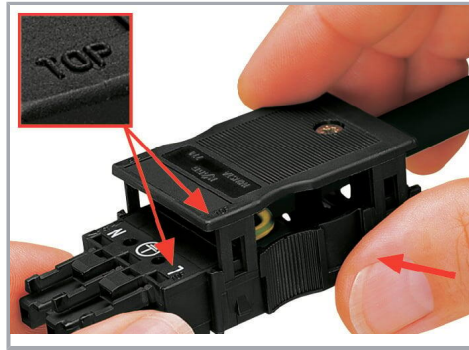

Latch the strain relief housing onto the plug /socket. Note the "TOP" inscription.

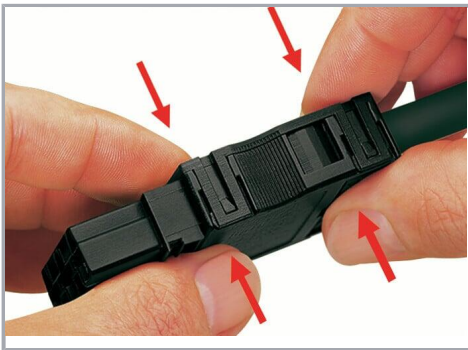

Prepare strain relief housing by snapping together upper and bottom part.



Tighten strain relief screw with screwdriver (2.5 mm blade width).

### Coding



Simply cut off the coding pin from the socket.

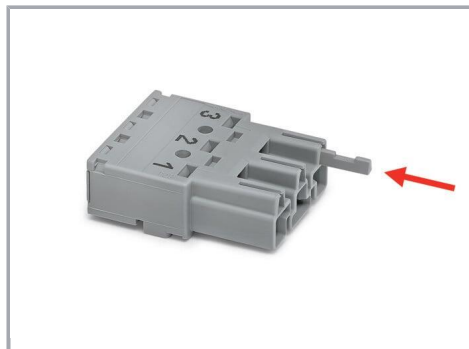

Insert coding pin into plug (break first) until it engages.

Subject to changes. Please also observe the further product documentation!

### Mismatching protection

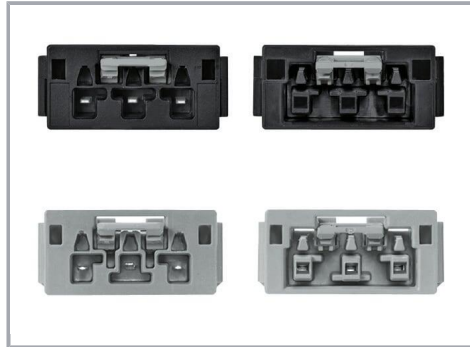
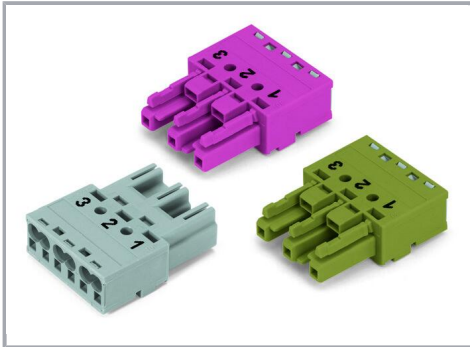

B-coded connectors with different colors can be plugged together.

Important note:

Different colors and/or pole markings are used for circuit identification.

Only connectors of the same color and same pole marking must be plugged together.

B-coded connectors (shown in gray) not only differ in color, but also in their design, making them incompatible with other coded connectors.



Easy circuit identification via different marking and colors

### Product family

**WINSTA® MIDI**

[Show all products from the family](#)

Subject to changes. Please also observe the further product documentation!