

# AO320-CC Ultra Stable, Low Noise OCXO



2111 Comprehensive Drive  
Aurora, Illinois 60505  
Phone: 630-851-4722  
Fax: 630-851-5040  
[www.conwin.com](http://www.conwin.com)

## Description:

Connor-Winfield's Series AO320-CC is a high precision Enhanced Oven Compensated Crystal Oscillator (OCXO) housed in a small 22x25.4mm surface mount package. The AO320-CC Series provides thermal stability of less than  $\pm 1$ ppb, excellent short term stability and very low phase noise. This oscillator is designed for synchronizing high end audio equipment that demands the highest precision available.



## Features:

- Output Frequency: 25.0MHz
- 3.3 Vdc Operation
- 22 x 25.4 mm SMT Package
- Frequency Stabilities:  $\pm 1$ ppb
- Temperature Range: -40 to 85°C
- LVCMOS Output Levels
- Grounded Metal Cover
- Adapter board for 26x36mm pinned version available
- RoHS Compliant / Lead Free

## Absolute Maximum Ratings

Parameter	Minimum	Nominal	Maximum	Units	Notes
Storage Temperature	-55	-	105	°C	
Supply Voltage (Vcc)	-0.5	-	3.6	Vdc	
Operating Supply Voltage 3.3V	3.135	3.30	3.465	Vdc	

Absolute Ratings: Stresses beyond those listed under "absolute maximum ratings" may cause permanent damage to the device. These are stress ratings only. The functional operation of the device at those or any other conditions beyond those indicated under "recommended operating conditions" is not implied. Exposure to conditions outside the "recommended operating conditions" for any extended period of time may adversely impact device reliability and result in failures not covered by warranty.

## Operating Specifications

Parameter	Minimum	Nominal	Maximum	Units	Notes
Center Frequency (Fo)		25.0		MHz	
Operating Temperature					
Option 6	-40	-	85	°C	
Frequency Calibration @ 25°C	-200	-	200	ppb	
Frequency Stability vs. Temperature					
Option 01	-1.0	-	1.0	ppb	1
Frequency vs. Supply Voltage	-2.0	-	2.0	ppb	Vcc $\pm$ 1%
Frequency vs. Load	-2.0	-	2.0	ppb	Vcc $\pm$ 1%
Aging: Daily	-0.5	-	0.5	ppb/day	2
Aging: First Year	-50	-	50	ppb	
Lifetime Tolerance: (20 years)	-400	-	400	ppb	3
Supply Voltage (Vcc)					
Option 03	3.135	3.30	3.465	Vdc	4
Power Consumption:					
Steady State, @ 25°C, 3.3Vdc	-	-	1.5	W	5
Turn On 3.3Vdc	-	-	3.6	W	5
Phase Jitter: (BW: 12kHz to 1MHz)	-	-	0.2	ps rms	
Allan Deviation (Tau=10s)	-	5.0E-12	-		
Start-Up Time:	-	-	500	ms	
Warm Up Time: @ 25°C	-	-	5	minutes	6

## Notes:

1. Frequency stability is based on (Fmax-Fmin)/2.
2. At time of shipment after 48 hours of operation.
3. Inclusive of Calibration, Operating Temperature, Supply Voltage change, Load change, and 10 Year Aging.
4. Supply voltage must reach Vcc levels monotonically within a ramp-up time of <12 ms.
5. Measured with Vcc = Nominal in calm air.
6. Measured @ 25°C, within  $\pm 100$  ppb, referenced one hour after turn-on.



Bulletin **Cx315**  
Page **1 of 5**  
Revision **00**  
Date **31 Aug 2021**



## Phase Noise

Parameter	Minimum	Nominal	Maximum	Units	Notes
SSB Phase Noise at 1Hz offset	-	-87	-	dBc/Hz	
SSB Phase Noise at 10Hz offset	-	-115	-	dBc/Hz	
SSB Phase Noise at 100Hz offset	-	-136	-	dBc/Hz	
SSB Phase Noise at 1KHz offset	-	-145	-	dBc/Hz	
SSB Phase Noise at 10KHz offset	-	-151	-	dBc/Hz	
SSB Phase Noise at 100KHz offset	-	-155	-	dBc/Hz	

## CMOS Output Characteristics

Parameter	Minimum	Nominal	Maximum	Units	Notes
Load	-	15	-	pF	
Output Voltage: High (Voh)	3.0	-	-	V	
Output Voltage: Low (Vol)	-	-	0.4	V	
Output Current: High (Ioh)	-0.4	-	-	mA	
Output Current: Low (Iol)	-	-	0.4	mA	
Duty Cycle at 50% of Vcc	45	50	55	%	
Rise / Fall Time: 10% to 90%	-	-	6	ns	
Spurious Output	-	-	-80	dBc	

## Re-Stabilization Time

Off Time	Re stabilization Time
<1 Hour	<2 Hours *
<6 Hour	<12 Hours *
<24 Hour	<48 Hours *
1 to 16 Days	48 Hours + 1/4 Off Time *
>16 Days	<6 Days *

\* For a given off time, the time required to meet daily aging, short term stability requirements.

## Environmental Characteristics

Shock	500 G's 1ms, Halfsine, 3 shocks per direction, per MIL-STD 202G, Method 213B Test Condition D.
Sinusoidal Vibration	0.06" D.A. or 10G's Peak, 10 to 500 Hz, per MIL-STD-202G, Method 204D, Test Condition A.
Random Vibration	5.35 G's rms. 20 to 2000 Hz per MIL-STD-202G, Method 214, Test Condition 1A, 15 minutes each axis.
Moisture	10 cycles, 95% RH, Per MIL-STD-202G, Method 112.
Marking Permanency	Per MIL-STD-202G, Method 215J.
Solder Process Recommendations:	RoHS compliant, lead free. See solder profile on page 5.
In-line reflow:	Refer to recommended reflow pre-heat and reflow temperatures on page 5. Package material consists of metal cover with FR4 substrate. Component solder is Pb-free high temperature eutectic alloy with melting point of 221°C.
In-line oven profile:	We recommend using KIC profiler or similar device placing one of the thermocouples on the device to insure that the internal package temperature does not exceed 221°C.
Removal of device:	If for any reason the device needs to be removed from the board, use a temperature controlled repair station with profile monitoring capabilities. Following a monitored profile will insure the device is properly pre-heated prior to reflow. Refer to IPC 610E for inspection guidelines.
Recommended Cleaning Process:	(If required) Device is non-hermetic, water resistance with four weep holes, one in each corner to allow moisture to be removed during the drying cycle. We recommend in-line warm water wash with air knife and drying capabilities. If cleaner does not have drying capability, then use hot air circulated oven. Boards should be placed in the oven vertically for good water runoff <b>Device must be dried properly prior to use!</b>
Note:	If saponifier is used make sure the device is rinsed properly to insure all residues are removed. PH of saponifier should not exceed 10.
Drying Temperature:	Between 85 to 100°C.
Drying Time:	Time will vary depending on the board size.

**Caution: Do not submerge the device!**

Bulletin	Cx315
Page	2 of 5
Revision	00
Date	31 Aug 2021

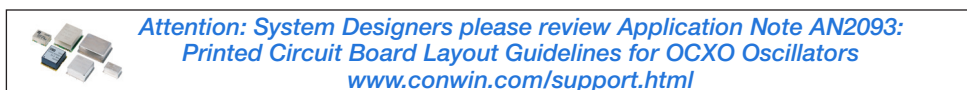

## Package Characteristics

AO320 Package

Package consists of a hermetic metal package OCXO mounted to an FR4 substrate surrounded by a non-hermetic metal cover (airflow shield)

## Ordering Information

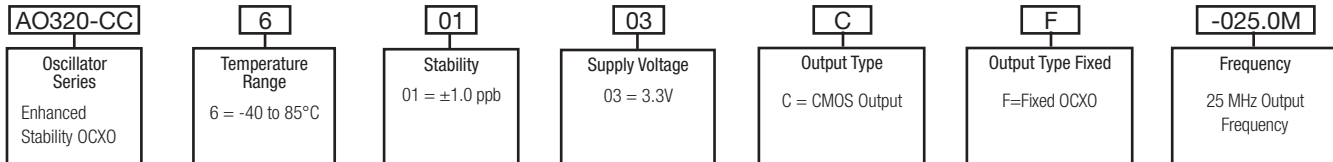

Part Number Example: AO320-CC-60103CF-025.0M

## Package Outline

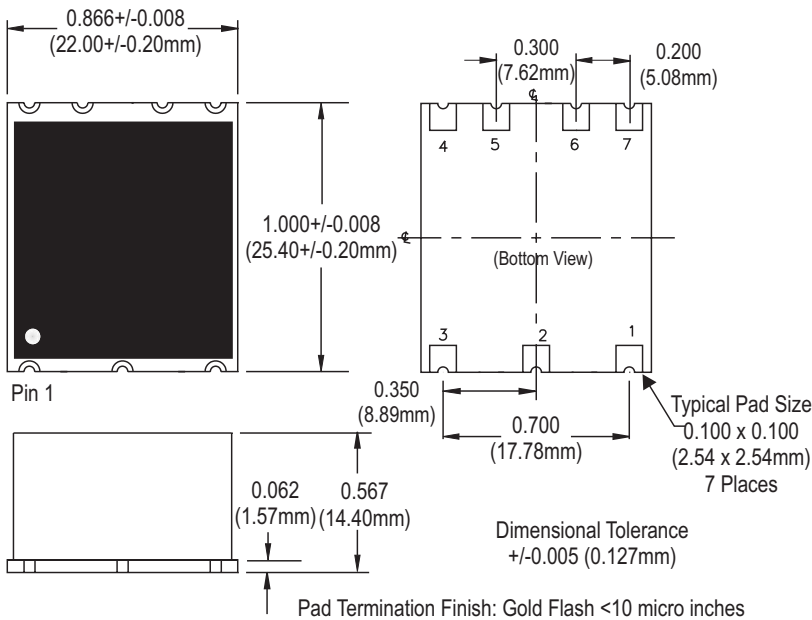

## Suggested Pad Layout

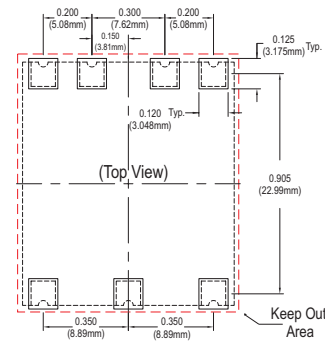

\* Do not route any traces in the keep out area. It is recommended the next layer under the keep out area is to be ground plane.

## Marking Information

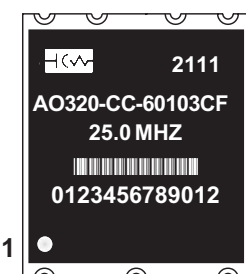

Date Code (YYWW)

Model Number

Output Frequency

Serial # Barcode

Serial Number

## Pad Connections

Pad	Connection
1:	N/C
2:	Do not Connect
3:	Supply Voltage (Vcc)
4:	RF Output
5:	Do Not Connect
6:	Do Not Connect
7:	Ground

DO NOT connect "DNC" pads to ground or supply rails.

**Attention: System Designers please review Application Note AN2093:  
Printed Circuit Board Layout Guidelines for OCXO Oscillators**  
[www.conwin.com/support.html](http://www.conwin.com/support.html)

Bulletin	Cx315
Page	3 of 5
Revision	00
Date	31 Aug 2021

## Test Circuit - CMOS Output

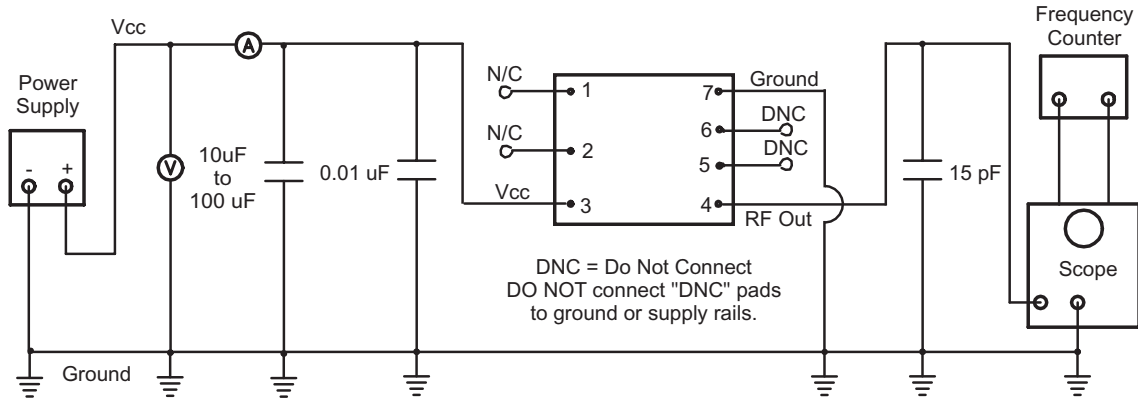

## Frequency Stability Plot over Temperature

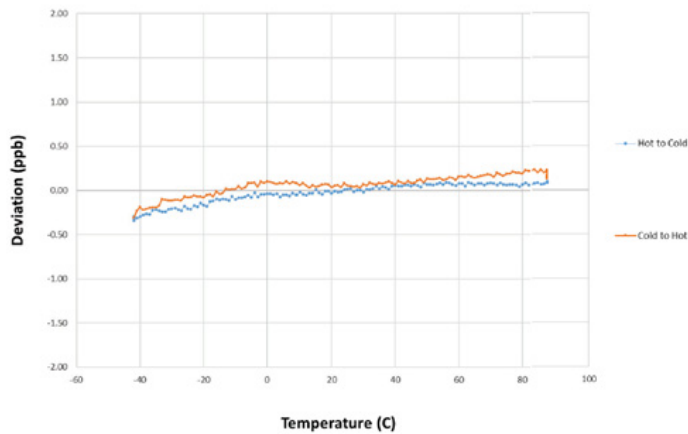

## Solder Profile

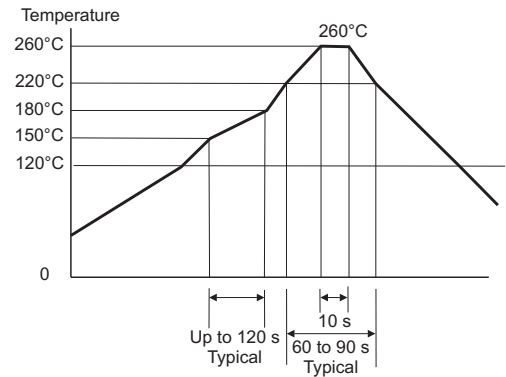

Meets IPC/JEDEC J-STD-020C

 **Attention: System Designers please review Application Note AN2093: Printed Circuit Board Layout Guidelines for OCXO Oscillators**  
[www.conwin.com/support.html](http://www.conwin.com/support.html)

Bulletin	Cx315
Page	4 of 5
Revision	00
Date	31 Aug 2021

## ADEV Plot

Allan Deviation  $\sigma_y(\tau)$



## TDEV & MTIE 4-Day Stability Measurement Through HPF (1MHz)

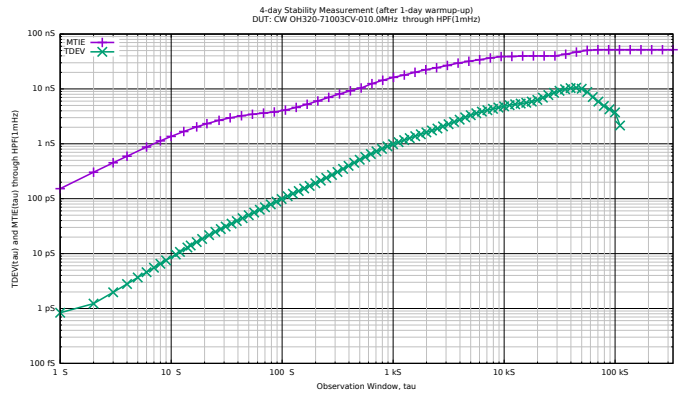

## Revision History

Revision	Date	Changes
00	08/31/21	Initial Release



**Attention: System Designers please review Application Note AN2093: Printed Circuit Board Layout Guidelines for OCXO Oscillators**  
[www.conwin.com/support.html](http://www.conwin.com/support.html)

Bulletin	Cx315
Page	5 of 5
Revision	00
Date	31 Aug 2021