

# APPROVAL SHEET

**WLCM0603TN**  
**Multi-Layer Ceramic**  
**High Frequency High Q Inductors**



\*Contents in this sheet are subject to change without prior notice.

## FEATURES

1. Particular ceramic material and coil structure provide high frequency application range up to 10GHz.
2. Small size and low profile.
3. Available in various sizes.
4. Excellent solderability and heat resistance.

## APPLICATIONS

RF and wireless communication, information technology equipment which includes computer, telecommunications, radar detectors, automotive electronics, cellular phones, pagers, audio equipment, PDAs, keyless remote system and low-voltage power supply modules.

## SHAPE and DIMENSION

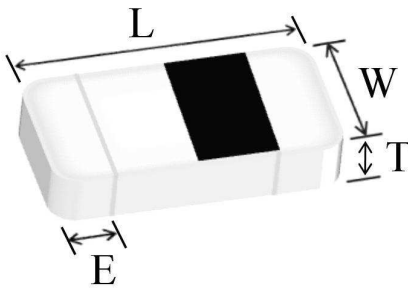

Unit: mm

WLCM Series	L	W	T	E (Min/Max)	Packing Quantity (pcs/reel)
					Paper Tape
WLCM0603TN (EIA 0201)	0.60±0.03	0.30±0.03	0.30±0.03	0.10~0.20	15,000

## Ordering Information

WL	CM	0603	TN	S	1N2	T	B
<b>Product Code</b>	<b>Series</b>	<b>Dimensions</b>	<b>Series extension</b>	<b>Tolerance</b>	<b>Value</b>	<b>Packing Code</b>	
WL: Inductor	Ceramic multilayer inductor.	0603:EIA 0201	TN: Freq. 500 MHz	B: ± 0.1nH C: ± 0.2nH H: ± 3% J: ± 5%	1N2 =1.2nH 12N=12nH R10=100nH =0.10uH	T=7" Reeled (Paper tape)	B:STD

## Electrical Characteristics

- WLCM0603TN series (EIA 0201)

Operating Temperature range: -55°C to 125°C

Walsin Part Number	L(nH)	Tolerance	Q Min	Typical Q @ Frequency (MHz)	SRF (MHz)	RDC (Ω)	Rated Current (mA) Max.
					Min.	Max.	
WLCM0603TN□0N6TB	0.6	B, C	14	500	20,000	0.07	850
WLCM0603TN□0N7TB	0.7	B, C	14	500	20,000	0.08	800
WLCM0603TN□0N8TB	0.8	B, C	14	500	18,000	0.08	800
WLCM0603TN□0N9TB	0.9	B, C	14	500	18,000	0.10	750
WLCM0603TN□1N0TB	1.0	B, C	14	500	17,000	0.10	750
WLCM0603TN□1N1TB	1.1	B, C	14	500	17,000	0.10	750
WLCM0603TN□1N2TB	1.2	B, C	14	500	17,000	0.10	750
WLCM0603TN□1N3TB	1.3	B, C	14	500	17,000	0.15	600
WLCM0603TN□1N4TB	1.4	B, C	14	500	16,000	0.15	600
WLCM0603TN□1N5TB	1.5	B, C	14	500	15,000	0.15	600
WLCM0603TN□1N6TB	1.6	B, C	14	500	15,000	0.15	600
WLCM0603TN□1N7TB	1.7	B, C	14	500	15,000	0.15	600
WLCM0603TN□1N8TB	1.8	B, C	14	500	15,000	0.15	600
WLCM0603TN□1N9TB	1.9	B, C	14	500	12,500	0.15	600
WLCM0603TN□2N0TB	2.0	B, C	14	500	12,500	0.15	600
WLCM0603TN□2N1TB	2.1	B, C	14	500	11,000	0.15	600
WLCM0603TN□2N2TB	2.2	B, C	14	500	11,000	0.15	600
WLCM0603TN□2N3TB	2.3	B, C	14	500	10,000	0.20	500
WLCM0603TN□2N4TB	2.4	B, C	14	500	10,000	0.20	500
WLCM0603TN□2N5TB	2.5	B, C	14	500	10,000	0.20	500
WLCM0603TN□2N6TB	2.6	B, C	14	500	10,000	0.20	500
WLCM0603TN□2N7TB	2.7	B, C	14	500	10,000	0.20	500
WLCM0603TN□2N8TB	2.8	B, C	14	500	9,500	0.20	500
WLCM0603TN□2N9TB	2.9	B, C	14	500	9,500	0.20	500
WLCM0603TN□3N0TB	3.0	B, C	14	500	9,500	0.25	450
WLCM0603TN□3N1TB	3.1	B, C	14	500	8,000	0.25	450
WLCM0603TN□3N2TB	3.2	B, C	14	500	8,000	0.25	450
WLCM0603TN□3N3TB	3.3	B, C	14	500	8,000	0.25	450
WLCM0603TN□3N4TB	3.4	B, C	14	500	7,000	0.25	450
WLCM0603TN□3N5TB	3.5	B, C	14	500	7,000	0.25	450
WLCM0603TN□3N6TB	3.6	B, C	14	500	6,000	0.30	400
WLCM0603TN□3N7TB	3.7	B, C	14	500	6,000	0.30	400
WLCM0603TN□3N8TB	3.8	B, C	14	500	6,000	0.30	400
WLCM0603TN□3N9TB	3.9	B, C	14	500	5,700	0.30	400
WLCM0603TN□4N0TB	4.0	B, C	14	500	5,300	0.40	350

Walsin Part Number	L(nH)	Tolerance	Q Min	Typical Q @ Frequency (MHz)	SRF (MHz)	RDC ( $\Omega$ )	Rated Current (mA) Max.
					Min.	Max.	
WLCM0603TN□4N1TB	4.1	B, C	14	500	5,300	0.40	350
WLCM0603TN□4N2TB	4.2	B, C	14	500	5,300	0.40	350
WLCM0603TN□4N3TB	4.3	H, J	14	500	5,300	0.40	350
WLCM0603TN□4N7TB	4.7	H, J	14	500	4,400	0.40	350
WLCM0603TN□5N1TB	5.1	H, J	14	500	4,200	0.40	350
WLCM0603TN□5N6TB	5.6	H, J	14	500	4,000	0.40	350
WLCM0603TN□6N2TB	6.2	H, J	14	500	4,000	0.60	300
WLCM0603TN□6N8TB	6.8	H, J	14	500	3,900	0.60	300
WLCM0603TN□7N5TB	7.5	H, J	14	500	3,700	0.60	300
WLCM0603TN□8N2TB	8.2	H, J	14	500	3,600	0.70	250
WLCM0603TN□9N1TB	9.1	H, J	14	500	3,300	0.70	250
WLCM0603TN□10NTB	10	H, J	14	500	3,200	0.70	250
WLCM0603TN□11NTB	11	H, J	14	500	2,900	0.80	250
WLCM0603TN□12NTB	12	H, J	12	500	2,900	0.70	250
WLCM0603TN□13NTB	13	H, J	12	500	2,600	0.80	250
WLCM0603TN□15NTB	15	H, J	12	500	2,600	0.70	250
WLCM0603TN□16NTB	16	H, J	12	500	2,200	0.95	200
WLCM0603TN□18NTB	18	H, J	12	500	2,200	0.80	200
WLCM0603TN□20NTB	20	H, J	12	500	2,200	2.30	150
WLCM0603TN□22NTB	22	H, J	12	500	2,200	1.90	150

## ■ TEST INSTRUMENTS CONDITIONS

Agilent E4991A RF Impedance Material Analyzer or equivalent with fixture 16197A or equivalent

(The residual inductance needs to be compensated : 0.48nH)

Agilent 4338B Milliohm meter

Test Level : 500 mV

## ■ GENERAL TECHNICAL DATA

Operating temperature range : - 55°C ~ +125°C

Storage Condition : Less than 40°C and 70% RH

Storage Time : 6 months Max.

Soldering method : Reflow

## Typical Electrical Characteristic

WLCM0603TN□0N6TB

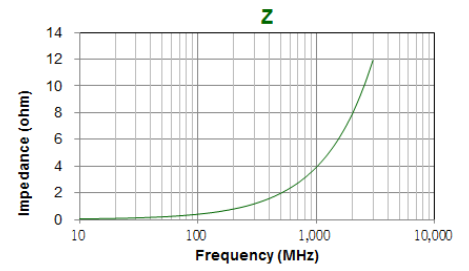
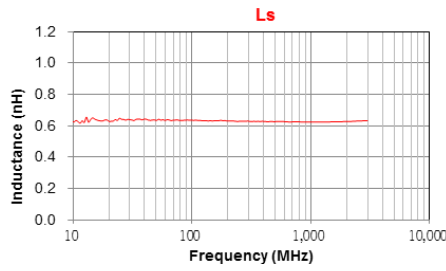
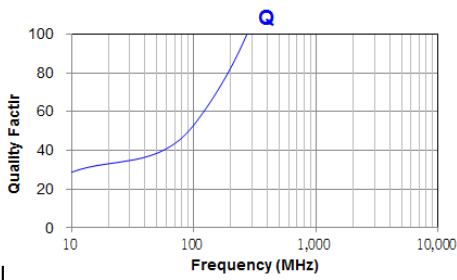

WLCM0603TN□0N7TB

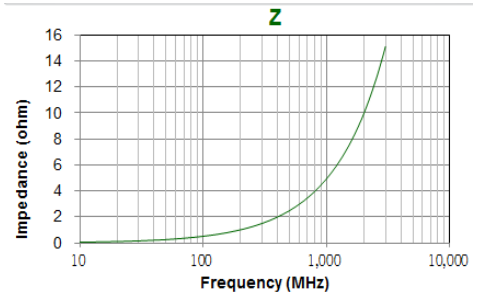
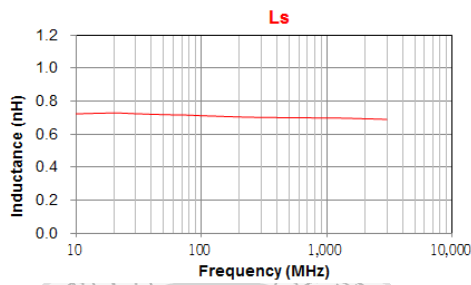
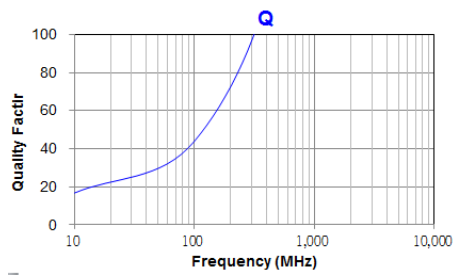

WLCM0603TN□0N8TB

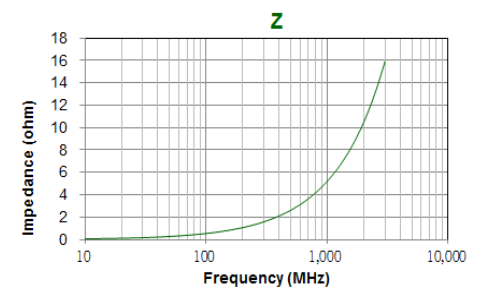
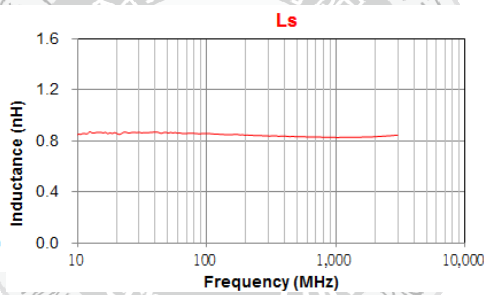
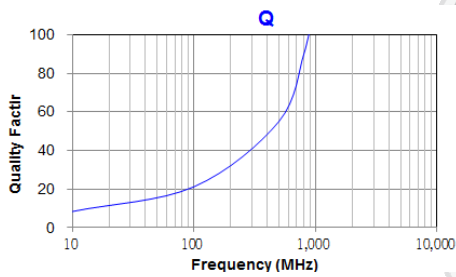

WLCM0603TN□0N9T

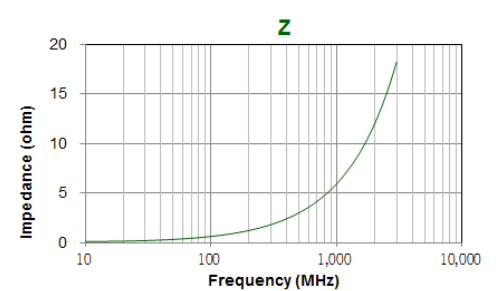
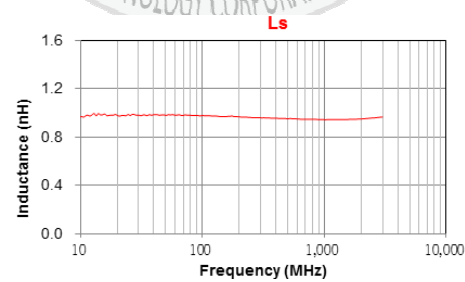
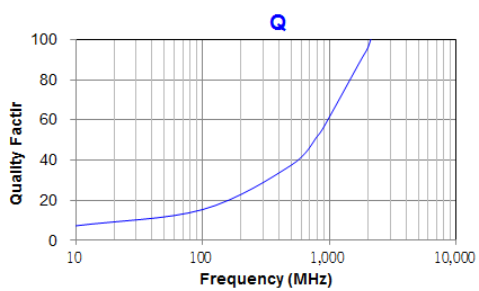

WLCM0603TN□1N0TB

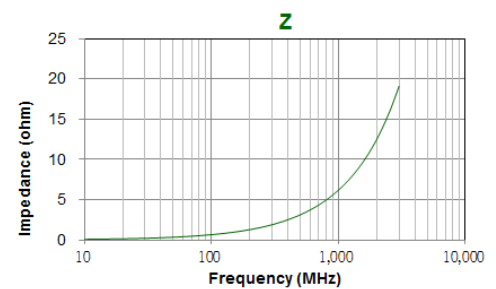
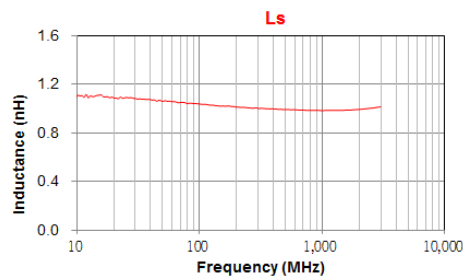
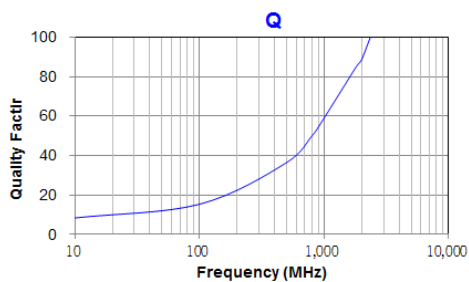

WLCM0603TN□1N1TB

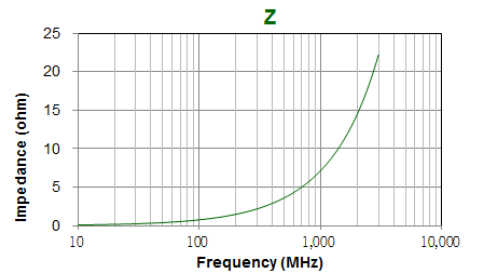
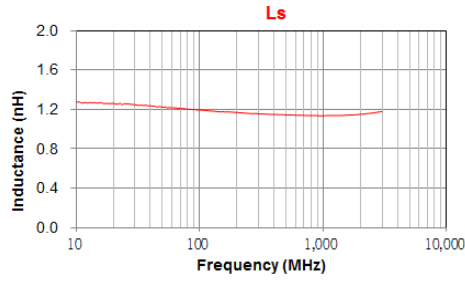
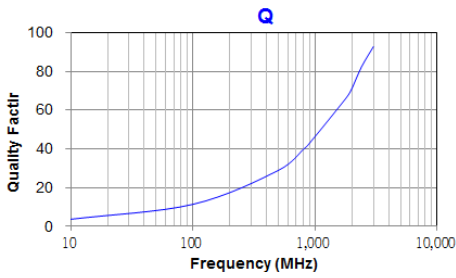

WLCM0603TN□1N2TB

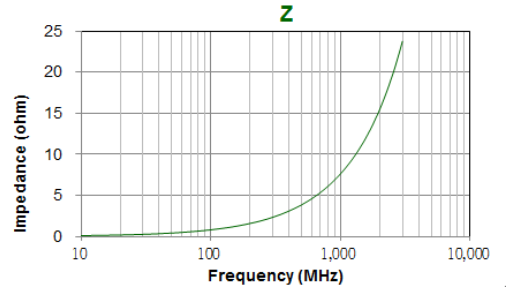
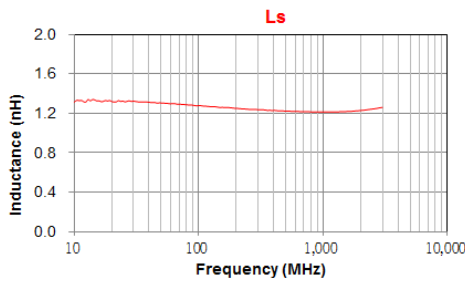
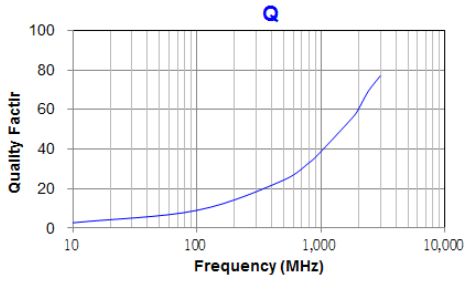

WLCM0603TN□1N3TB

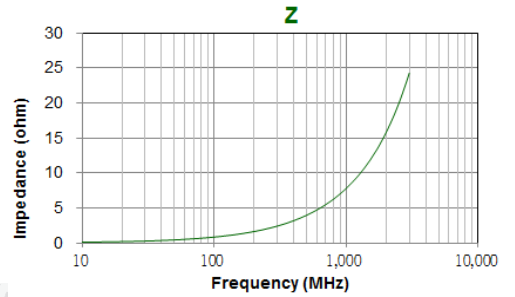
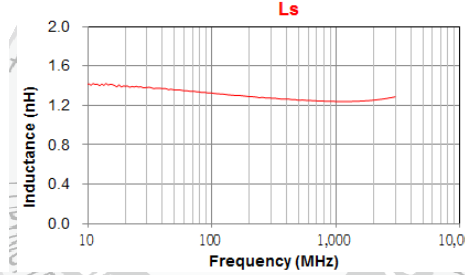
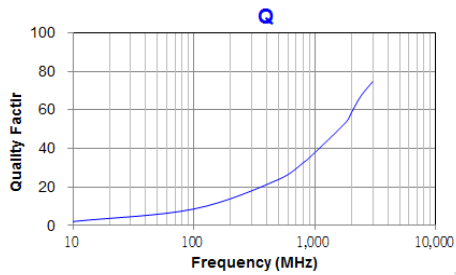

WLCM0603TN□1N4TB

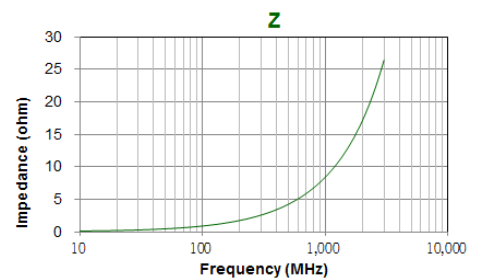
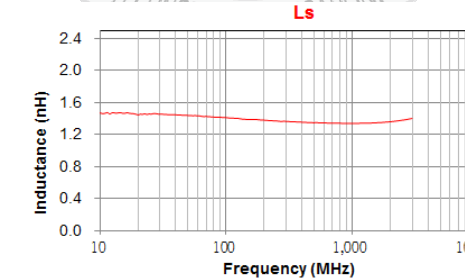
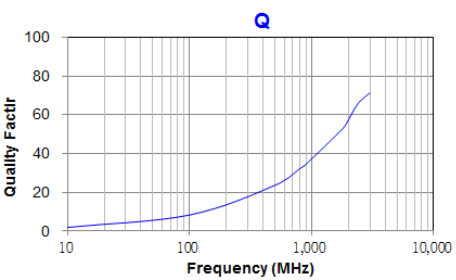

WLCM0603TN□1N5TB

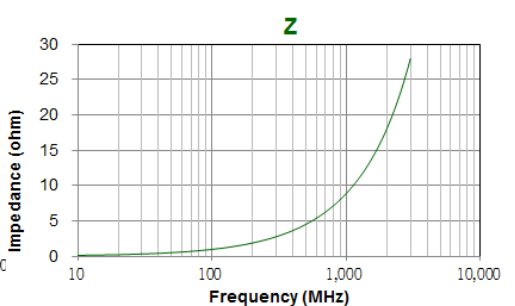
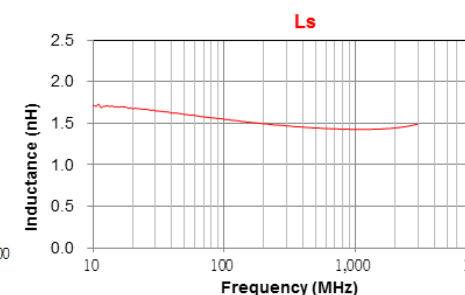
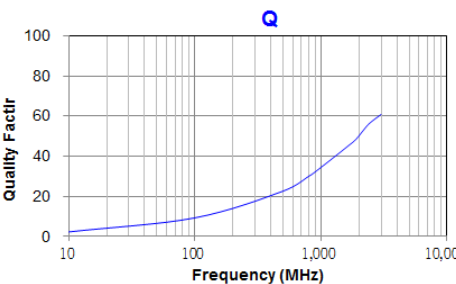

WLCM0603TN□1N6TB

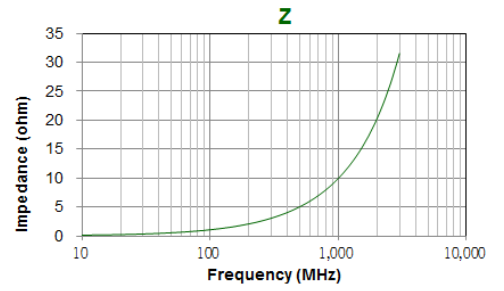
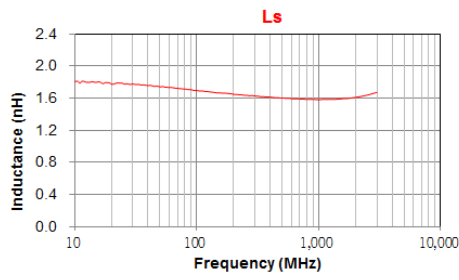
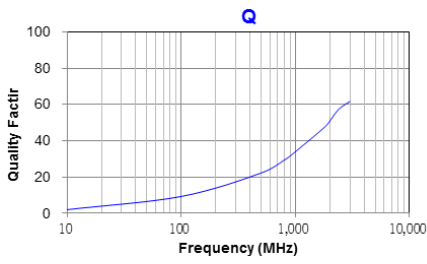

WLCM0603TN□1N7TB

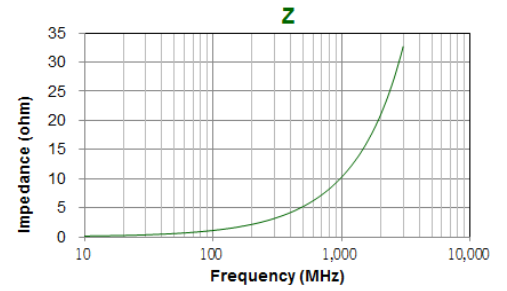
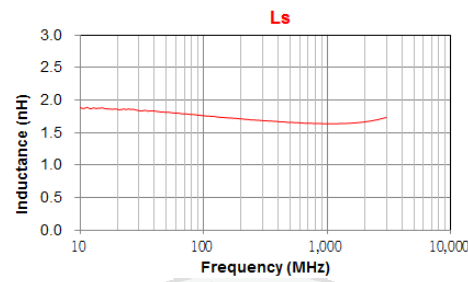
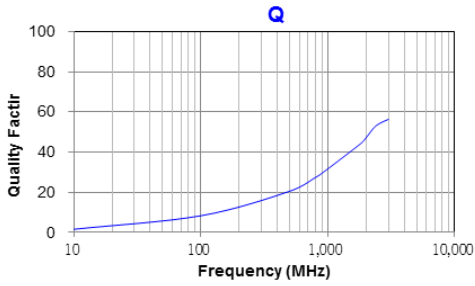

WLCM0603TN□1N8TB

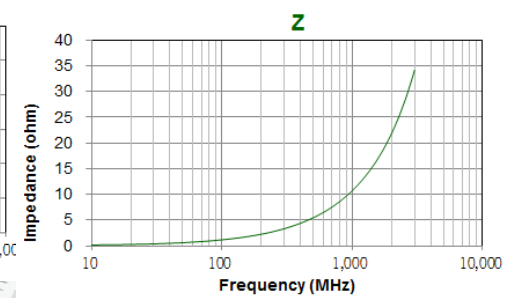
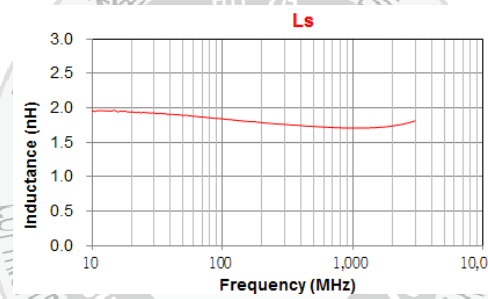
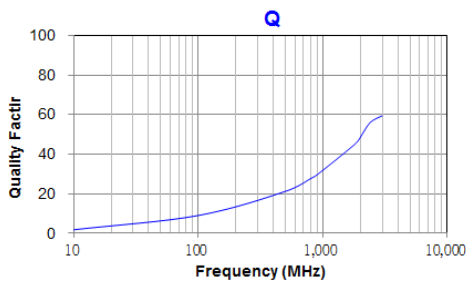

WLCM0603TN□1N9TB

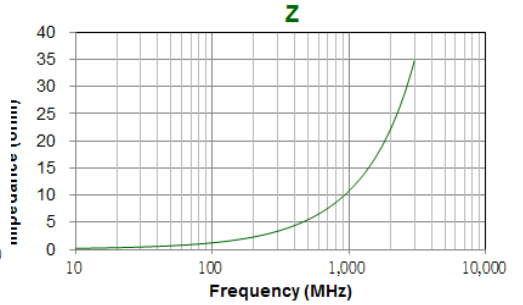
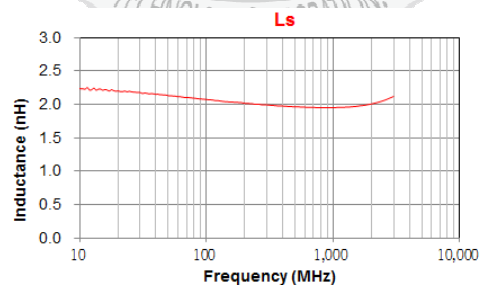
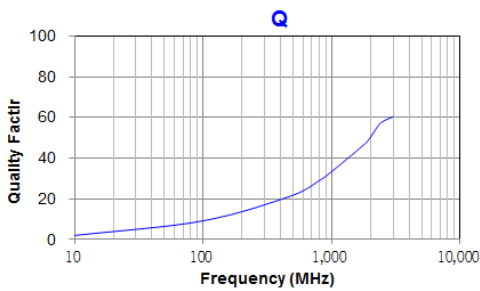

WLCM0603TN□2N0TB

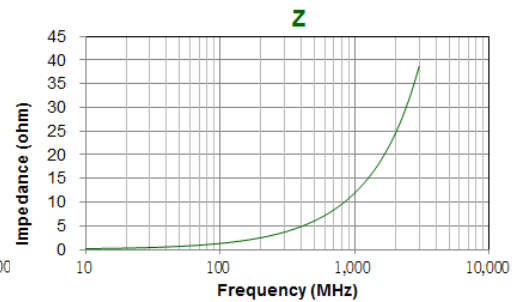
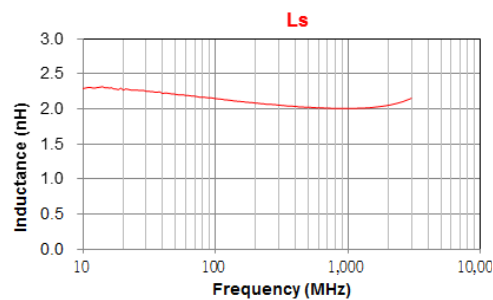
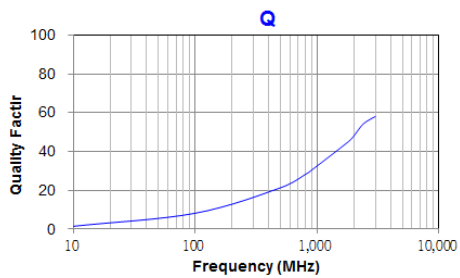

WLCM0603TN□2N1TB

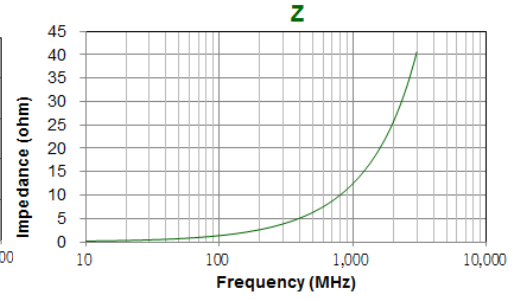
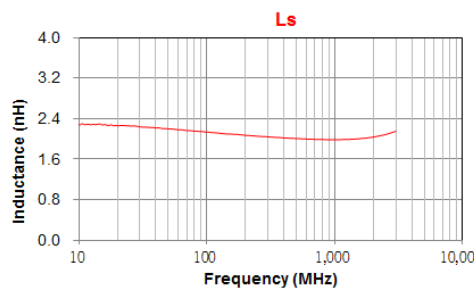
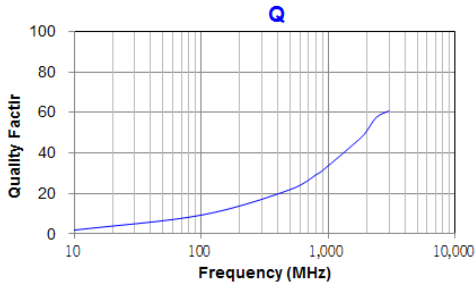

WLCM0603TN□2N2TB

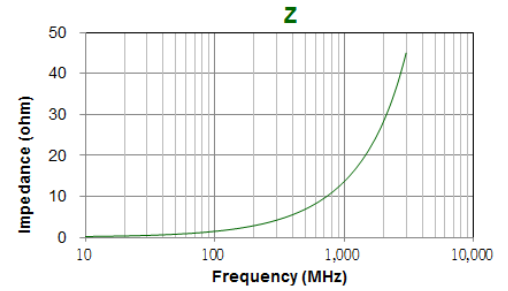
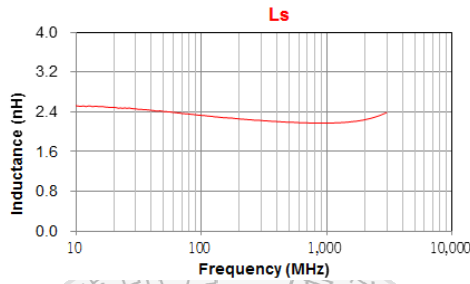
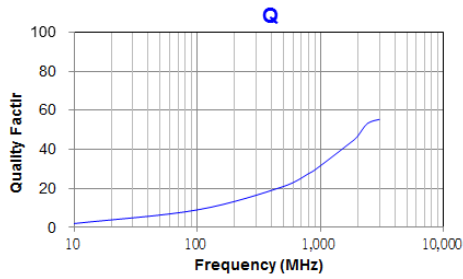

WLCM0603TN□2N3TB

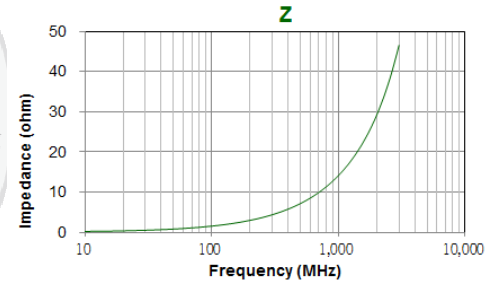
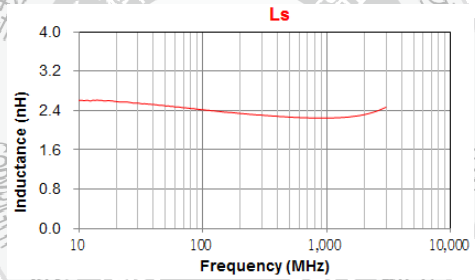
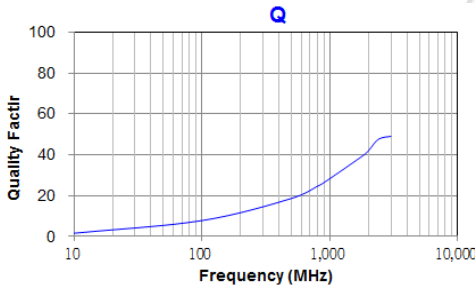

WLCM0603TN□2N4TB

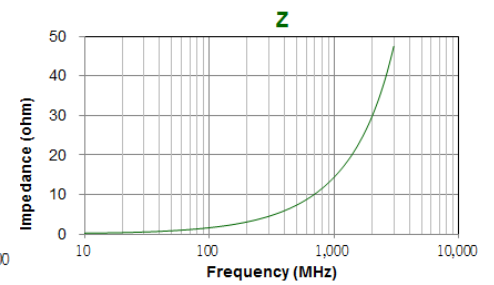
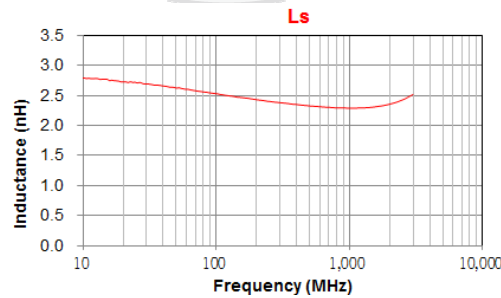
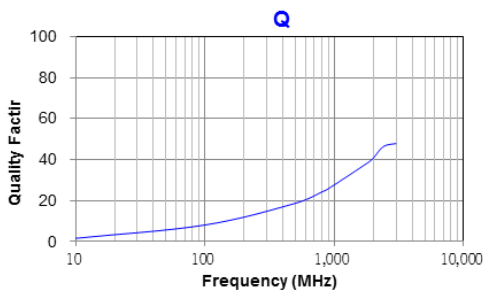

WLCM0603TN□2N5TB

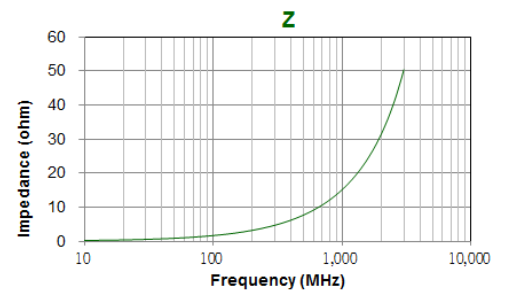
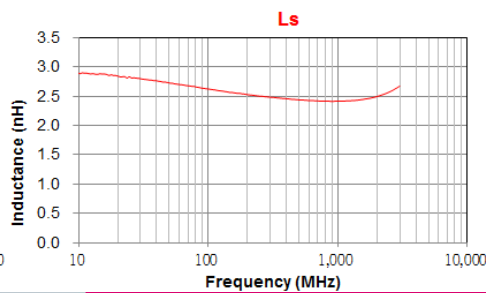
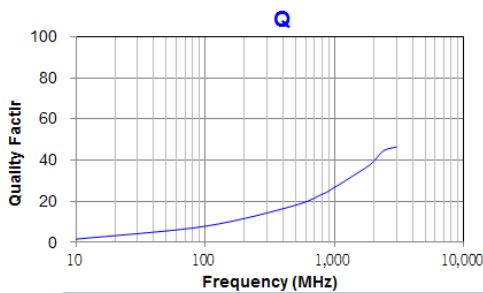



WLCM0603TN□2N6TB

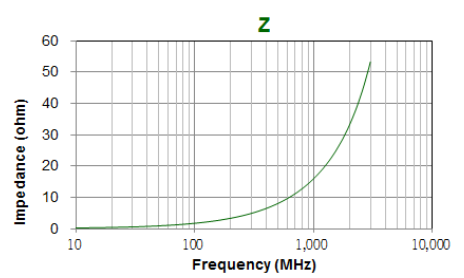
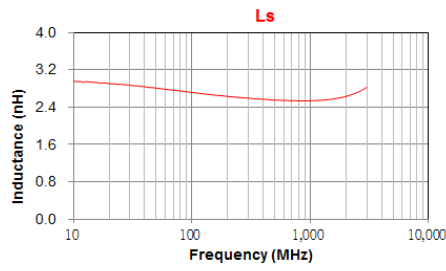
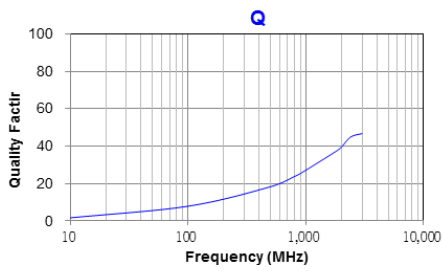

WLCM0603TN□2N7TB

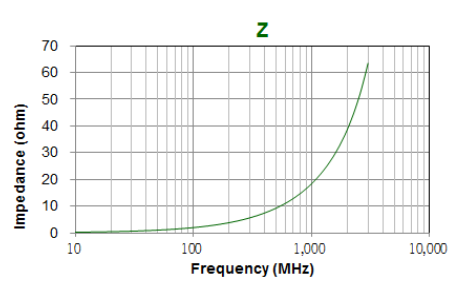
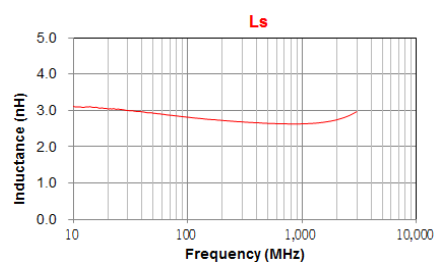
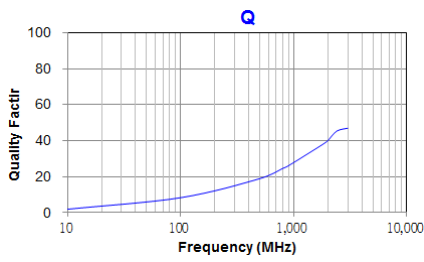

WLCM0603TN□2N8TB

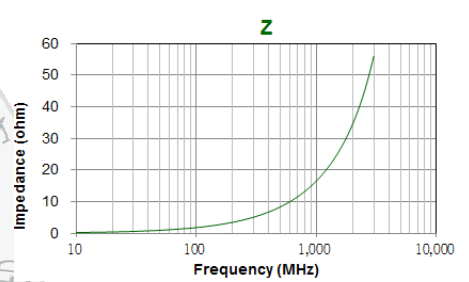
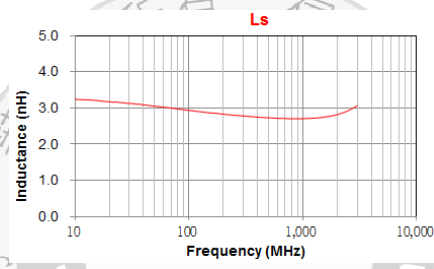
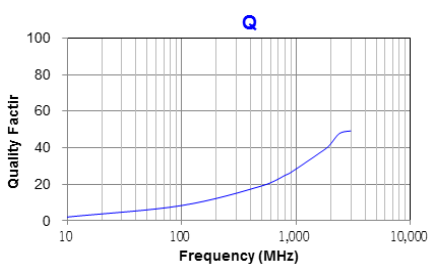

WLCM0603TN□2N9TB

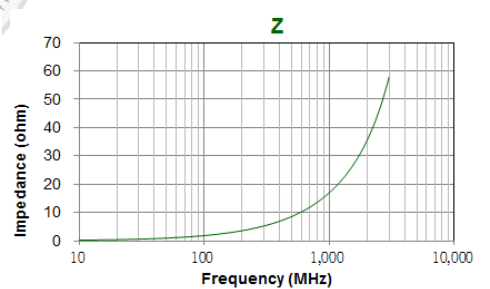
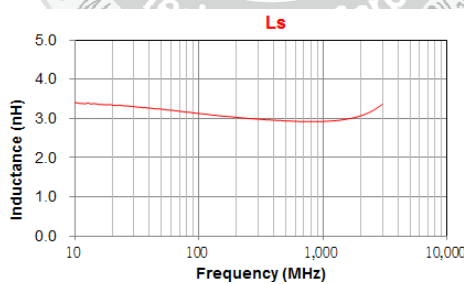
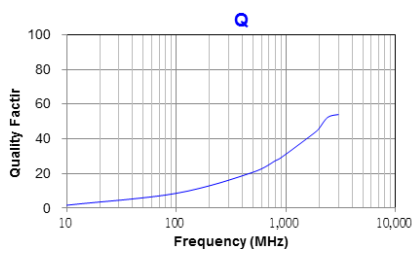

WLCM0603TN□3N0TB

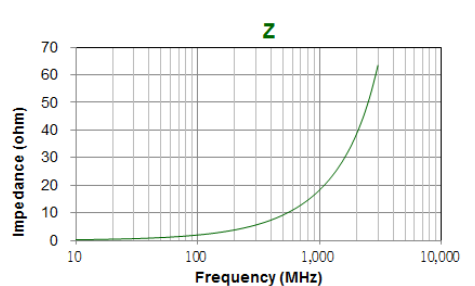
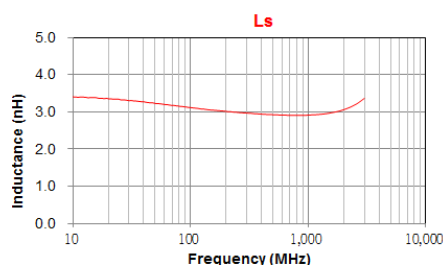
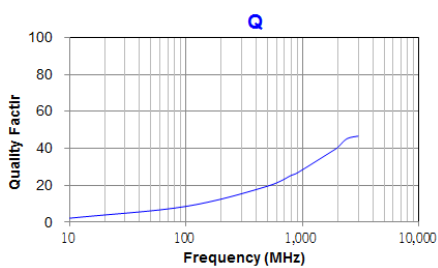

WLCM0603TN□3N1TB

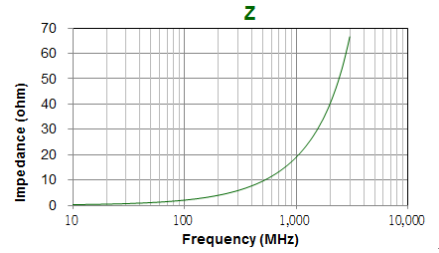
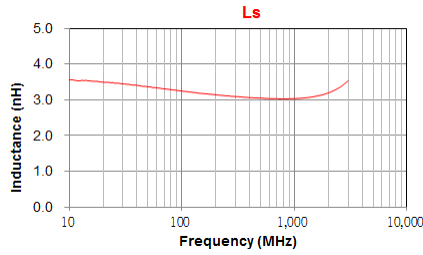
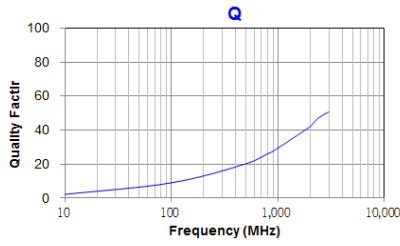

WLCM0603TN□3N2TB

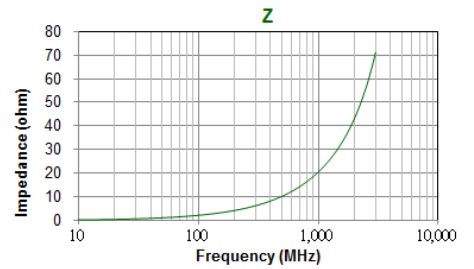
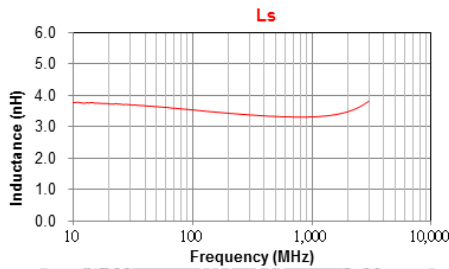
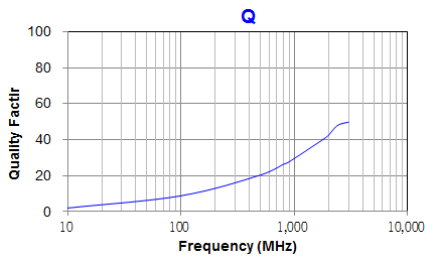

WLCM0603TN□3N3TB

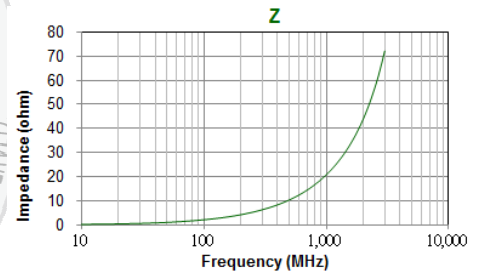
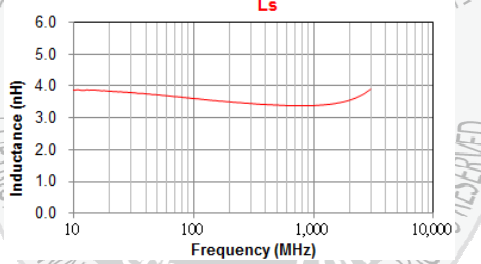
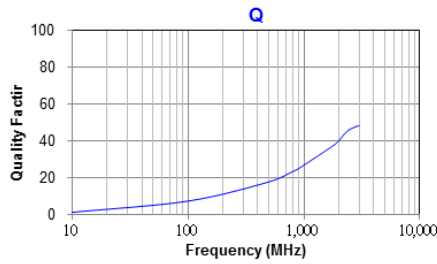

WLCM0603TN□3N4TB

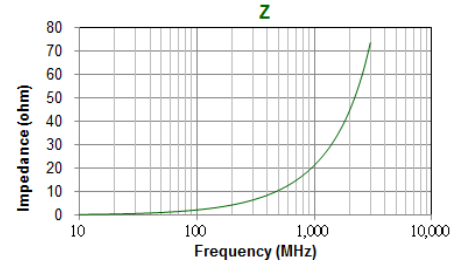
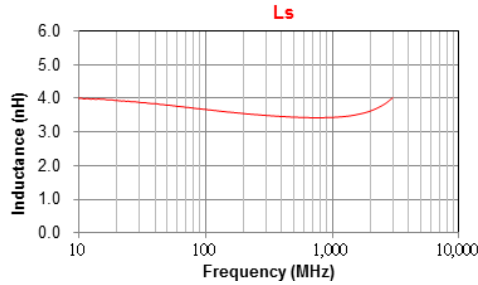
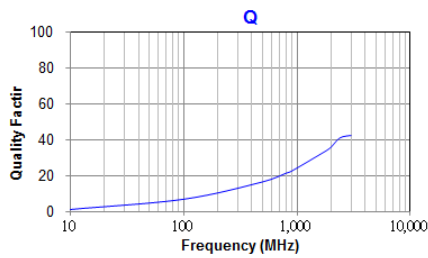

WLCM0603TN□3N5TB

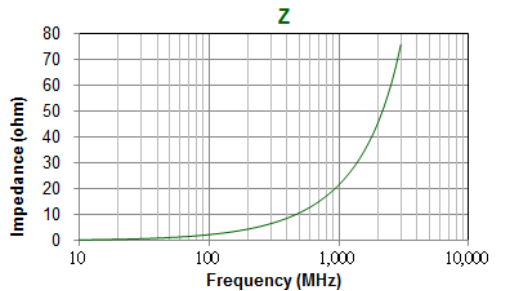
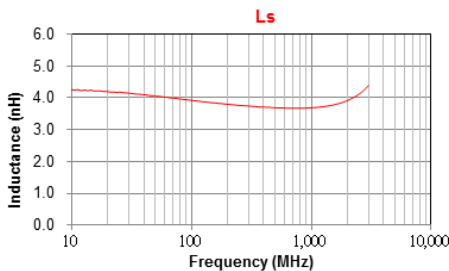
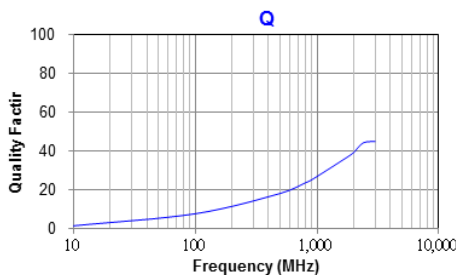

WLCM0603TN□3N6TB

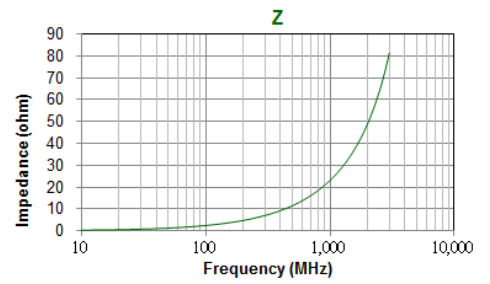
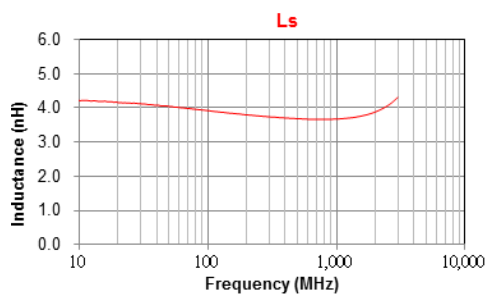
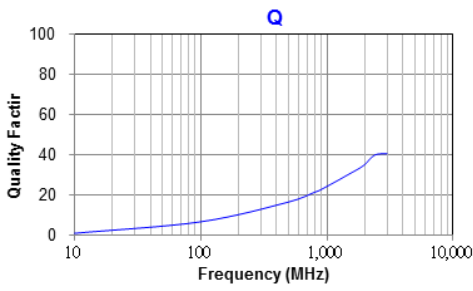

WLCM0603TN□3N7TB

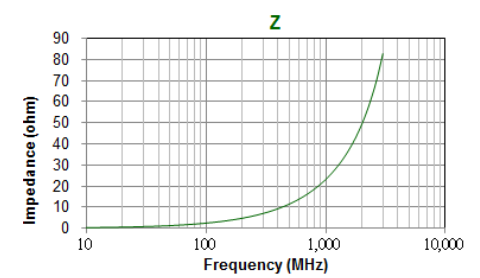
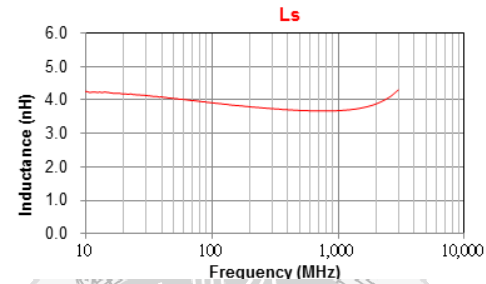
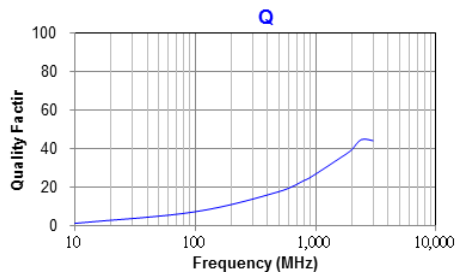

WLCM0603TN□3N8TB

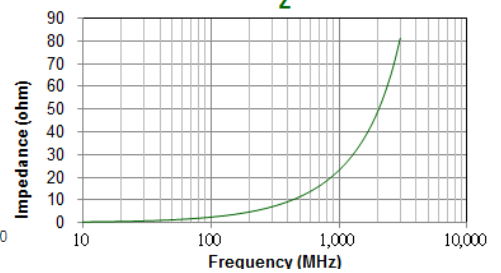
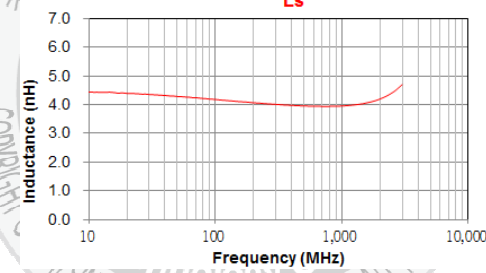
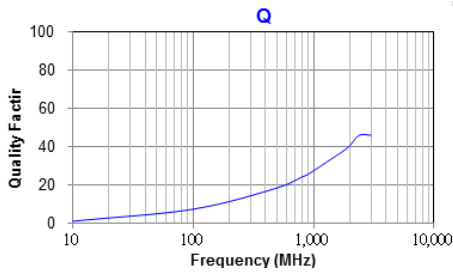

WLCM0603TN□3N9TB

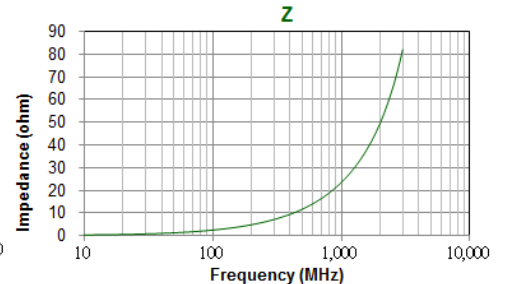
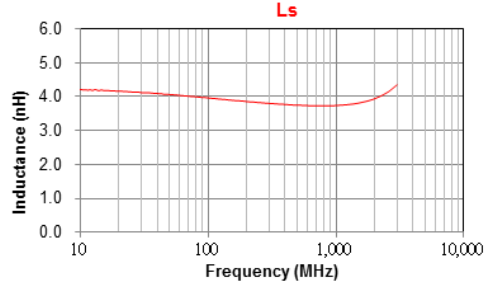
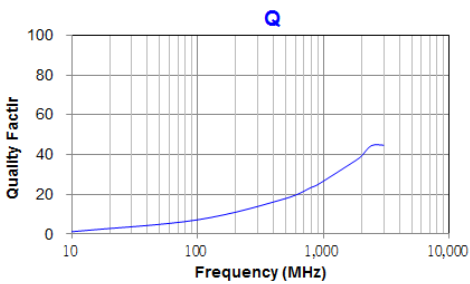

WLCM0603TN□4N0TB

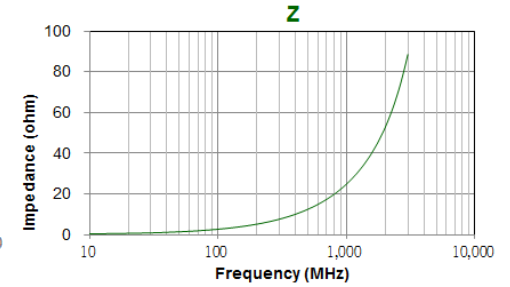
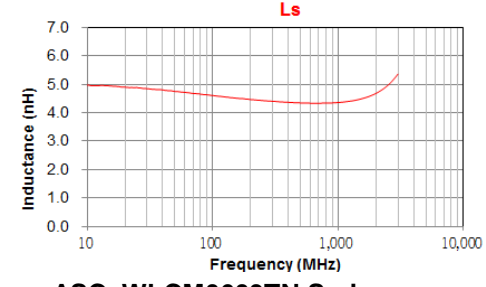
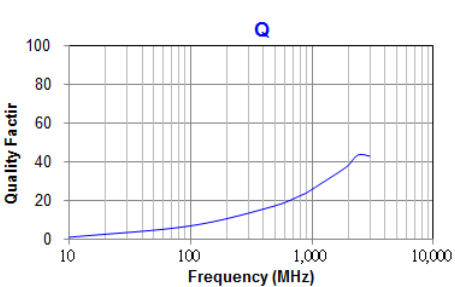

WLCM0603TN□4N1TB

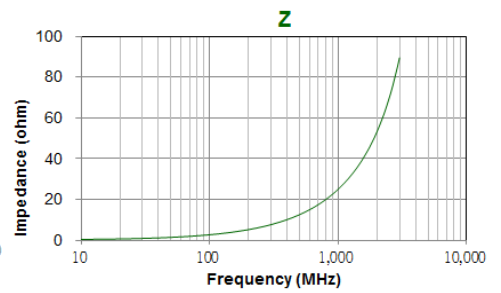
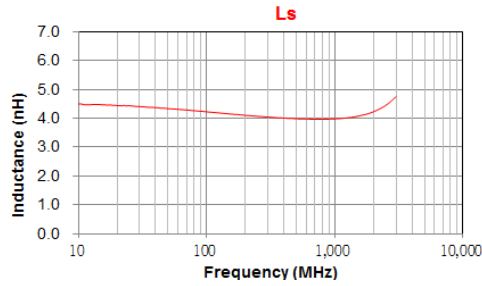
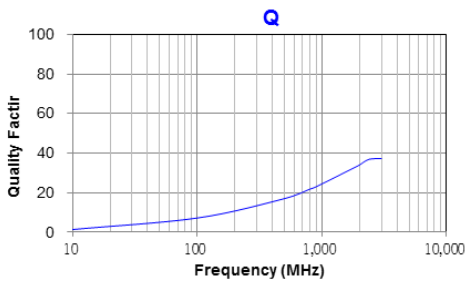

WLCM0603TN□4N2TB

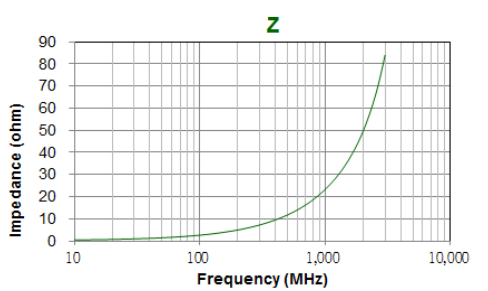
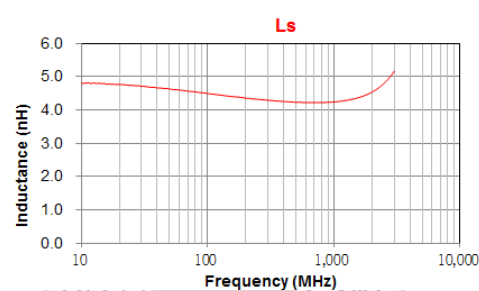
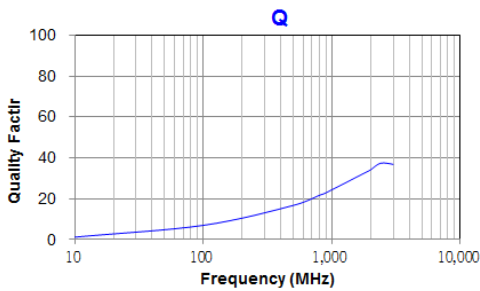

WLCM0603TN□4N3TB

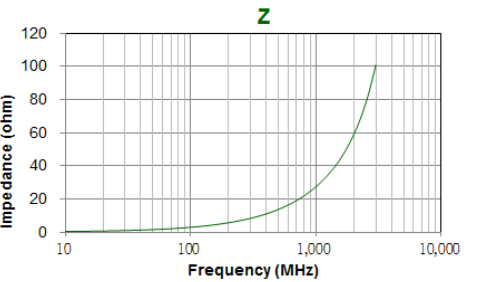
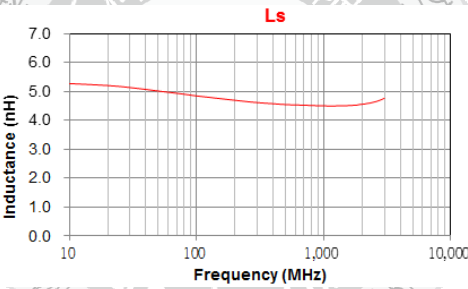
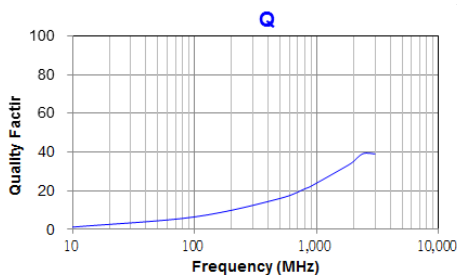

WLCM0603TN□4N7TB

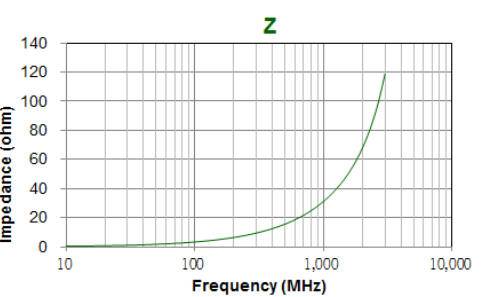
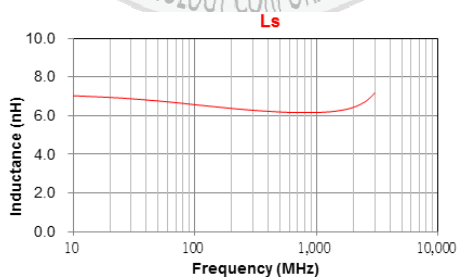
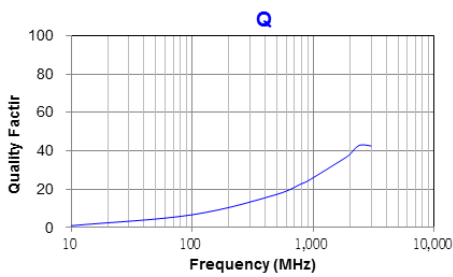

WLCM0603TN□5N1TB

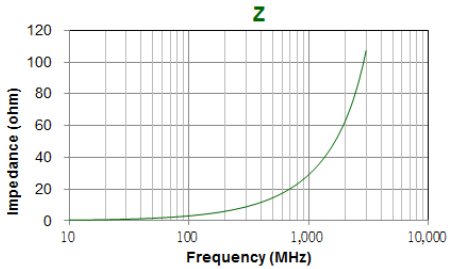
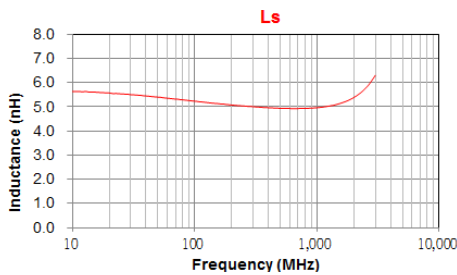
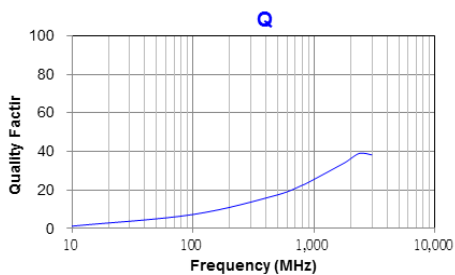

WLCM0603TN□5N6TB

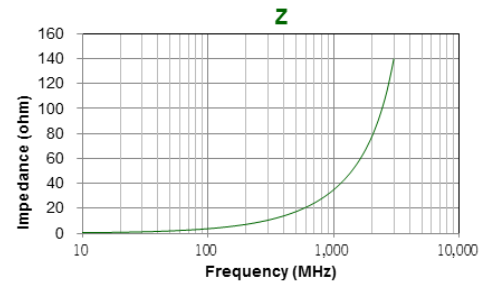
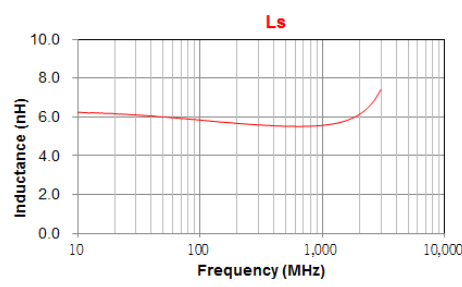
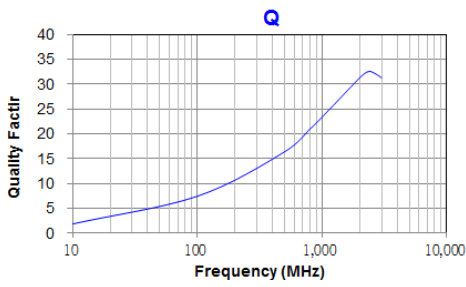

WLCM0603TN□6N2TB

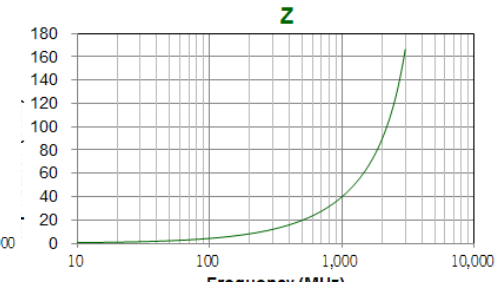
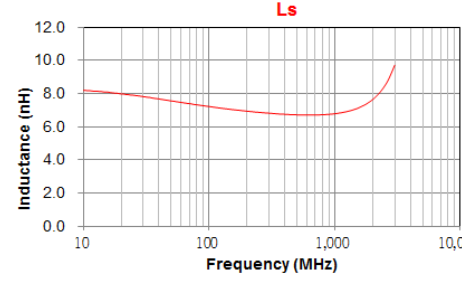
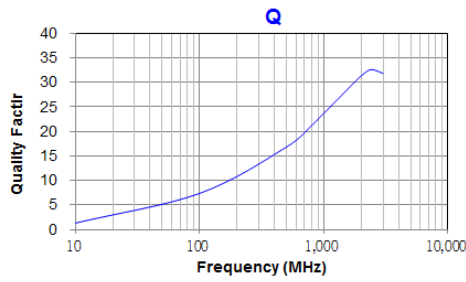

WLCM0603TN□6N8TB

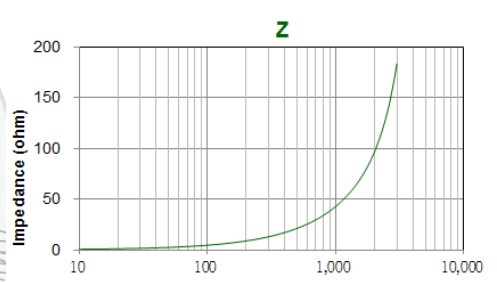
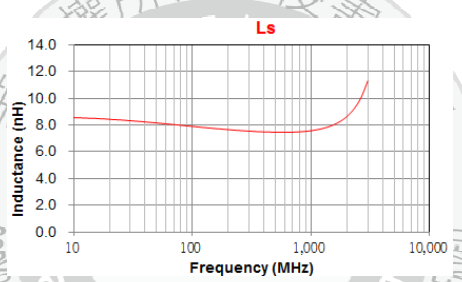
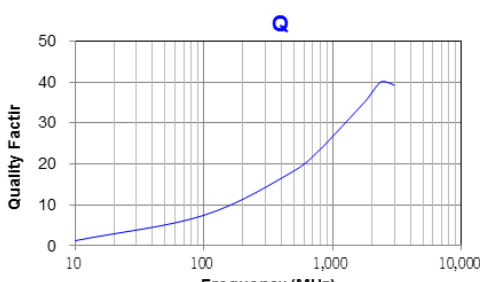

WLCM0603TN□7N5TB

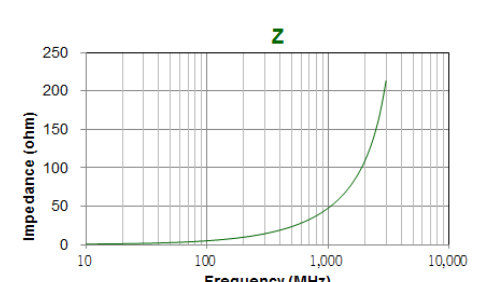
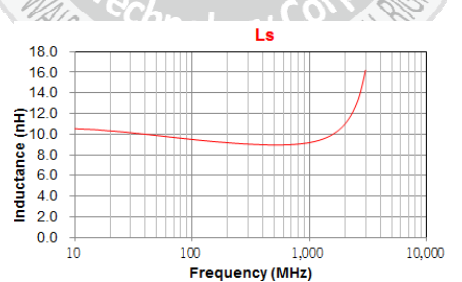
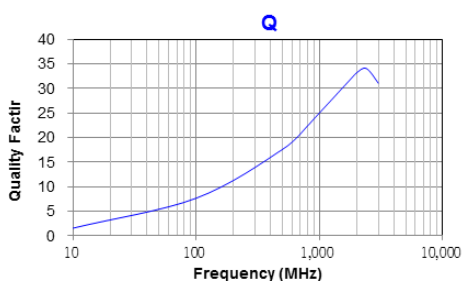

WLCM0603TN□8N2TB

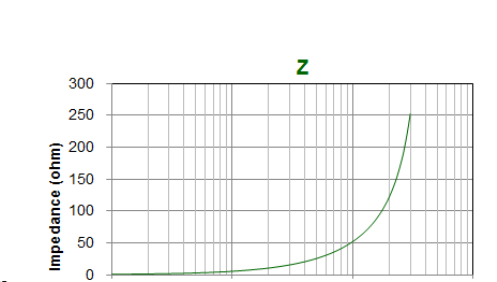
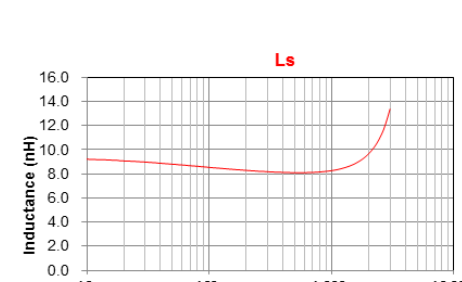
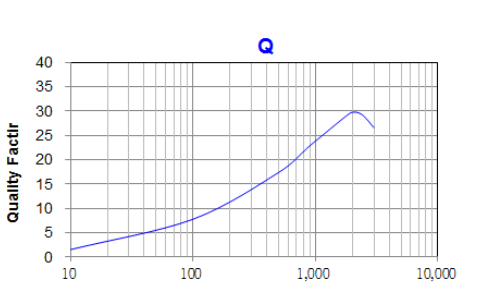

WLCM0603TN□9N1TB

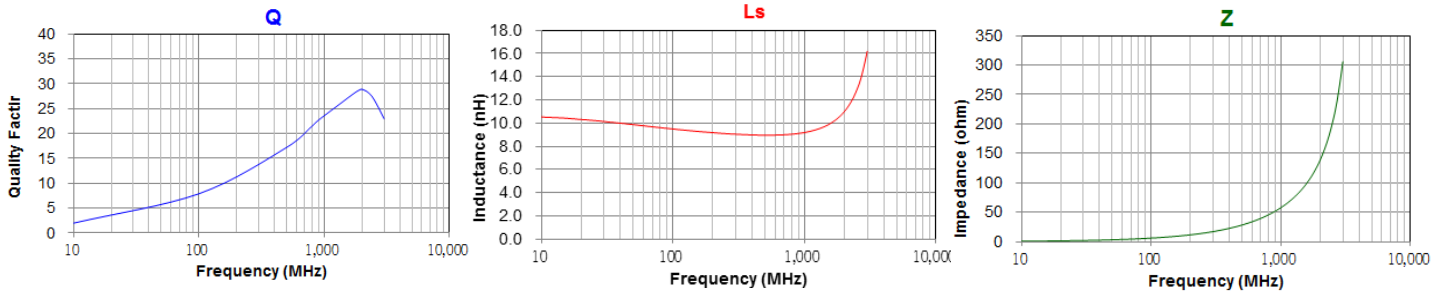

WLCM0603TN□10NTB

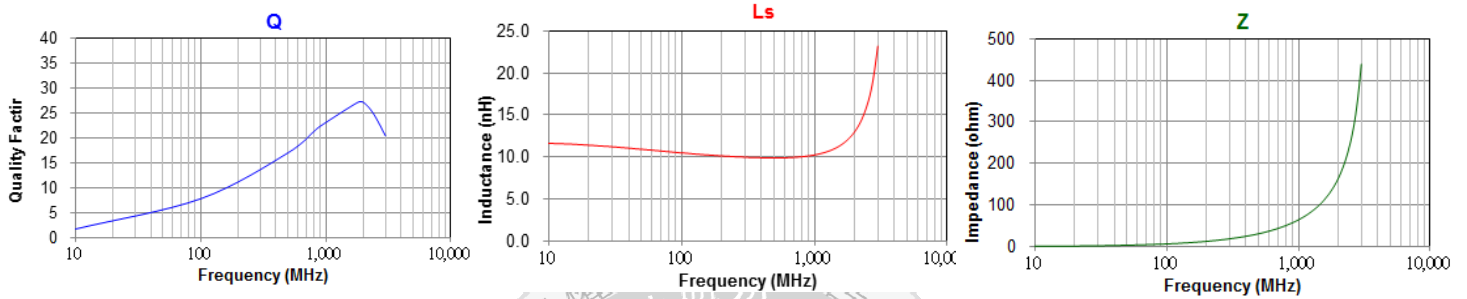

WLCM0603TN□11NTB

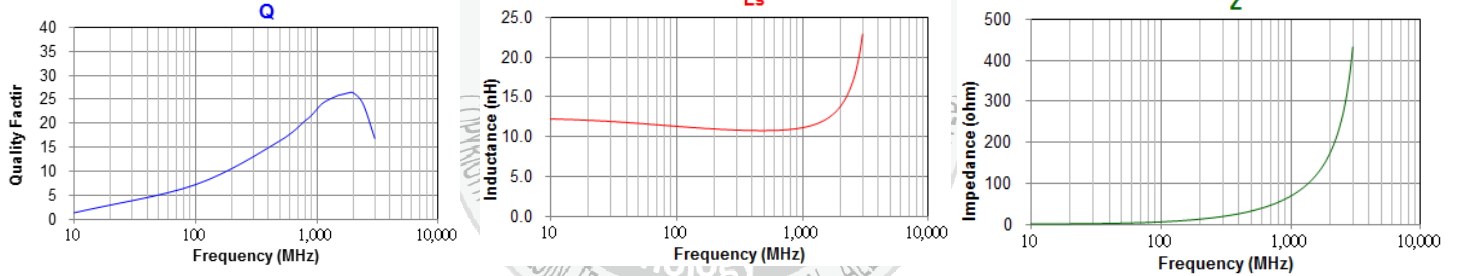

WLCM0603TN□12NTB

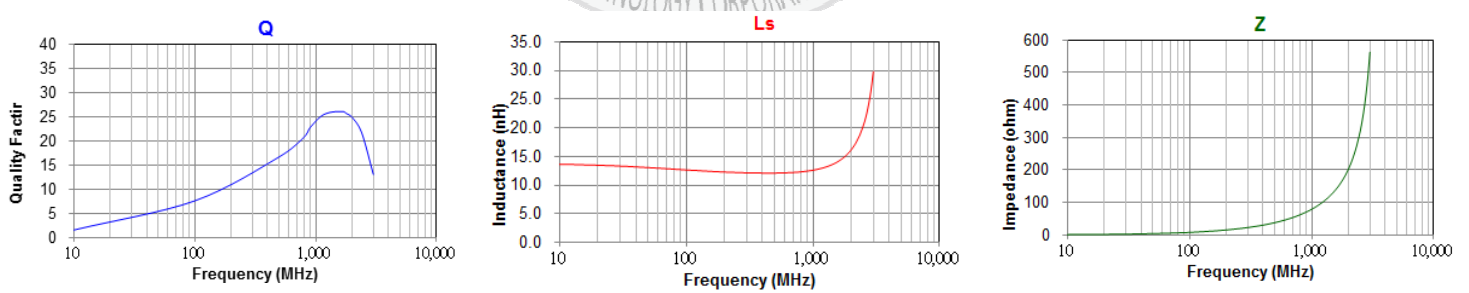

WLCM0603TN□13NTB

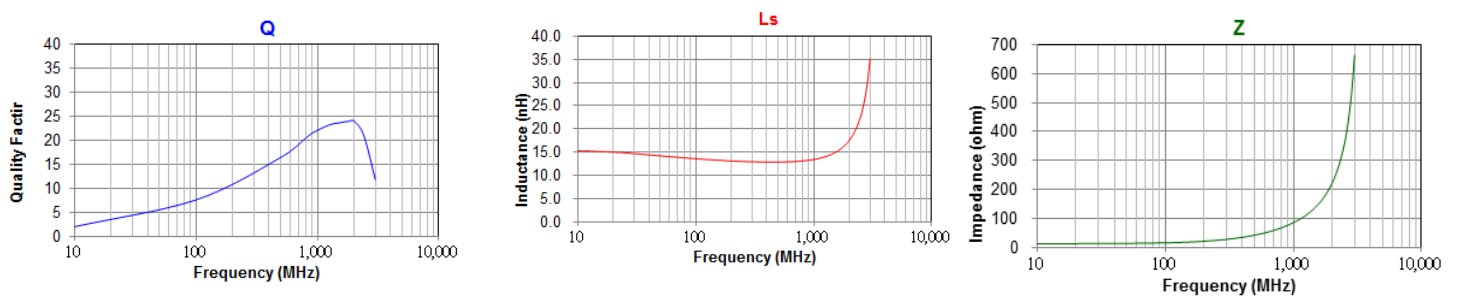

WLCM0603TN□15NTB

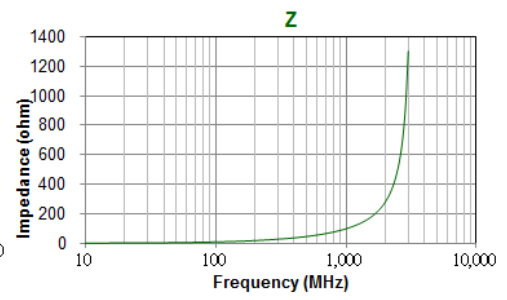
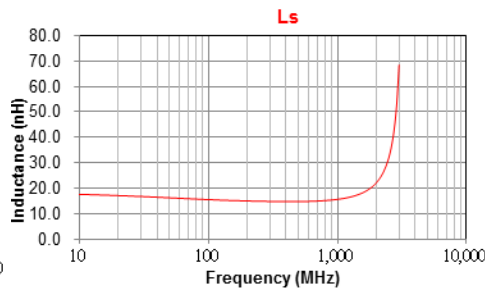
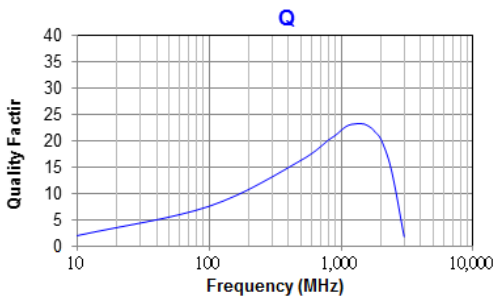

WLCM0603TN□16NTB

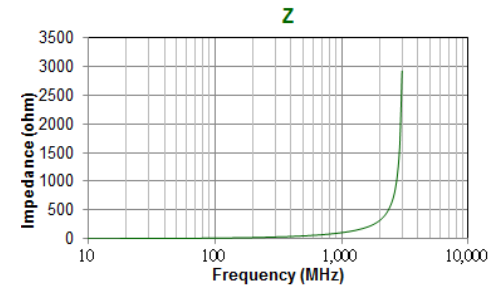
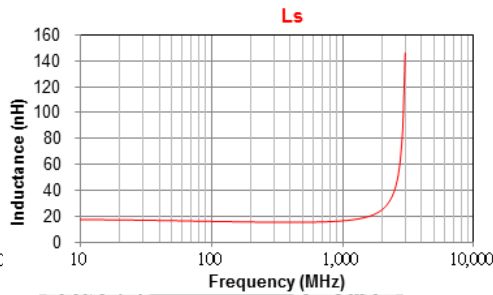
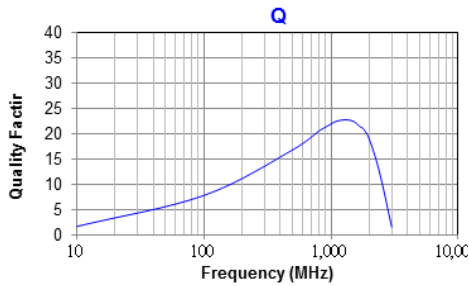

WLCM0603TN□18NTB

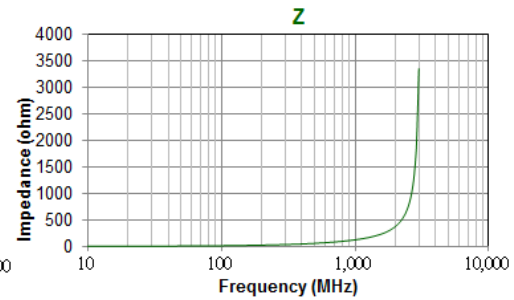
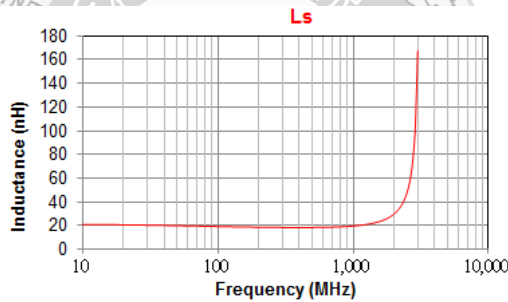
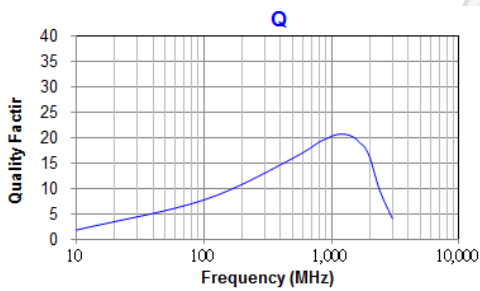

WLCM0603TN□20NTB

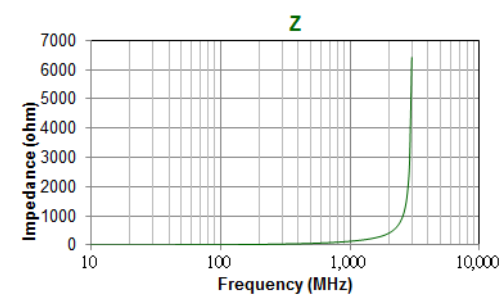
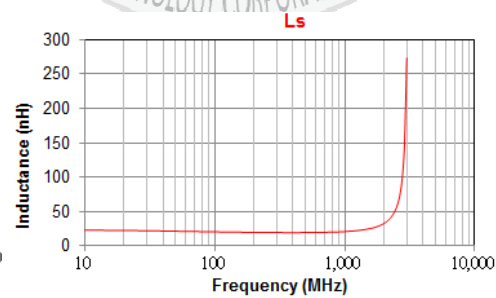
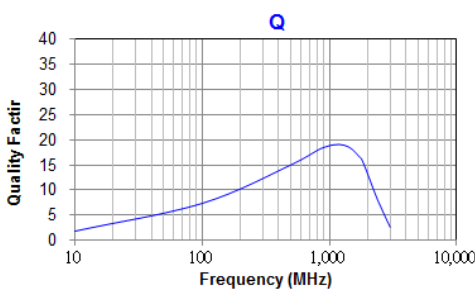

WLCM0603TN□22NTB

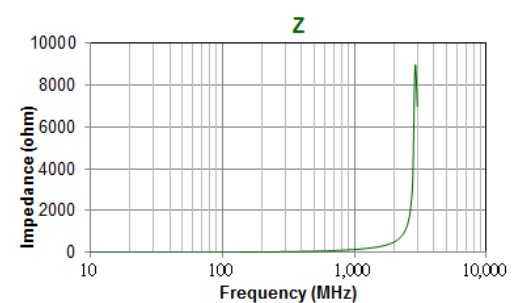
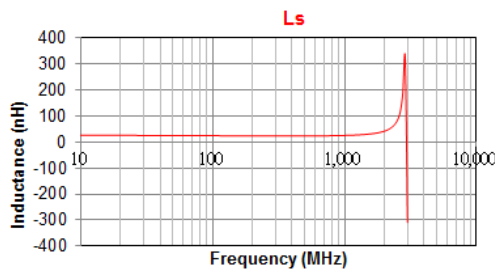
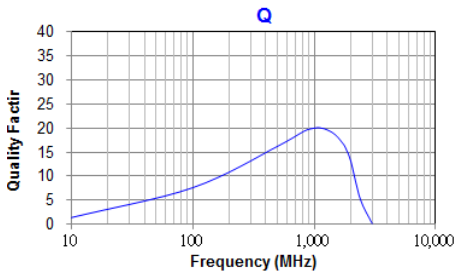

### Test condition & Requirements (WLCM0603TN series)

Item	Test condition	Requirements
<b>Temperature Cycle</b>	<ol style="list-style-type: none"> <li>1. Temperature : -55 ~ +125°C</li> <li>2. Cycle : 100 cycles</li> <li>3. Dwell time : 30minutes</li> <li>4. Measurement : at ambient temperature 24 hrs after test completion</li> </ol>	<ol style="list-style-type: none"> <li>1. No mechanical damage</li> <li>2. Inductance value should be within <math>\pm 10\%</math> of the initial value</li> <li>3. Q vale should be within <math>\pm 20\%</math> of the initial value</li> </ol>
<b>Operational Life</b>	<ol style="list-style-type: none"> <li>1. Temperature: 85 <math>\pm</math> 5°C</li> <li>2. Testing time: 1000 hrs</li> <li>3. Applied current: Full rated current</li> <li>4. Measurement: At ambient temperature 24 hours after test completion</li> </ol>	<ol style="list-style-type: none"> <li>1. No mechanical damage</li> <li>2. Inductance value should be within <math>\pm 10\%</math> of the initial value</li> <li>3. Q vale should be within <math>\pm 20\%</math> of the initial value</li> </ol>
<b>Biased Humidity</b>	<ol style="list-style-type: none"> <li>1. Temperature : 40°C <math>\pm</math> 2°C</li> <li>2. Humidity : 90 ~ 95 % RH</li> <li>3. Test time : 1000 hrs</li> <li>4. Apply current : full rated current</li> <li>5. Measurement : at ambient temperature 24 hrs after test completion</li> </ol>	<ol style="list-style-type: none"> <li>1. No mechanical damage</li> <li>2. Inductance value should be within <math>\pm 10\%</math> of the initial value</li> <li>3. Q vale should be within <math>\pm 20\%</math> of the initial value</li> </ol>
<b>Resistance to Solder Heat</b>	<ol style="list-style-type: none"> <li>1. Solder temperature : 260 <math>\pm</math> 5°C</li> <li>2. Flux : Rosin</li> <li>3. DIP time : 10 <math>\pm</math> 1 sec</li> </ol>	<ol style="list-style-type: none"> <li>1. More than 95 % of terminal electrode should be covered with new solder</li> <li>2. Inductance value should be within <math>\pm 10\%</math> of the initial value</li> <li>3. Q vale should be within <math>\pm 20\%</math> of the initial value</li> </ol>
<b>Solderability</b>	<ol style="list-style-type: none"> <li>1. Solder temperature : 235 <math>\pm</math> 5°C</li> <li>2. Flux : Rosin</li> <li>3. DIP time : 5 <math>\pm</math> 1 sec</li> </ol>	<ol style="list-style-type: none"> <li>1. More than 95 % of terminal electrode should be covered with new solder</li> <li>2. No mechanical damage</li> </ol>



<b>Bending Strength</b>	<p>1. Solder the chip to test jig then apply a force in the direction shown in below.</p> <p>2. The soldering shall be done with the reflow method and shall be conducted with care so that the soldering is uniform and free of defects such as heat shock.</p>	No mechanical damage
-------------------------	--	----------------------

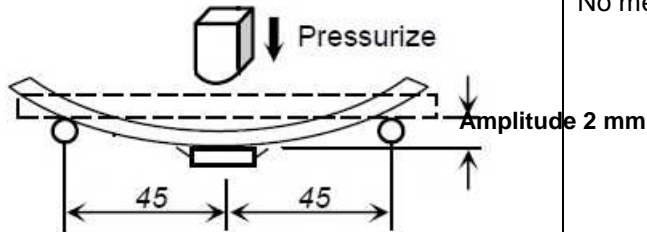

**NOTE**

The storage atmosphere must be free of gas containing sulfur and chlorine. Also, avoid exposing the product to saline moisture. If the product is exposed to such atmospheres, the terminals will oxidize and solderability will be affected.

**Packaging Specification**

**Leader and Trailer Tape**

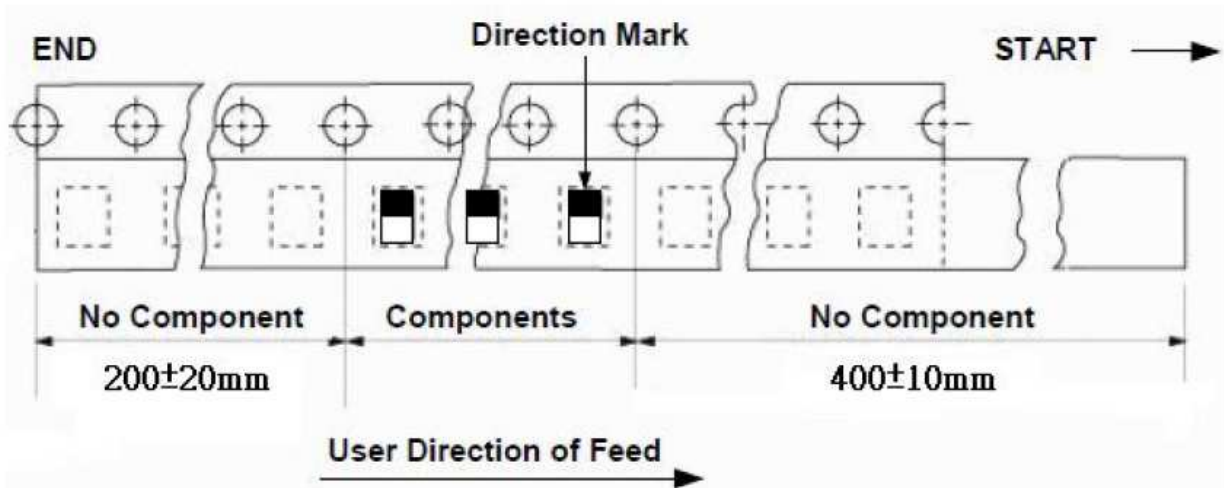

## Paper Tape

### Tape Dimension / 8mm

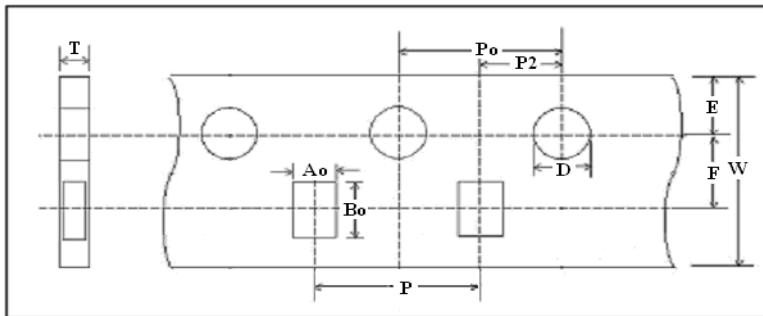

### Taping Dimension

(mm)	0603
Symbol	PAPER
W	8.00 ± 0.30
P	2.00 ± 0.10
E	1.75 ± 0.05
F	3.50 ± 0.05
D	1.50 ~ 1.60
Po	4.00 ± 0.10
P2	2.00 ± 0.05
Ao	0.38 ± 0.02
Bo	0.68 ± 0.02
T	0.42 ± 0.02

### REEL DIMENSION

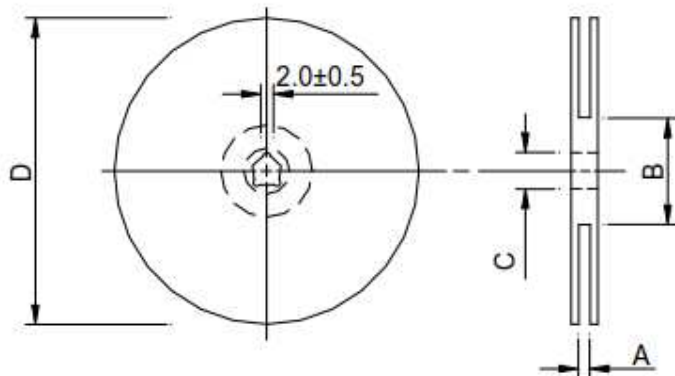

Type	A(mm)	B(mm)	C(mm)	D(mm)
7"	10±1.5	50 or more	13±0.5	178±2

7" Reel Packaging Quantity	
PART SIZE (EIA SIZE)	<b>0603 (0201)</b>
Qty.(pcs)	15,000

Unit : mm

### RECOMMENDED SOLDERING CONDITIONS

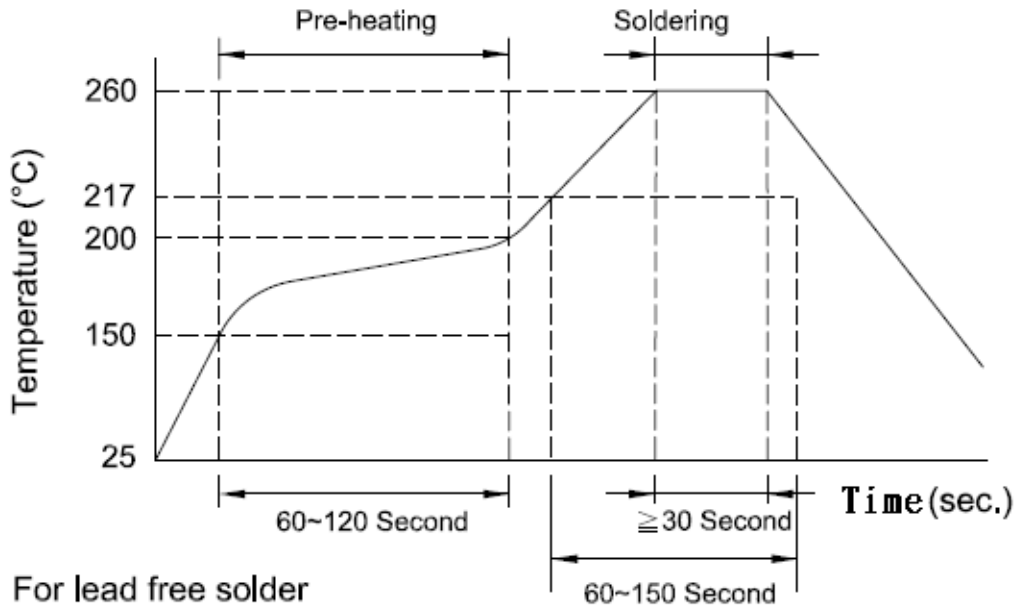

### LAND PATTERNS REFLOW SOLDERING

Solder land information :

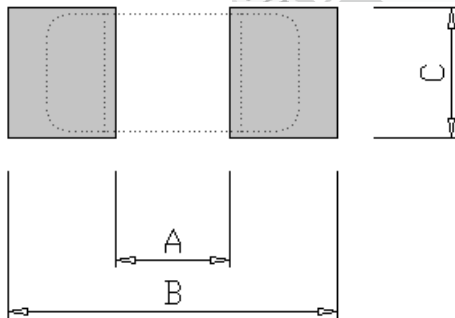

Size(mm)	A	B	C
0603 (EIA 0201)	0.20 ~ 0.30 (0.008 ~ 0.012)	0.80 ~ 0.90 (0.031 ~ 0.035)	0.20 ~ 0.30 (0.008 ~ 0.012)