

Sensor/actuator cable - SAC-3P-M12MS/0,3-PUR/BI-1L-Z - 1400772

Please be informed that the data shown in this PDF Document is generated from our Online Catalog. Please find the complete data in the user's documentation. Our General Terms of Use for Downloads are valid (<http://phoenixcontact.com/download>)



Sensor/actuator cable, 3-position, PUR halogen-free, black-gray RAL 7021, Plug straight M12, A-coded, on Valve connector BI (11 mm), with 1 LED, connected with Z diode, cable length: 0.3 m

As illustrated, but without SPEEDCON



Key Commercial Data

Packing unit	1 pc
GTIN	
GTIN	4046356511490

Technical data

Dimensions

Length of cable	0.3 m
-----------------	-------

Ambient conditions

Ambient temperature (operation)	-25 °C ... 90 °C (Plug / socket)
	-20 °C ... 85 °C (valve plug)
Degree of protection	IP65/IP67

General

Rated current at 40°C	4 A
Rated voltage	24 V AC
	24 V DC
Number of positions	3
Insulation resistance	≥ 100 MΩ
Coding	A - standard
Standards/regulations	M12 connector IEC 61076-2-101
	Valve connector EN 175301-803
Status display	1 LED

Sensor/actuator cable - SAC-3P-M12MS/0,3-PUR/BI-1L-Z - 1400772

Technical data

General

Protective circuit/component	Z diode
Overvoltage category	III
Degree of pollution	3
Insertion/withdrawal cycles	≥ 100

Material

Flammability rating according to UL 94	HB
Contact material	CuSn
Contact surface material	Ni/Au
Contact carrier material	TPU GF
Material of grip body	TPU
Valve plug contact material	CuSn
Valve plug contact surface material	Sn
Valve plug contact insert material	PA 6.6
Material housing valve plug	TPU
Material, knurls	Zinc die-cast, nickel-plated
Sealing material	TPU (Seal molded)

Standards and Regulations

Standard designation	M12 connector
Standards/regulations	IEC 61076-2-101
Standard designation	Valve connector
Standards/regulations	EN 175301-803
Flammability rating according to UL 94	HB

Cable

Cable type	PUR halogen-free black
Cable type (abbreviation)	PUR
Cable abbreviation	Li9Y11Y-HF
UL AWM style	20549
Conductor cross section	3x 0.5 mm ²
AWG signal line	20
Conductor structure signal line	28x 0.15 mm
Core diameter including insulation	1.5 mm ±0.05 mm (Signal line)
Wire colors	black 1, black 2, green/yellow
Overall twist	3 wires, twisted
External sheath, color	black-gray RAL 7021
External cable diameter D	4.5 mm ±0.2 mm
Smallest bending radius, fixed installation	22.5 mm
Number of bending cycles	15000000
Bending radius	50 mm
Traversing path	0.9 m

Sensor/actuator cable - SAC-3P-M12MS/0,3-PUR/BI-1L-Z - 1400772

Technical data

Cable

Traversing rate	5 m/s
Acceleration	30 m/s ²
Outer sheath, material	PUR
Material conductor insulation	PP
Conductor material	Bare Cu litz wires
Insulation resistance	min. 20 MΩ*km
Conductor resistance	39 Ω/km (at 20 °C)
Nominal voltage, cable	≤ 300 V
Test voltage, cable	≥ 1200 V
Flame resistance	according to DIN VDE 0482
	According to DIN EN 50265-2-1
Halogen-free	in accordance with DIN VDE 0472 part 815
Other resistance	largely oil-resistant
	partly UV-resistant in accordance with DIN EN ISO 4892-2-A
Ambient temperature (operation)	-40 °C ... 80 °C (cable, fixed installation)
	-20 °C ... 80 °C (cable, flexible installation)

Environmental Product Compliance

China RoHS	Environmentally Friendly Use Period = 50
	For details about hazardous substances go to tab "Downloads", Category "Manufacturer's declaration"

Drawings

Dimensional drawing

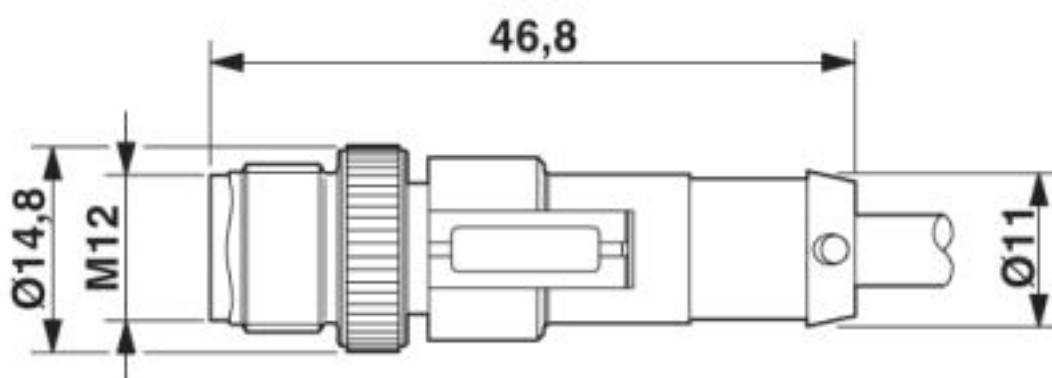

Plug, M12 x 1, straight, shielded

Sensor/actuator cable - SAC-3P-M12MS/0,3-PUR/BI-1L-Z - 1400772

Dimensional drawing

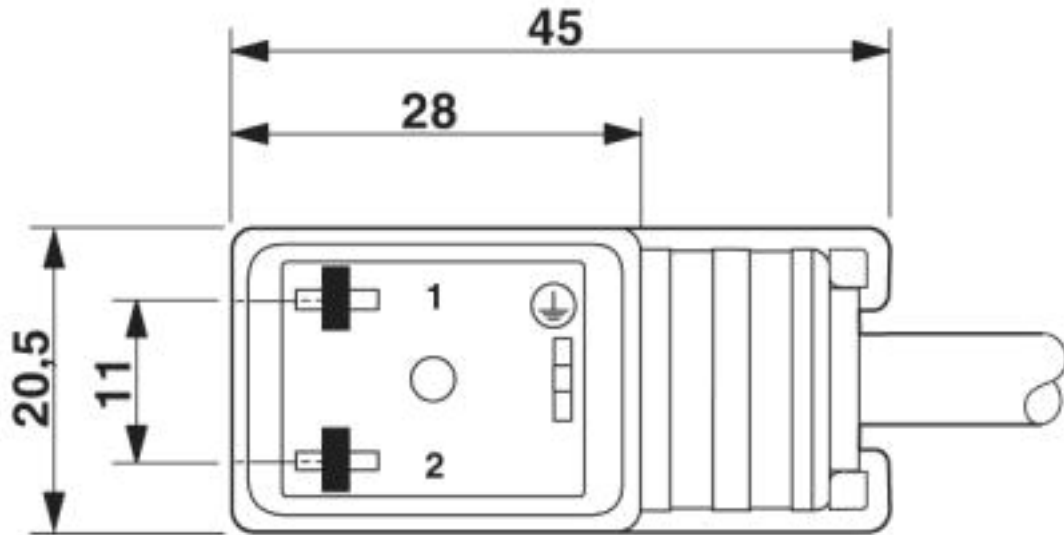

Valve connector, type BI

Dimensional drawing

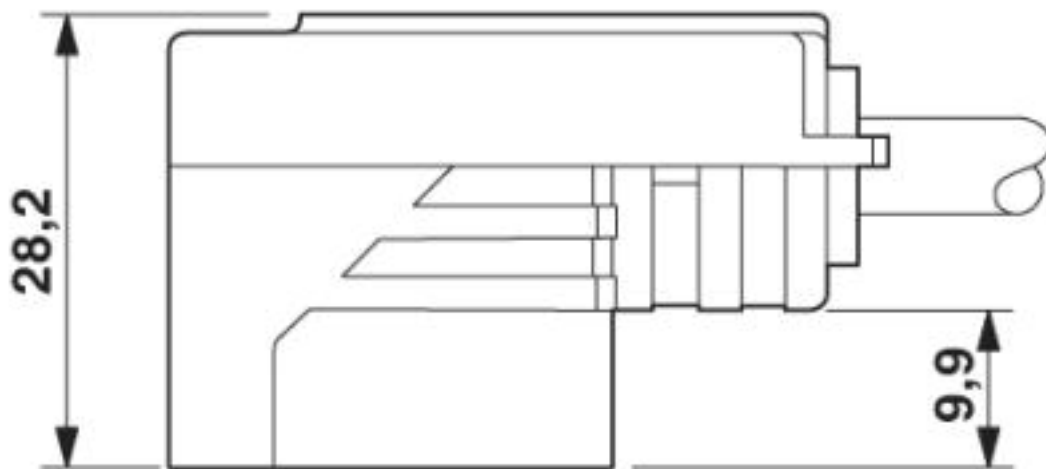

Valve connector, type BI, side view

Sensor/actuator cable - SAC-3P-M12MS/0,3-PUR/BI-1L-Z - 1400772

Circuit diagram

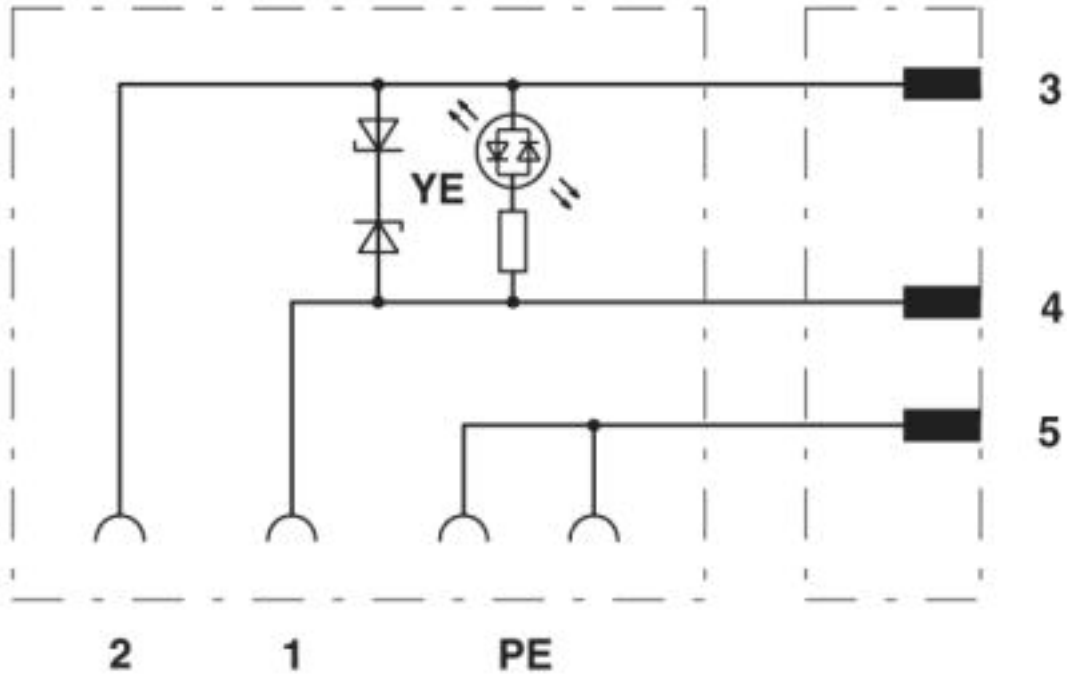

Contact assignment of M12 plug and valve connector

Sensor/actuator cable - SAC-3P-M12MS/0,3-PUR/BI-1L-Z - 1400772

Schematic diagram

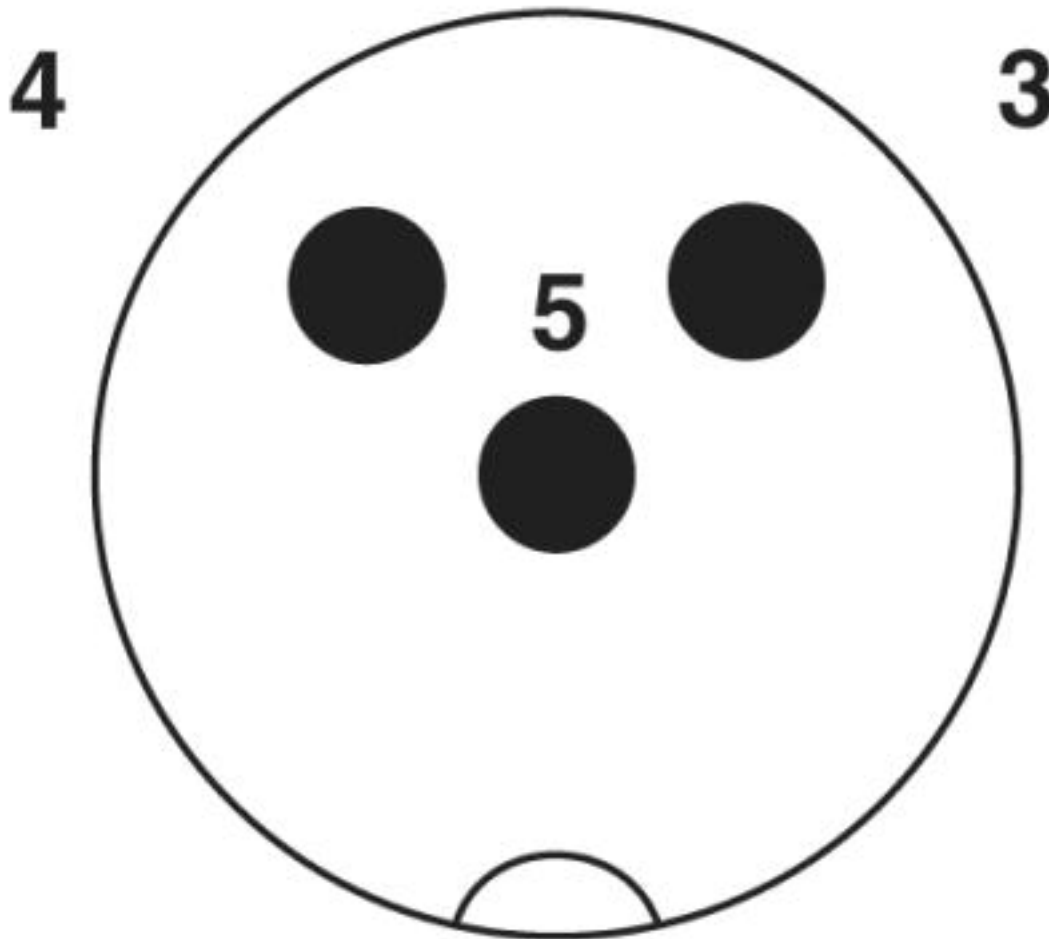

Pin assignment M12 plug, 3-pos., valve connector

Sensor/actuator cable - SAC-3P-M12MS/0,3-PUR/BI-1L-Z - 1400772

Cable cross section

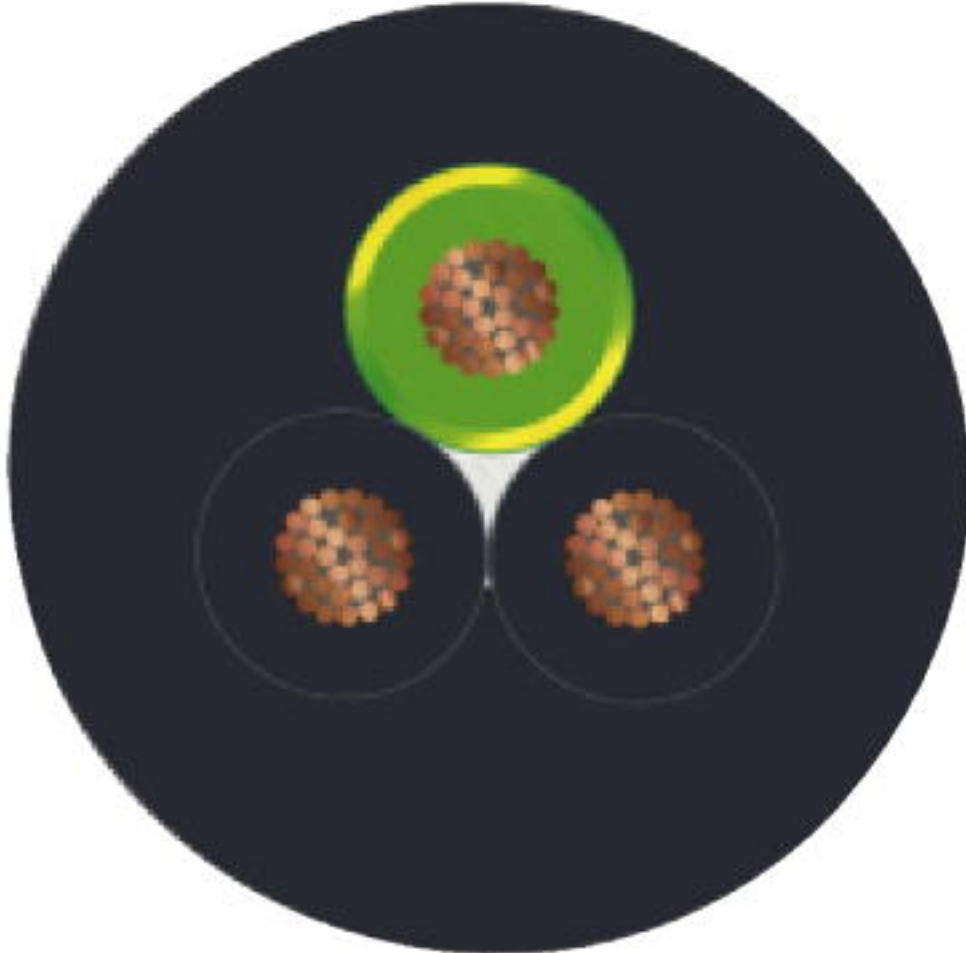

PUR halogen-free black [PUR]

Approvals

Approvals

Approvals

CSAus

Ex Approvals

Approval details

Sensor/actuator cable - SAC-3P-M12MS/0,3-PUR/BI-1L-Z - 1400772

Approvals

CSAus		http://www.csagroup.org/services-industries/product-listing/	13631
Nominal voltage UN		24 V	
Nominal current IN		4 A	

Phoenix Contact 2019 © - all rights reserved
<http://www.phoenixcontact.com>

PHOENIX CONTACT GmbH & Co. KG
Flachsmarktstr. 8
32825 Blomberg
Germany
Tel. +49 5235 300
Fax +49 5235 3 41200
<http://www.phoenixcontact.com>