

2-966067-0 ✓ ACTIVE

TE Internal #: 2-966067-0

Crimp Wire Pins, Tabs & Ferrules, Ferrule, 11 AWG Wire Size, 4 mm<sup>2</sup> Wire Size, 8234 CMA Wire Size, .19 in [4.8 mm] Barrel Inside Diameter, Closed

[View on TE.com >](#)



Terminals & Splices > Crimp Wire Pins, Tabs & Ferrules

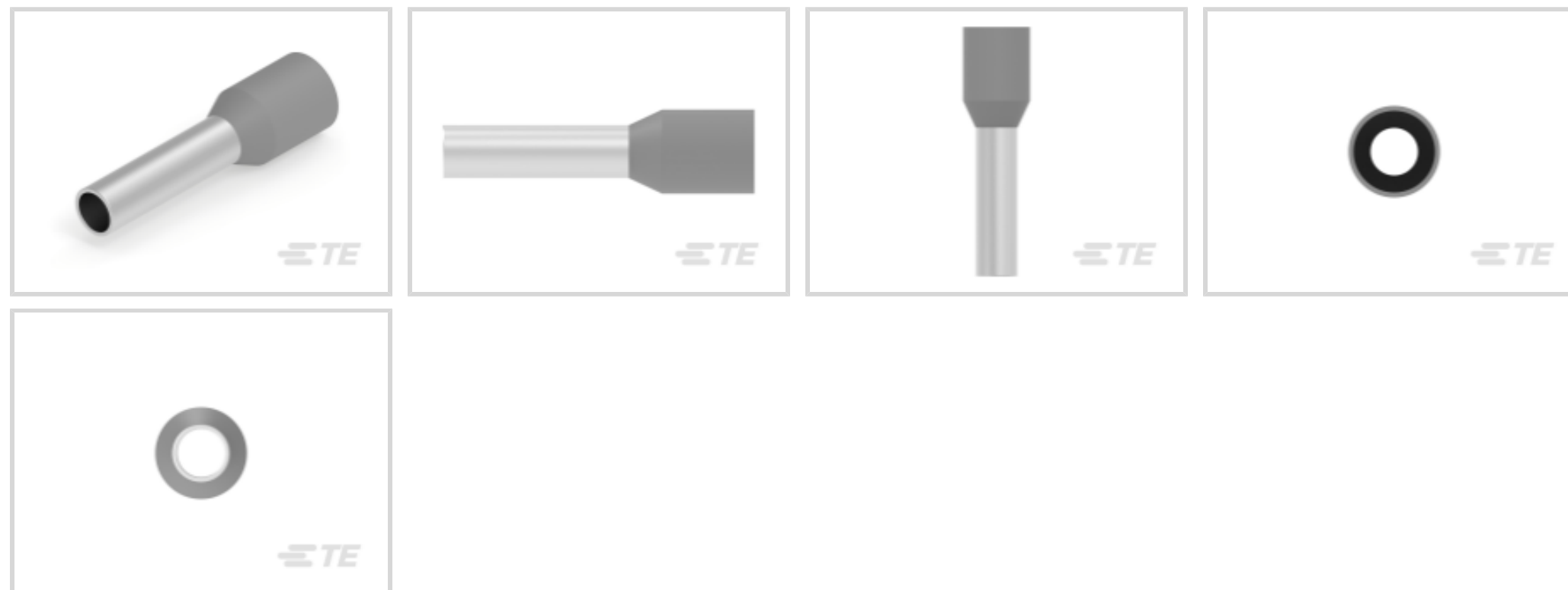

Crimp Wire Terminal Type: **Ferrule**

Compatible Insulation Diameter Range: 4.7 mm [ .185 in ]

Wire Size: **8234 CMA**

## Features

### Product Type Features

Sealable	No
Compatible With Discrete Wire Type	Stranded

### Configuration Features

Compatible With Wire & Cable Type	Discrete Wire
-----------------------------------	---------------

### Body Features

Primary Product Color	Gray
-----------------------	------

### Contact Features

Contact Mating Area Length	12 mm[.468 in]
Crimp Wire Terminal Type	Ferrule
Barrel Type	Closed
Terminal Plating Material	Tin
Terminal Orientation	Straight

### Mechanical Attachment

Wire Insulation Support	Without
-------------------------	---------

### Dimensions



2-Wire Size	11 AWG
Strip Length	14 mm[.551 in]
Compatible Insulation Diameter Range	4.7 mm[.185 in]
Wire Size	8234 CMA
Barrel Inside Diameter	4.8 mm[.19 in]
Terminal Material Thickness	.2 mm[.007 in]
Overall Product Length	20 mm[.787 in]

### Usage Conditions

Insulation Option	Partially Insulated
Operating Temperature Range	105 °C[221 °F]

### Packaging Features

Packaging Quantity	500
Packaging Method	Bag

### Product Compliance

[For compliance documentation, visit the product page on TE.com>](#)

EU RoHS Directive 2011/65/EU	Compliant
EU ELV Directive 2000/53/EC	Compliant
China RoHS 2 Directive MIIT Order No 32, 2016	No Restricted Materials Above Threshold
EU REACH Regulation (EC) No. 1907/2006	Current ECHA Candidate List: JAN 2023 (233) Candidate List Declared Against: JAN 2022 (223) Does not contain REACH SVHC
Halogen Content	Low Halogen - Br, Cl, F, I < 900 ppm per homogenous material. Also BFR/CFR/PVC Free
Solder Process Capability	Not applicable for solder process capability

#### Product Compliance Disclaimer

This information is provided based on reasonable inquiry of our suppliers and represents our current actual knowledge based on the information they provided. This information is subject to change. The part numbers that TE has identified as EU RoHS compliant have a maximum concentration of 0.1% by weight in homogenous materials for lead, hexavalent chromium, mercury, PBB, PBDE, DBP, BBP, DEHP, DIBP, and 0.01% for cadmium, or qualify for an exemption to these limits as defined in the Annexes of Directive 2011/65/EU (RoHS2). Finished electrical and electronic equipment products will be CE marked as required by Directive 2011/65/EU. Components may not be CE marked. Additionally, the part numbers that TE has identified as EU ELV compliant have a maximum concentration of 0.1% by weight in homogenous materials for lead, hexavalent chromium, and mercury, and 0.01% for cadmium, or qualify for an exemption to these limits as defined in the Annexes of Directive 2000/53/EC (ELV). Regarding the REACH Regulation, the information TE provides

on SVHC in articles for this part number is based on the latest European Chemicals Agency (ECHA) 'Guidance on requirements for substances in articles' posted at this URL: <https://echa.europa.eu/guidance-documents/guidance-on-reach>

## Compatible Parts



TE Part # 539660-1  
ADERENDHUELSEN (Ferrule) Crimp Tool



TE Part # 7-1579014-0  
HT FOR CABLE-END SLEEVES 0,08-10



TE Part # 1SET191003R0000  
FER-SE-HT

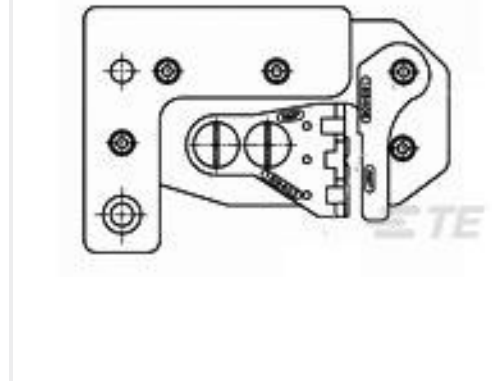

TE Part # 2-1579001-3  
CSE10-AE22 CRIMP HEAD

## Customers Also Bought



TE Part #640457-5  
05P MTA100 HDR ASSY SQ R/A F/L



TE Part #1445049-4  
FREE HANG SNGL ROW HSG 4 POS

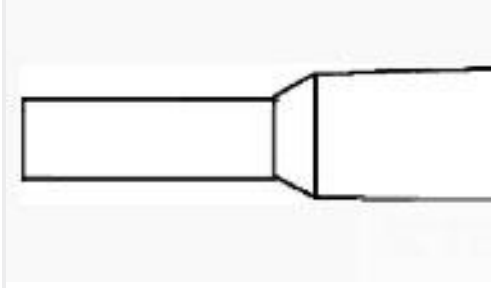

TE Part #1-966067-6  
FER,WIRE,PL SLV,2.50/14,L8,BLUE,LP

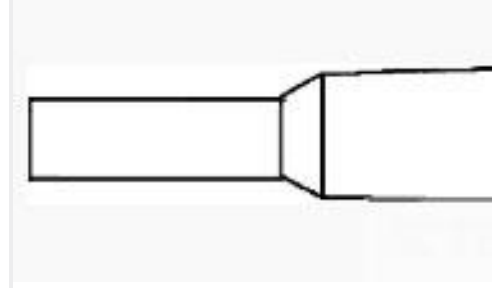

TE Part #1-966067-2  
FER,WIRE,PL SLV,1.50/16,L8,BLACK,LP

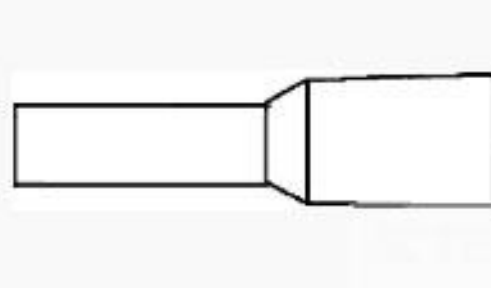

TE Part #2-966067-4  
FER,WIRE,PL SLV,10.00/8,L12,RED,LP

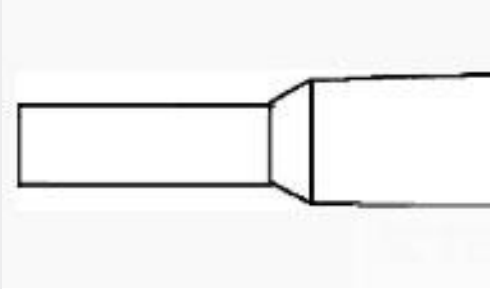

TE Part #966067-9  
FER,WIRE,PL SLV,1.00/18,L8,RED,LP



TE Part #1-1470107-0  
2.0MM PITCH CRIMP HOUSING 10P



TE Part #1-2176250-0  
TJT 500W 33R 5%

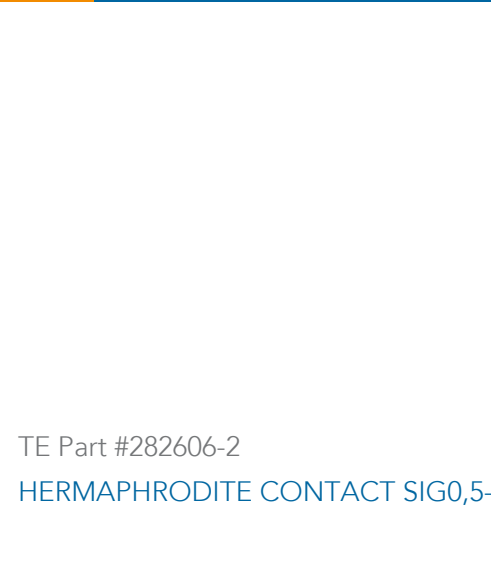

TE Part #282606-2  
HERMAPHRODITE CONTACT SIG0,5-1

## Documents

### Product Drawings

FER,WIRE,PL SLV,4.00/12,L12,GREY,LP

English



### CAD Files

#### Customer View Model

[ENG\\_CVM\\_CVM\\_2-966067-0\\_B.3d\\_igs.zip](#)

English

#### 3D PDF

English

#### Customer View Model

[ENG\\_CVM\\_2-966067-0\\_B1.2d\\_dxf.zip](#)

English

#### Customer View Model

[ENG\\_CVM\\_2-966067-0\\_B1.3d\\_igs.zip](#)

English

#### Customer View Model

[ENG\\_CVM\\_2-966067-0\\_B1.3d\\_stp.zip](#)

English

By downloading the CAD file I accept and agree to the [Terms and Conditions](#) of use.

---

### Datasheets & Catalog Pages

#### Wire Ferrules

English

#### WIRE END FERRULES

English

---

### Agency Approvals

#### CSA Certificate

English