



A Product Line of
Diodes Incorporated



SPECIFICATION FOR APPROVAL

CUSTOMER	_____
NOMINAL FREQUENCY	30.000000 MHz
PRODUCT TYPE	TYPE FJ 2.5x2.0 SEAM SEALED CRYSTAL CLOCK OSCILLATOR
SPEC. NO. (P/N)	FJ3000005Q
CUSTOMER P/N	_____
ISSUE DATE	June 12, 2018
VERSION	B

APPROVED	PREPARED	QA
<i>Brenda Kuo</i>	<i>Winnie Chang</i>	<i>Dony Yang</i>

Diodes Incorporated

No.2, Ziqiang 5th Rd., Zhongli Industrial Park,
 Zhongli Dist., Taoyuan City 32063, Taiwan (R.O.C.)
 TEL: 886-3-451-8888
 FAX: 886-3-461-3865
<https://www.diodes.com>

- *Pb-free
- *RoHS Compliant
- *HF-Halogen Free
- *REACH Compliant
- *AEC-Q200 Compliant

TYPE FJ 2.5x2.0 SEAM SEALED CRYSTAL CLOCK OSCILLATOR

FJ3000005Q

VER. B 12-Jun-18

ELECTRICAL SPECIFICATIONS

SRe Part Number : FJ3000005Q

Item	Symbol	Specifications	Units	Notes
Nominal Frequency	F _o	30.000000	MHz	
Frequency Stability	FT	± 25	ppm	**See note
Operating Temperature Range	TR	-40 to +85	°C	
Supply Voltage	V _{DD}	+1.8 ± 5%	V	
Logic Type	LT	LVC MOS		
Supply Current, Output Enabled	I _{DD} /OE	6	mA	Max
Supply Current, Output Disabled	I _{DD} /OD	10	µA	Max
Duty Cycle (Symmetry)	DC/SY	45 / 55	%	Measured 50% of Waveform
Rise / Fall Time	T _R /T _F	6	ns	Max. measured 10 / 90% of Waveform
Output Voltage "0" Level	V _{OL}	10% V _{DD}	V	Max
Output Voltage "1" Level	V _{OH}	90% V _{DD}	V	Min
Output Load	CL	15	pF	Max
Jitter, Phase	RMS	1.5	ps	Max. 12KHz ~ 5MHz Frequency Band
Jitter, Accumulated	RMS(1-σ)	5	ps	Typ. 20,000 Consecutive Periods
Jitter, Peak to Peak	Pk-Pk	50	ps	Max. 100,000 Random Periods
Start Up Time		10	ms	Max.
Storage Temperature Range		-55 to +125	°C	

※ This product doesn't include harmful substance that stipulated by SONY SS-00259 Level 1 and S-AT2-001 Level 1 standard. RoHS Compliant (Pb - Free).

**Stability includes all combinations of Operating Temperature, Load changes, rated Input (Supply) Voltage changes, Initial Calibration Tolerance (25°C), Aging (1 year at 25°C Average Effective Ambient Temperature), Shock and Vibration.

Output Enable / Disable Function

Parameter	Min.	Typ.	Max.	Units	Notes
Input Voltage (Pin1), Output Enable	0.7V _{DD}			V	Or Open
Input Voltage (Pin1), Output Disable (low power standby)			0.3V _{DD}	V	Output is Hi-Z
Internal Pullup Resistance	30			KΩ	
Output Disable Delay			50	ns	

TYPE FJ 2.5x2.0 SEAM SEALED CRYSTAL CLOCK OSCILLATOR

FJ3000005Q

VER. B 12-Jun-18

TEST CIRCUIT

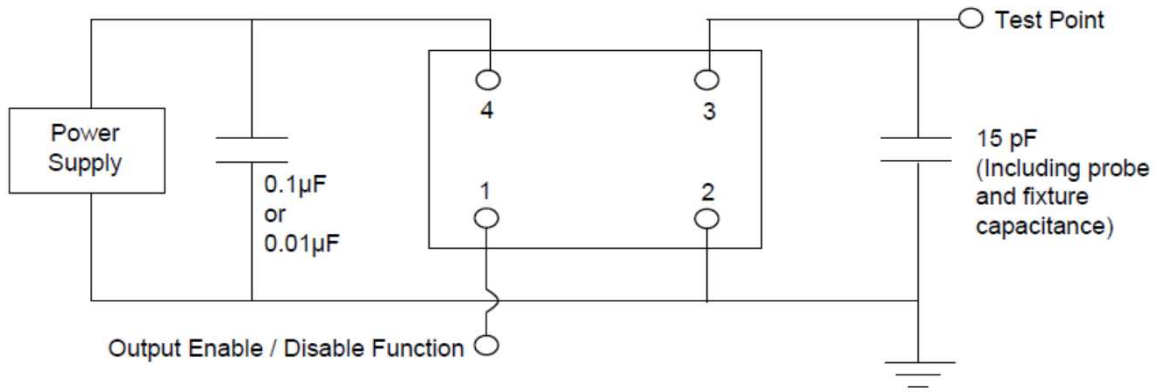

OUTPUT WAVEFORM

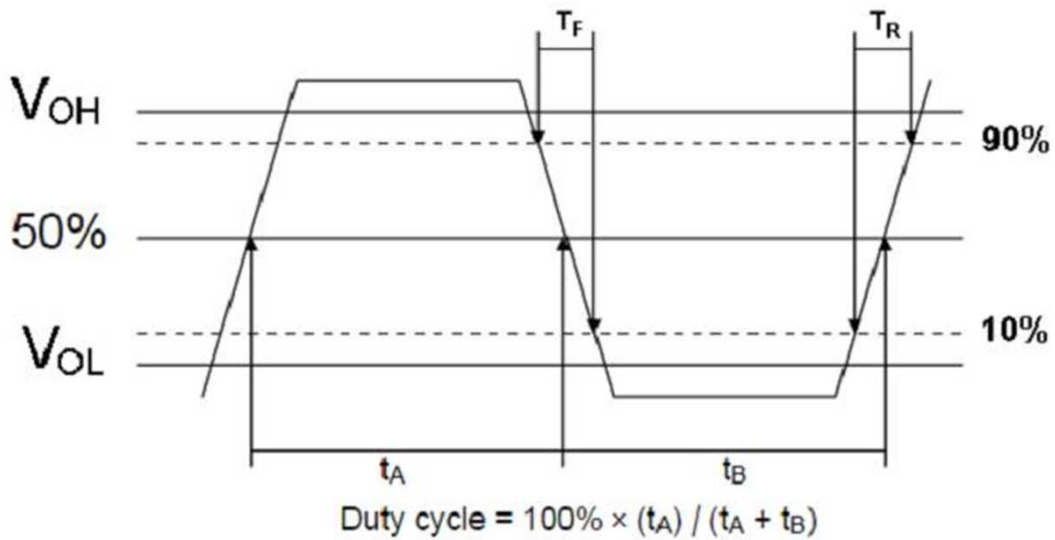

TYPE FJ 2.5x2.0 SEAM SEALED CRYSTAL CLOCK OSCILLATOR

FJ3000005Q

VER. B 12-Jun-18

AEC-Q200 RELIABILITY TEST SPECIFICATIONS:

1. Initial

- 1.1 Physical Dimensions: JESD22, Method JB1-100
- 1.2 External Visual: MIL-STD-883, Method 2009
- 1.3 Freq. Vs. Temperature: Per Specification/Datasheet

2. Mechanical

- 2.1 Mechanical Shock: MIL-STD-202 Method 213
- 2.2 Vibration: MIL-STD-202 Method 204
- 2.3 Solderability: J-STD-002
- 2.4 Board Flex: AEC Q200-005
- 2.5 Terminal Strength (SMD): AEC Q200-006

3.Environmental

- 3.1 Temp Cycle: JESD22, Method JA-104
- 3.2 Resistance to Solder Heat: MIL-STD-202 Method 210
- 3.3 High Temperature Operating Life: MIL-STD-202, Method 108
- 3.4 High Temp Exposure: MIL-STD-202, Method 108
- 3.5 High Temp & High Humidity: MIL-STD-202, Method 103
- 3.6 Thermal Shock: MIL-STD-202, Method 107

SUGGESTED IR REFLOW PROFILE

*As per IPC-JEDEC J-STD-020D

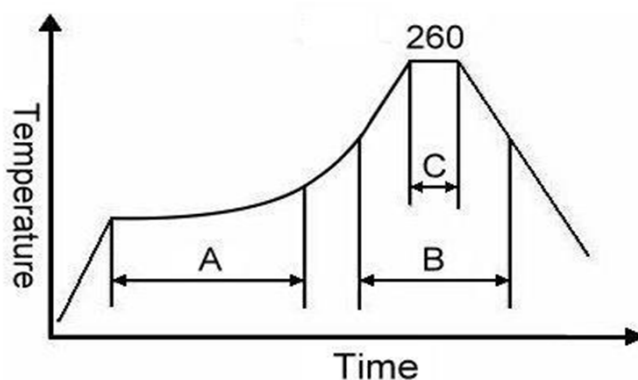

Note:

	Stage	Temperature	Time
A	Preheat	150~200°C	60~120 Sec
B	Primary Heat	217°C	60~150 Sec
C	Peak	260°C	10 Sec

TYPE FJ 2.5x2.0 SEAM SEALED CRYSTAL CLOCK OSCILLATOR

FJ3000005Q

VER. B 12-Jun-18

MARKING

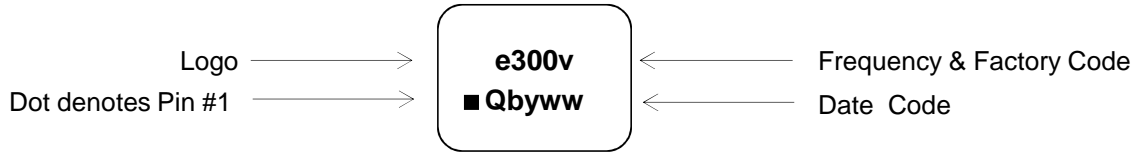

Qb
Model Series

y
Year Code (last digit of year)

ww
Week Code

v
Factory Code

MECHANICAL DRAWINGS (Scale:None. Dimensions are in mm.)

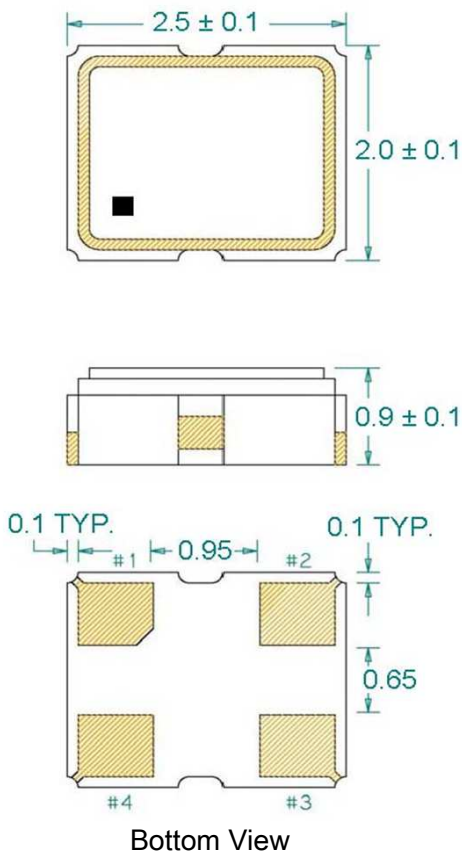

Recommended Land Pattern*

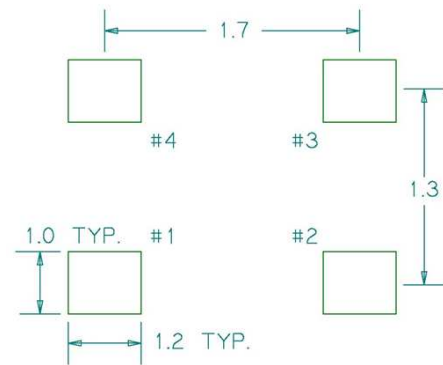

*External high-frequency power decoupling is recommended.(see test circuit for minimum recommendation). To ensure optimal performance, do not route traces beneath the package.

Pin	Function
1	OE
2	Ground
3	Clock Output
4	V _{DD}

TYPE FJ 2.5x2.0 SEAM SEALED CRYSTAL CLOCK OSCILLATOR

FJ300005Q

VER. B 12-Jun-18

TAPE & REEL

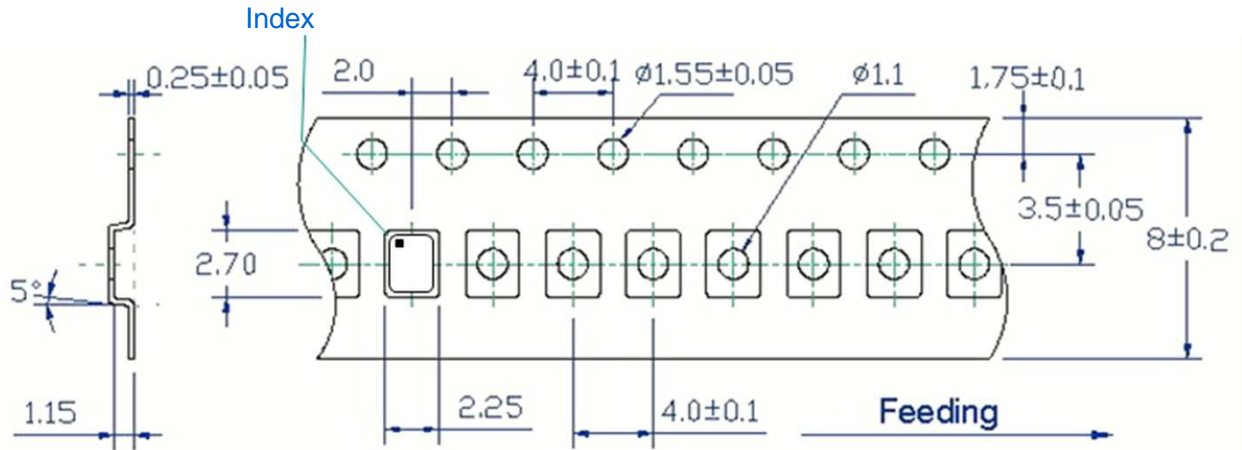

1. 230mm minimum leader which consist of carrier and/or tape followed by a minimum of 160mm of empty carrier tape sealed with cover tape.
2. 160mm minimum trailer of empty carrier tape sealed with cover tape.

TYPE FJ 2.5x2.0 SEAM SEALED CRYSTAL CLOCK OSCILLATOR

FJ3000005Q

VER. B 12-Jun-18

PACKING

