

# High Voltage MOSFET

N-Channel, Depletion Mode

**IXTH 20N50D**  
**IXTT 20N50D**

$$V_{DSS} = 500 \text{ V}$$

$$I_{D25} = 20 \text{ A}$$

$$R_{DS(on)} = 0.33 \Omega$$

## Preliminary Data Sheet

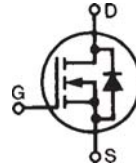

Symbol	Test Conditions	Maximum Ratings	
$V_{DSX}$	$T_J = 25^\circ\text{C}$ to $150^\circ\text{C}$	500	V
$V_{DGX}$	$T_J = 25^\circ\text{C}$ to $150^\circ\text{C}$	500	V
$V_{GS}$	Continuous	$\pm 30$	V
$V_{GSM}$	Transient	$\pm 40$	V
$I_{D25}$	$T_C = 25^\circ\text{C}$	20	A
$I_{DM}$	$T_C = 25^\circ\text{C}$ ; pulse width limited by $T_{JM}$	50	A
$P_D$	$T_C = 25^\circ\text{C}$	400	W
$T_J$		-55 ... +150	$^\circ\text{C}$
$T_{JM}$		150	$^\circ\text{C}$
$T_{stg}$		-55 ... +150	$^\circ\text{C}$
$T_L$	1.6 mm (0.063 in) from case for 10 seconds	300	$^\circ\text{C}$
$T_{ISOL}$	Plastic case for 10 seconds	300	$^\circ\text{C}$
$M_d$	Mounting torque	1.13/10	Nm/lb.in.
Weight	TO-247	6	g
	TO-268	4	g

TO-247 (IXFH)

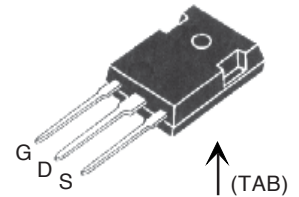

TO-268 (IXTT)

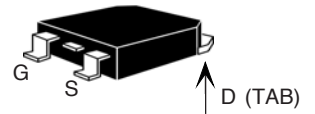

G = Gate                      D = Drain  
S = Source                    TAB = Drain

## Features

- Normally ON Mode
- International standard packages
- Molding epoxies meet UL94 V-0 flammability classification

## Applications

- Level shifting
- Triggers
- Solid State Relays
- Current Regulators
- Active load

Symbol	Test Conditions	Characteristic Values ( $T_J = 25^\circ\text{C}$ , unless otherwise specified)		
		min.	typ.	max.
$V_{DSX}$	$V_{GS} = -10 \text{ V}$ , $I_D = 250 \text{ mA}$	500		V
$V_{GS(off)}$	$V_{DS} = 25 \text{ V}$ , $I_D = 250 \text{ mA}$	-1.5		V
$I_{GSS}$	$V_{GS} = \pm 30 \text{ V}_{DC}$ , $V_{DS} = 0$			$\pm 100 \text{ nA}$
$I_{DSX(off)}$	$V_{DS} = V_{DSS}$ $V_{GS} = -10 \text{ V}$	$T_J = 25^\circ\text{C}$ $T_J = 125^\circ\text{C}$		25 $\mu\text{A}$
				500 $\mu\text{A}$
$R_{DS(on)}$	$V_{GS} = 10 \text{ V}$ , $I_D = 10 \text{ A}$ Note 1			0.33 $\Omega$
$I_{D(on)}$	$V_{GS} = 0 \text{ V}$ , $V_{DS} = 25 \text{ V}$ Note 1		1.5	A

Symbol	Test Conditions	Characteristic Values		
		$(T_J = 25^\circ\text{C}, \text{ unless otherwise specified})$		
		min.	typ.	max.
$g_{fs}$	$V_{DS} = 30\text{ V}, I_D = 10\text{ A}, \text{ Note 1}$	4.0	7.5	S
$C_{iss}$	$V_{GS} = -10\text{ V}, V_{DS} = 25\text{ V}, f = 1\text{ MHz}$		2500	pF
$C_{oss}$		400	pF	
$C_{rss}$		100	pF	
$t_{d(on)}$	$V_{GS} = 0\text{ V to } -10\text{ V}, V_{DS} = 0.5 \cdot V_{DSX}$ $I_D = 10\text{ A}, R_G = 4.7\ \Omega \text{ (External)},$		35	ns
$t_r$		85	ns	
$t_{d(off)}$		110	ns	
$t_f$		75	ns	
$Q_{g(on)}$	$V_{GS} = 10\text{ V}, V_{DS} = 0.5 \cdot V_{DSX}, I_D = 0.5 \cdot I_{D25}$		125	nC
$Q_{gs}$		35	nC	
$Q_{gd}$		51	nC	
$R_{thJC}$			0.31	K/W
$R_{thCK}$		0.25	K/W	

Symbol	Test Conditions	Characteristic Values		
		$(T_J = 25^\circ\text{C}, \text{ unless otherwise specified})$		
		min.	typ.	max.
$V_{SD}$	$I_F = I_{D25}, V_{GS} = -10\text{ V}, \text{ Note 1}$	0.85	1.5	V
$t_{rr}$	$I_F = 20\text{ A}, -di/dt = 100\text{ A}/\mu\text{s}, V_R = 100\text{ V}$ $V_{GS} = -10\text{ V}$		510	ns

Note 1: Pulse test,  $t \leq 300\ \mu\text{s}$ , duty cycle  $d \leq 2\%$

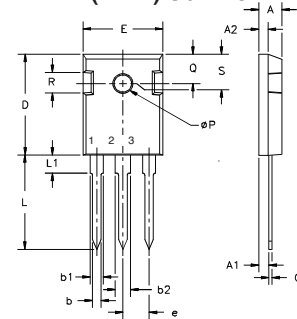
**TO-247 AD (IXTH) Outline**

Terminals:  
 1 - Gate    2 - Drain  
 3 - Source Tab - Drain

Dim.	Millimeter		Inches	
	Min.	Max.	Min.	Max.
A	4.7	5.3	.185	.209
A <sub>1</sub>	2.2	2.54	.087	.102
A <sub>2</sub>	2.2	2.6	.059	.098
b	1.0	1.4	.040	.055
b <sub>1</sub>	1.65	2.13	.065	.084
b <sub>2</sub>	2.87	3.12	.113	.123
C	.4	.8	.016	.031
D	20.80	21.46	.819	.845
E	15.75	16.26	.610	.640
e	5.20	5.72	0.205	0.225
L	19.81	20.32	.780	.800
L <sub>1</sub>		4.50		.177
∅P	3.55	3.65	.140	.144
Q	5.89	6.40	0.232	0.252
R	4.32	5.49	.170	.216
S	6.15	BSC	.242	BSC

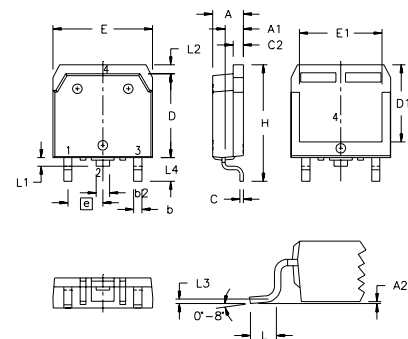
**TO-268 (IXTTH) Outline**

Terminals:  
 1 - Gate    2 - Drain  
 3 - Source Tab - Drain

SYM	INCHES		MILLIMETERS	
	MIN	MAX	MIN	MAX
A	.193	.201	4.90	5.10
A <sub>1</sub>	.106	.114	2.70	2.90
A <sub>2</sub>	.001	.010	0.02	0.25
b	.045	.057	1.15	1.45
b <sub>2</sub>	.075	.083	1.90	2.10
C	.016	.026	0.40	0.65
C <sub>2</sub>	.057	.063	1.45	1.60
D	.543	.551	13.80	14.00
D <sub>1</sub>	.488	.500	12.40	12.70
E	.624	.632	15.85	16.05
E <sub>1</sub>	.524	.535	13.30	13.60
e	.215	BSC	5.45	BSC
H	.736	.752	18.70	19.10
L	.094	.106	2.40	2.70
L <sub>1</sub>	.047	.055	1.20	1.40
L <sub>2</sub>	.039	.045	1.00	1.15
L <sub>3</sub>	.010	BSC	0.25	BSC
L <sub>4</sub>	.150	.161	3.80	4.10

IXYS reserves the right to change limits, test conditions, and dimensions.

IXYS MOSFETs and IGBTs are covered by one or more of the following U.S. patents:	4,835,592	4,931,844	5,049,961	5,237,481	6,162,665	6,404,065 B1	6,683,344	6,727,585
	4,850,072	5,017,508	5,063,307	5,381,025	6,259,123 B1	6,534,343	6,710,405 B2	
	4,881,106	5,034,796	5,187,117	5,486,715	6,306,728 B1	6,583,505	6,710,463	

**Fig. 1. Output Characteristics  
@ 25°C**

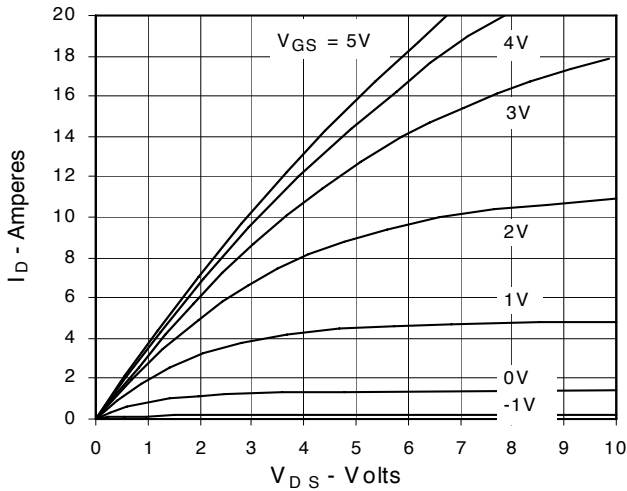

**Fig. 2. Extended Output Characteristics  
@ 25°C**

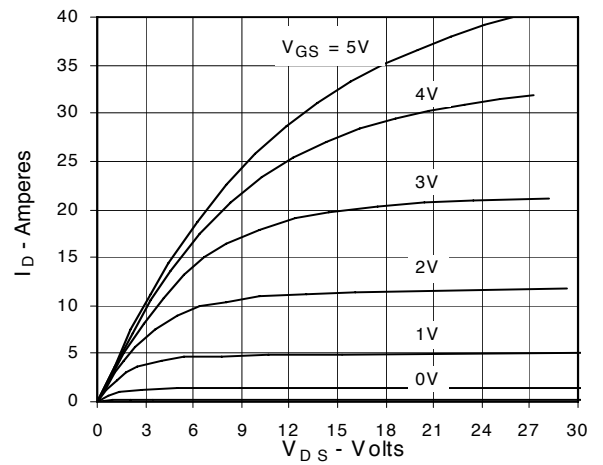

**Fig. 3. Output Characteristics  
@ 125°C**

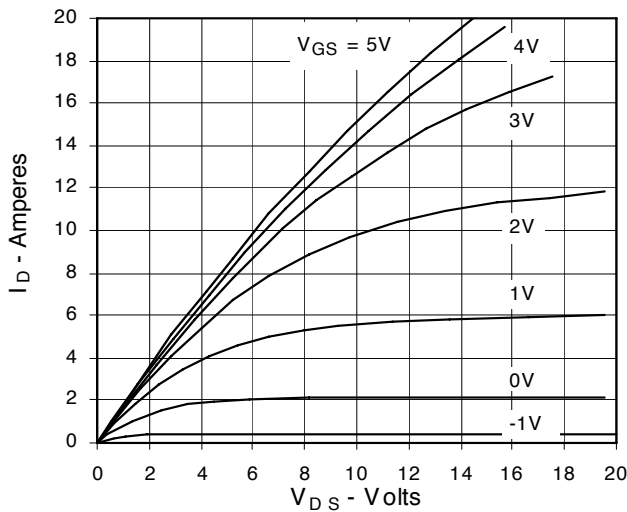

**Fig. 4.  $R_{DS(on)}$  Normalized to 0.5  $I_{D25}$   
Value vs. Junction Temperature**

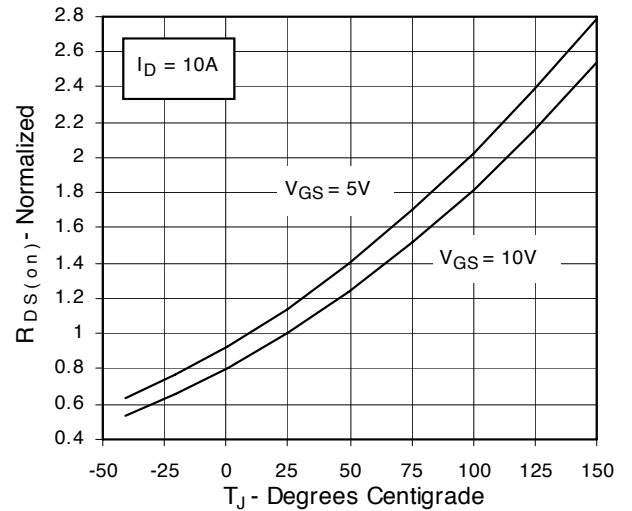

**Fig. 5.  $R_{DS(on)}$  Normalized to  
0.5  $I_{D25}$  Value vs.  $I_D$**

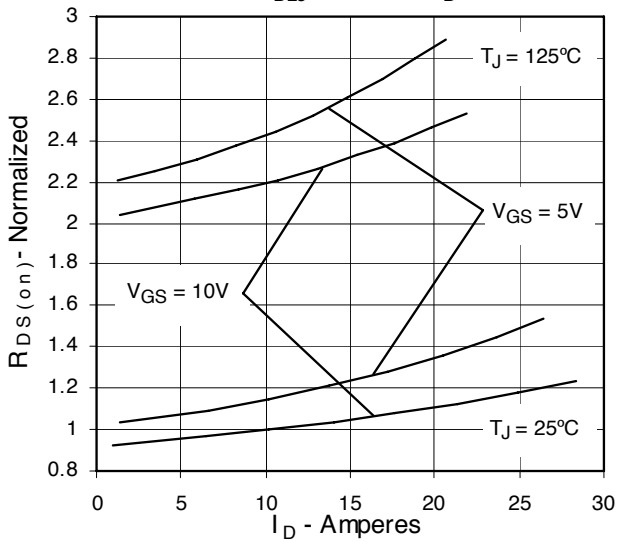

**Fig. 6. Drain Current vs. Case  
Temperature**

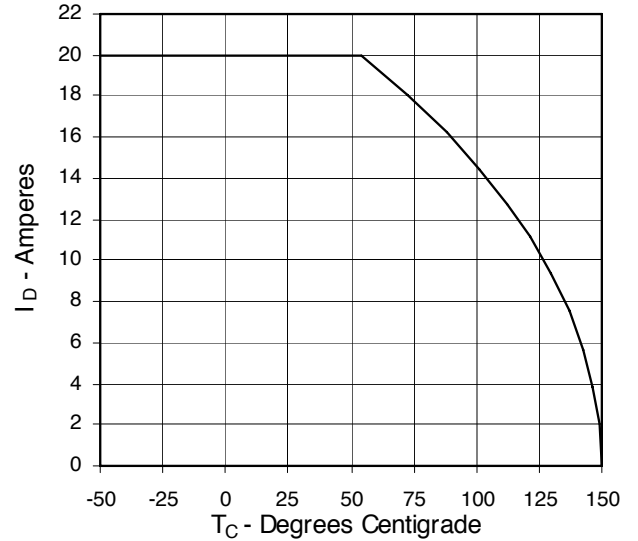

**Fig. 7. Input Admittance**

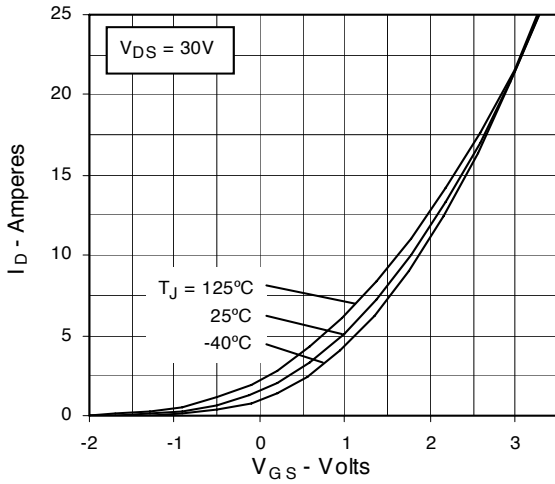

**Fig. 8. Transconductance**

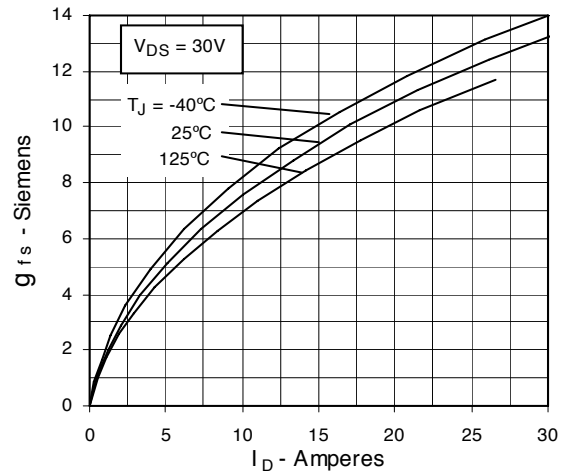

**Fig. 9. Source Current vs. Source-To-Drain Voltage**

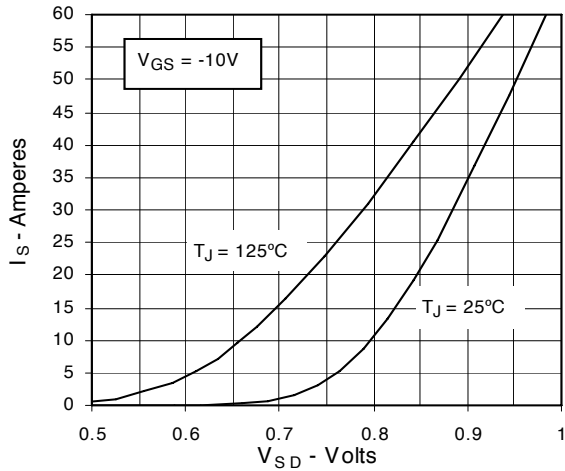

**Fig. 10. Dependence of Breakdown and Threshold Voltages on Temperature**

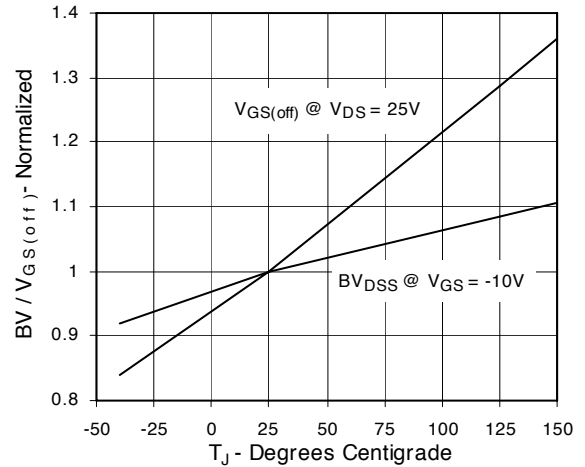

**Fig. 11. Gate Charge**

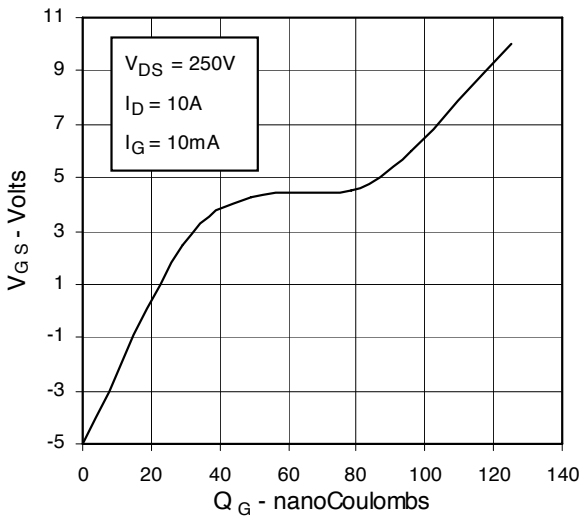

**Fig. 12. Capacitance**

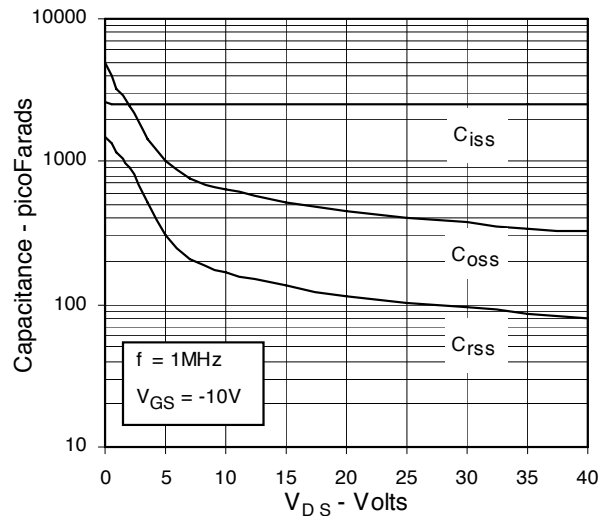

**Fig. 13. Forward-Bias  
Safe Operating Area**

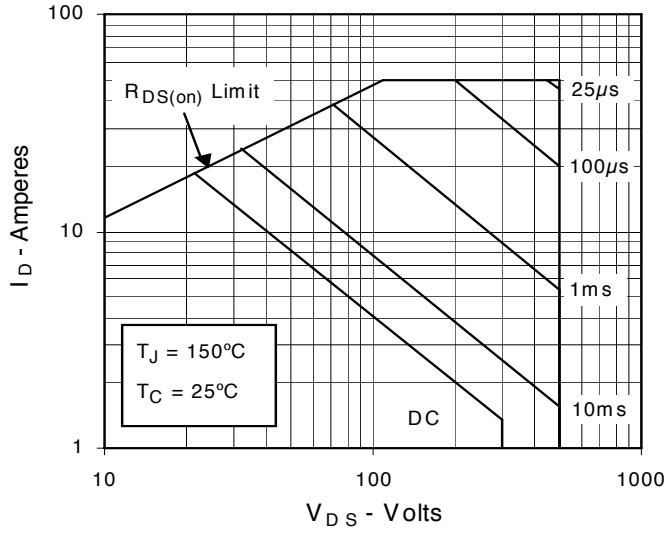

**Fig. 14. Maximum Transient Thermal Resistance**

