

TVNow™ (NN01-047) – Mobile TV Dual- band DVB-H (UHF + L band) Antenna

TVNow[™] (NN01-047) – Mobile TV Dual-band DVB-H (UHF + L band) Antenna

Ignion specializes in enabling effective mobile communications. Using Ignion technology, we design and manufacture optimized antennas to make your wireless devices more competitive. Our mission is to help our clients develop innovative products and accelerate their time to market through our expertise in antenna design, testing and manufacturing.

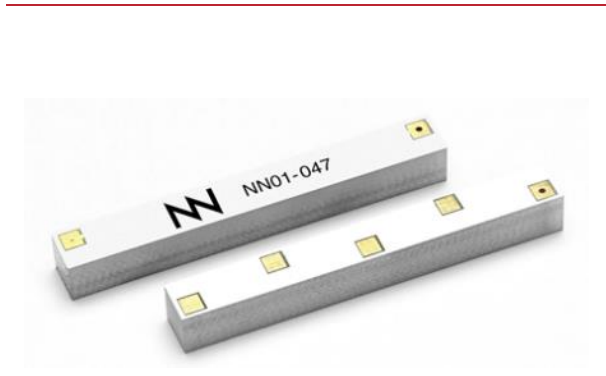

TVNow[™]

NN01-047

Ignion products are protected by [Ignion patents](#).

All information contained within this document is property of Ignion and is subject to change without prior notice. Information is provided “as is” and without warranties. It is prohibited to copy or reproduce this information without prior approval.

Ignion is an ISO 9001:2015 certified company. All our [antennas](#) are lead-free and RoHS compliant.

ISO 9001: 2015 Certified



INDEX OF CHAPTERS

1. ANTENNA DESCRIPTION	5
2. QUICK REFERENCE GUIDE	5
3. ELECTRICAL PERFORMANCE	6
4. MECHANICAL CHARACTERISTICS	10
5. ASSEMBLY PROCESS	12
6. PRODUCT CHANGE NOTIFICATION	14

TABLE OF CONTENTS

1. ANTENNA DESCRIPTION	5
2. QUICK REFERENCE GUIDE	5
3. ELECTRICAL PERFORMANCE	6
3.1. EVALUATION BOARD	6
3.2. MATCHING NETWORK	7
3.3. RADIATION PATTERNS AND GAIN	8
3.4. CAPABILITIES AND MEASUREMENT SYSTEMS	9
4. MECHANICAL CHARACTERISTICS	10
4.1. DIMENSIONS AND TOLERANCES	10
4.2. SPECIFICATIONS FOR THE INK	10
4.3. ANTENNA FOOTPRINT	11
5. ASSEMBLY PROCESS	12
6. PRODUCT CHANGE NOTIFICATION	14

1. ANTENNA DESCRIPTION

The TVNow[™] is an off-the-shelf internal antenna solution specifically designed for DVB-H applications, covering UHF and L-band requirements.

TVNow[™] minimizes your product development cost and time. It combines small size and high performance making TVNow[™] an optimal choice for your portable DVB-H applications.



Material: The TVNow[™] antenna is built on glass epoxy substrate.

APPLICATIONS

- Mobile phones
- Personal Media Player (PMP)
- Ultra Mobile PC (UMPC)
- Secure Digital (SD) cards

BENEFITS

- Reduced Form Factor
- Modularity – SMD
- Superior Performance
- High Isolation (DVB-H and GSM)

2. QUICK REFERENCE GUIDE

Technical Features	
Frequency Range with GSM Coexistence	470 – 698 MHz 1670 – 1675 MHz
Gain Curve	>2dBi margin with DVB-H recommendations
Radiation Pattern	Omnidirectional
Gain Flatness (horizontal diagram)	±2 dB
Weight (approx.)	1.9 g
Temperature	-40 to +125 °C
Impedance	50 Ω
Dimensions (L x W x H)	40.0 mm x 5.0 mm x 4.8 mm

Table 1 – Technical Features. Measures from the evaluation board. See Figure 1.

Please contact support@ignion.io if you require additional information on antenna integration or optimization on your PCB.

3. ELECTRICAL PERFORMANCE

3.1. EVALUATION BOARD

The configuration used in testing the TVNow[™] Dual band (UHF+Lband) DVB-H antenna is displayed in Figure 1.

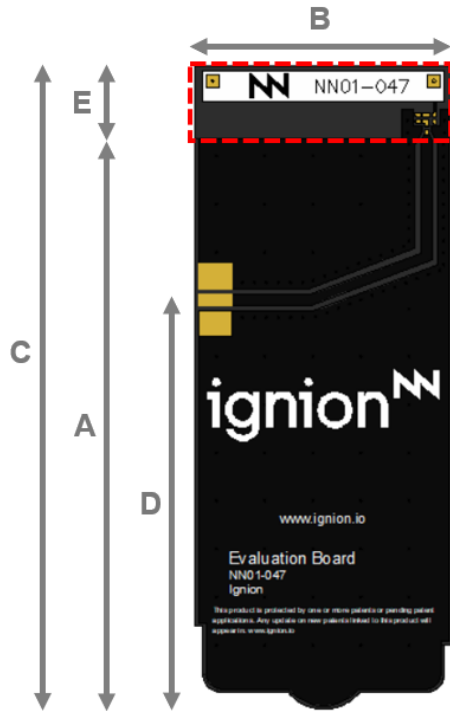

Measure	mm
A	95.0
B	42.7
C	107.0
D	68.0
E	12.0

Tolerance: ±0.2mm

Material: The evaluation board is built on laminated substrate 1.0 mm thick (2 layers).

Clearance Area: 12.0 mm x 42.7 mm (ExB)

Figure 1 – EB_NN01-047. TVNow[™] Dual Band (UHF+Lband) DVB-H.

3.2. MATCHING NETWORK

The specs of a Ignion standard antenna are measured in their evaluation board, which is an ideal case. In a real design, components nearby the antenna, LCD's, batteries, covers, connectors, etc. affect the antenna performance. This is the reason why it is highly recommended placing pads compatible with 0402 and 0603 SMD components for a PI matching network as close as possible to the antenna feeding point. Do it in the ground plane area, not in the clearance area. This is a degree of freedom to tune the antenna once the design is finished and considering all elements of the series (batteries, displays, covers, etc.).

Please notice that different devices with different ground planes and different components nearby the TVNow[™] Dual Band (UHF+Lband) DVB-H antenna may need a different matching network. To ensure optimal results, the use of high Q and tight tolerance components is highly recommended (Murata components). If you need assistance to design your matching network beyond this application note, please contact support@ignion.io, or try our free-of-charge¹ **NN Wireless Fast-Track** design service, you will get your chip antenna design including a custom matching network for your device in 24h¹. Other related to NN's range of R&D services is available at: <https://www.ignion.io/rdservices/>

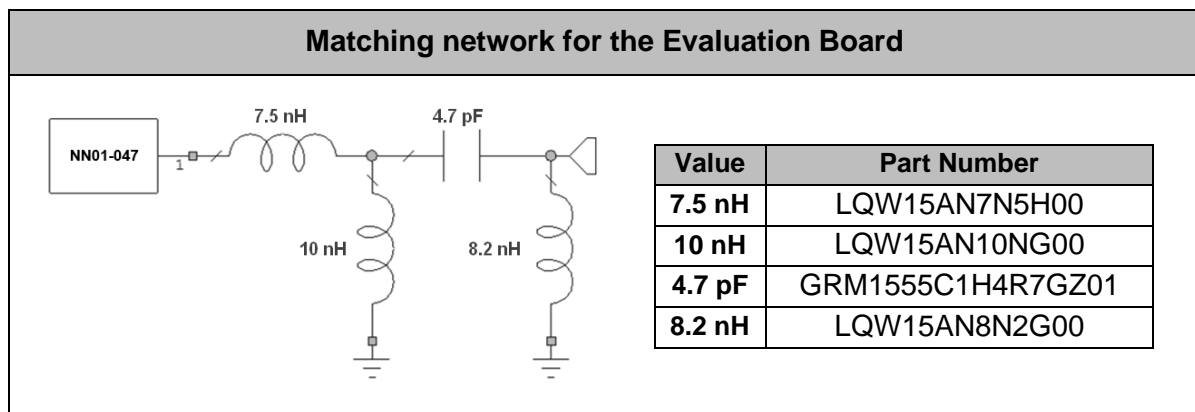

Figure 2 – Matching network implemented in the Evaluation Board.

¹ See terms and conditions for a free NN Wireless Fast-Track service in 24h at: <https://www.ignion.io/fast-track-project/>

3.3. RADIATION PATTERNS AND GAIN

GAIN	 <p>TVNow™ Performance Vs UHF DVB-H Specs</p>	 <p>TVnow™ performance in L US bands</p>
Radiation Pattern	 <p>Antenna</p> <p>PCB</p>	
Radiation Pattern		

Table 2 – Typical antenna Gain across FM bandwidth.

3.4. CAPABILITIES AND MEASUREMENT SYSTEMS

Ignion specializes in the design and manufacture of optimized antennas for wireless applications, and with the provision of RF expertise to a wide range of clients. We offer turn-key antenna products and antenna integration support to minimize your time requirements and maximize return on investment throughout the product development process. We also provide our clients with the opportunity to leverage our in-house testing and measurement facilities to obtain accurate results quickly and efficiently.

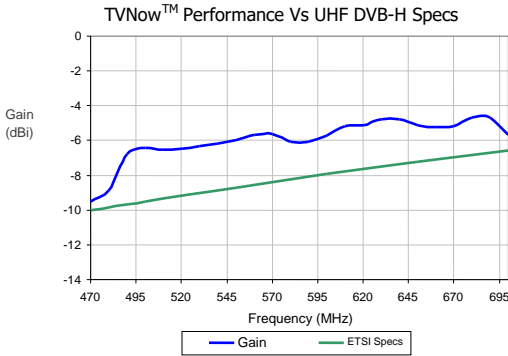
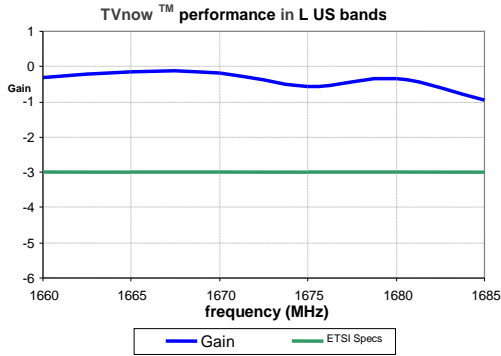
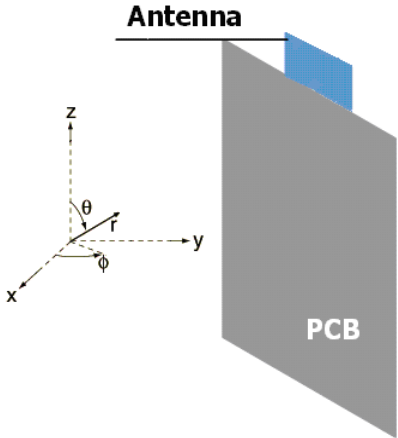
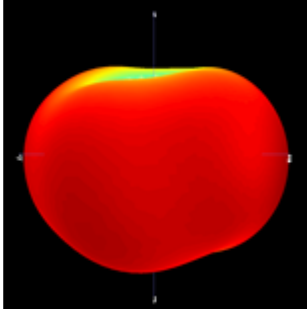
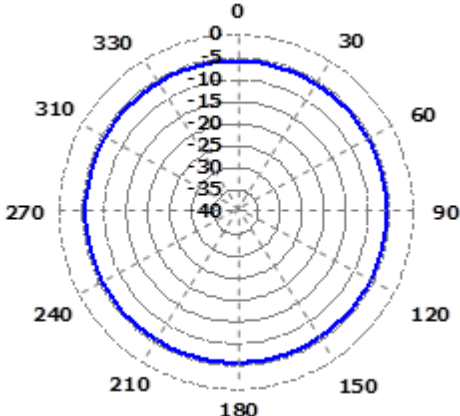
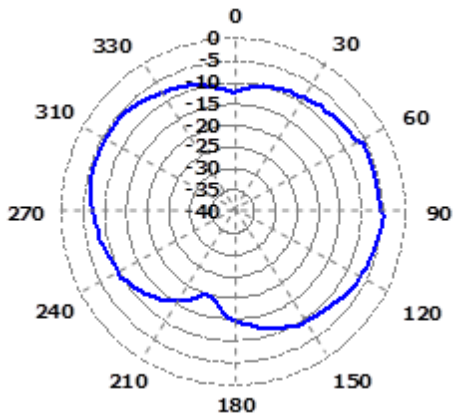
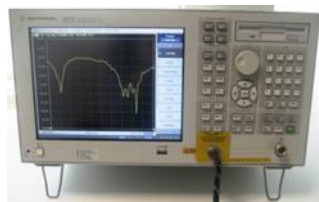

Agilent E5071B

VSWR
&
S Parameters

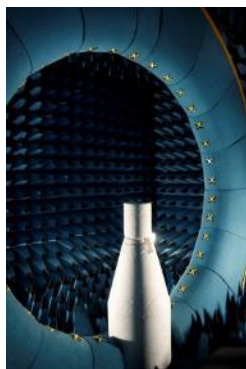
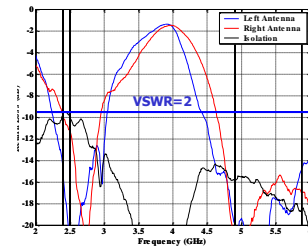

SATIMO STARGATE 32

Radiation
Pattern
&
Efficiency

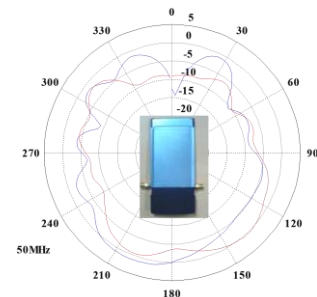

Anechoic chambers and full equipped in-house lab

4. MECHANICAL CHARACTERISTICS

4.1. DIMENSIONS AND TOLERANCES

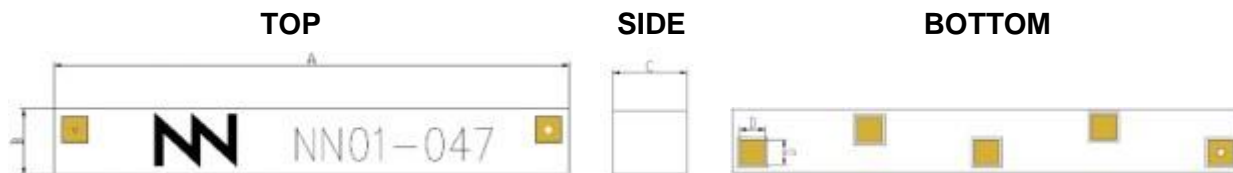

Note: all antenna pads (feed point and mounting pads) have the same dimensions

The yellow hole on the front of the antenna provides a visual cue to mounting the antenna. It is located above the feed point of the antenna and is included to decrease possible manufacturing error.

Measure	mm	Measure	mm
A	40.0 ± 0.2	C	4.8 ± 0.2
B	5.0 ± 0.2	D	2.0 ± 0.1

Figure 3 – Antenna Dimensions and Tolerances.

The TVNow[™] Dual Band (UHF+Lband) DVB-H antenna is compliant with the restriction of the use of hazardous substances (**RoHS**).

4.2. SPECIFICATIONS FOR THE INK

Next figure shows the correct colors of the antenna:

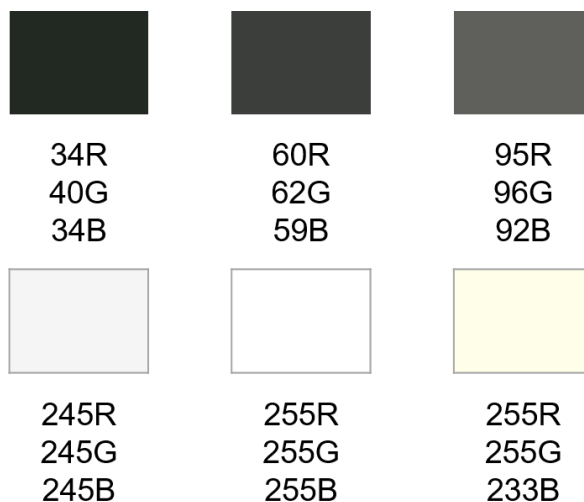

Acceptable color range

4.3. ANTENNA FOOTPRINT

This antenna footprint applies for the reference evaluation board described on page 6 of this User Manual.

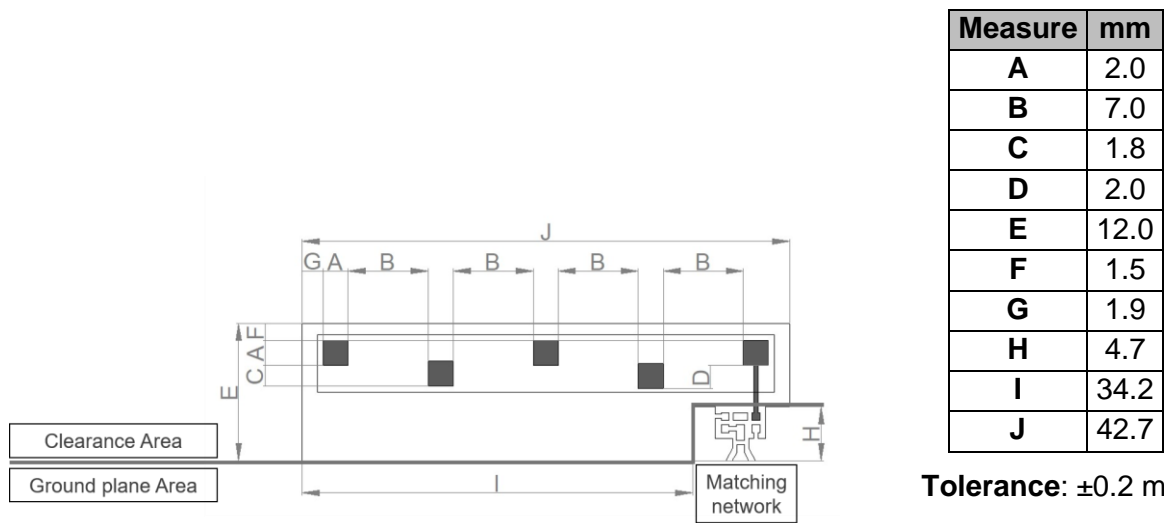

Note: all the soldering pads (feed point and mounting pads) on the antenna layout have the same dimensions.

Figure 4 – Antenna Footprint Details.

Other PCB form factors and configurations may require a different feeding configuration, feeding line dimensions and clearance areas. If you require support for the integration of the antenna in your design, please contact support@ignion.io

5. ASSEMBLY PROCESS

Figure 5 shows the back and front view of the TVNow[™] antenna, and indicates the location of the feeding point and the mounting pads:

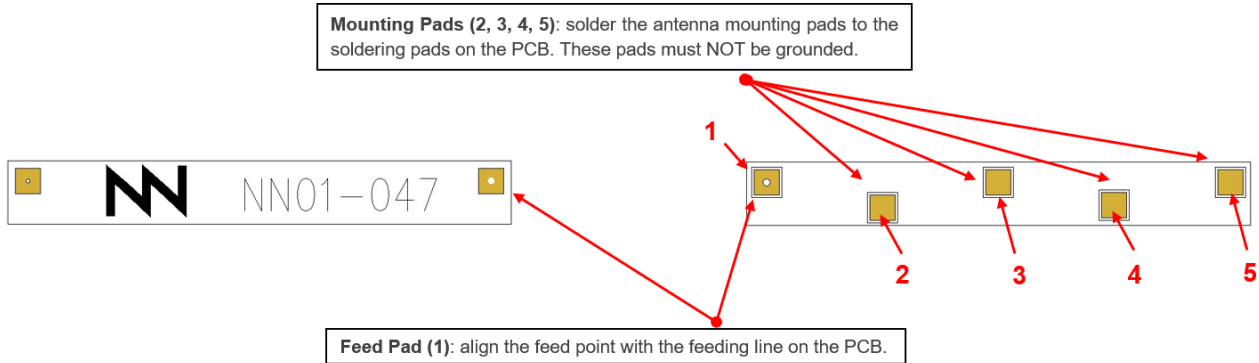

Figure 5 – Views of the TVNow[™] Dual band (UHF+Lband) DVB-H antenna.

As a surface mount device (SMD), this antenna is compatible with industry standard soldering processes. The basic assembly procedure for this antenna is as follows:

1. Apply a solder paste to the pads of the PCB. Place the antenna on the board.
2. Perform a reflow process according to the temperature profile detailed in Table 3, Figure 7 on page 13.
3. After soldering the antenna to the circuit board, perform a cleaning process to remove any residual flux. Ignion recommends conducting a visual inspection after the cleaning process to verify that all reflux has been removed.

The drawing below shows the soldering details obtained after a correct assembly process:

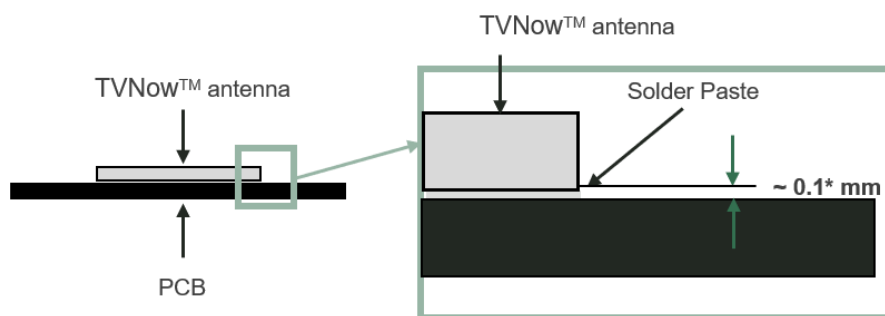

Figure 6 – Soldering Details.

NOTE(*): Solder paste thickness after the assembly process will depend on the thickness of the soldering stencil mask. A stencil thickness equal to or larger than **127 microns (5 mils)** is required.

The TVNow[™] antenna should be assembled following either Sn-Pb or Pb-free assembly processes. According to the Standard **IPC/JEDEC J-STD-020C**, the temperature profile suggested is as follows:

Phase	Profile features	Pb-Free Assembly (SnAgCu)
RAMP-UP	Avg. Ramp-up Rate (T _{smax} to T _p)	3 °C / second (max.)
PREHEAT	- Temperature Min (T _{smin}) - Temperature Max (T _{smax}) - Time (t _{smin} to t _{smax})	150 °C 200 °C 60-180 seconds
REFLOW	- Temperature (T _L) - Total Time above T _L (t _L)	217 °C 60-150 seconds
PEAK	- Temperature (T _p) - Time (t _p)	260 °C 20-40 seconds
RAMP-DOWN	Rate	6 °C/second max
Time from 25 °C to Peak Temperature		8 minutes max

Table 3 – Recommended soldering temperatures.

Next graphic shows temperature profile (grey zone) for the antenna assembly process in reflow ovens.

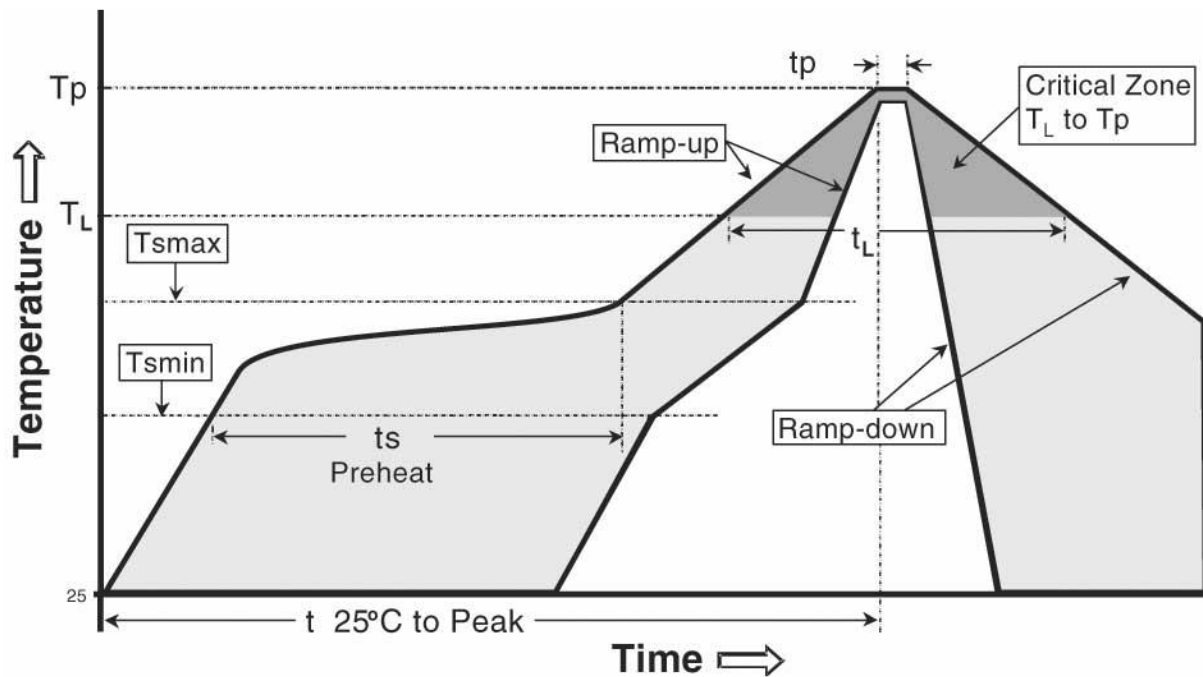

Figure 7 – Temperature profile.

6. PRODUCT CHANGE NOTIFICATION

This document is property of Ignion,
Not to disclose or copy without prior written consent

PCN Number: NN19100007

Notification Date: October 07th, 2019

Part Number identification:

Part Number changes, it will be applied in all the document of the company (User Manual, Data Sheet, ...)

Previous Part Number
FR01-B1-S-0-047

New Part Number
NN01-047

Reason for change:

<input type="checkbox"/> Specs (electrical/mechanical)	<input type="checkbox"/> Manufacturing location
<input type="checkbox"/> User Manual/Data Sheet	<input type="checkbox"/> Quality/Reliability
<input type="checkbox"/> Material/Composition	<input type="checkbox"/> Logistics
<input type="checkbox"/> Processing/Manufacturing	<input checked="" type="checkbox"/> Other: Logo, product color and Part Number

Change description

- 1.- Part Number: From FR01-B1-S-0-047 FRACTUS to NN01-047 Ignion in the User Manual
- 2.- Color: From blue/white to white/black

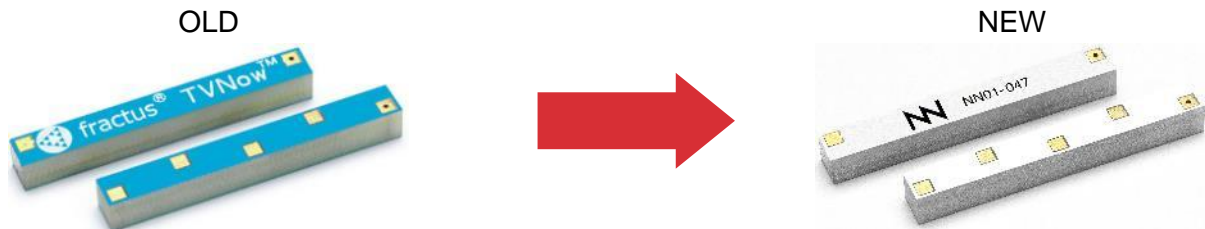

Comments:

- 1.- Electrical and Mechanical specs remain the same
- 2.- Footprint in the PCB to solder the chip antenna remains the same

Identification method

- 1.- In the chip antennas, the changes are in the color, in the logo and in the part number

User Manual	<input checked="" type="checkbox"/>	Available from: February 2020
Samples	<input checked="" type="checkbox"/>	Available from: January 2020

Ignion Contact:

Sales
Name: Josep Portabella
Email: josep.portabella@ignion.io

Supply Chain
Albert Vidal
albert.vidal@ignion.io



Your innovation.
Accelerated.

Contact:

support@ignion.io

+34 935 660 710

Barcelona

Av. Alcalde Barnils, 64-68 Modul C, 3a pl.
Sant Cugat del Vallés
08174 Barcelona
Spain

Shanghai

Shanghai Bund Centre
18/F Bund Centre, 222 Yan'an Road East,
Huangpu District
Shanghai, 200002
China

New Delhi

New Delhi, Red Fort Capital Parsvnath Towers
Bhai Veer Singh Marg, Gole Market,
New Delhi, 110001
India

Tampa

8875 Hidden River Parkway
Suite 300
Tampa, FL 33637
USA