

Hyperfast Rectifier, 75 A FRED Pt® G5

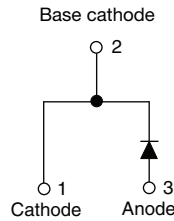

FEATURES

- Hyperfast and optimized Q_{rr}
- Best in class forward voltage drop and switching losses trade off
- Optimized for high speed operation
- 175 °C maximum operating junction temperature
- Polyimide passivation
- Material categorization: for definitions of compliance please see www.vishay.com/doc?99912

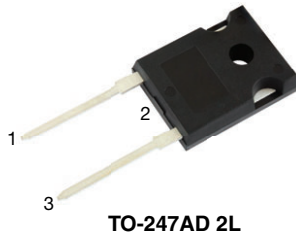

LINKS TO ADDITIONAL RESOURCES



| PRIMARY CHARACTERISTICS | |
|--------------------------|-------------|
| $I_{F(AV)}$ | 75 A |
| V_R | 600 V |
| V_F at I_F at 125 °C | 1.2 V |
| t_{rr} (typ.) | 32 |
| I_{FSM} | 615 |
| T_J max. | 175 °C |
| Package | TO-247AD 2L |
| Circuit configuration | Single |

DESCRIPTION / APPLICATIONS

Featuring a unique combination of low conduction and switching losses, this rectifier is the right choice for soft switched and resonant converters, as well as medium frequency hard switching converters. This device is specifically designed to improve efficiency of high speed LLC output rectification stages of EV / HEV battery charging stations and high frequency stages of UPS applications.

MECHANICAL DATA

Case: TO-247AD 2L

Molding compound meets UL 94 V-0 flammability rating

Terminal: matte tin plated leads, solderable per J-STD-002

| ABSOLUTE MAXIMUM RATINGS | | | | |
|--|-------------------|--|-------------|-------|
| PARAMETER | SYMBOL | TEST CONDITIONS | VALUES | UNITS |
| Repetitive peak reverse voltage | V_{RRM} | | 600 | V |
| Average rectified forward current | $I_{F(AV)}$ | $T_C = 113\text{ °C}$, $D = 0.50$ | 75 | A |
| Non-repetitive peak surge current | I_{FSM} | $T_C = 25\text{ °C}$, $t_p = 10\text{ ms}$, sine wave | 615 | |
| Repetitive peak forward current | I_{FRM} | $T_C = 113\text{ °C}$, $D = 0.50$, $f = 20\text{ kHz}$ | 150 | |
| Operating junction and storage temperature | T_J , T_{Stg} | | -55 to +175 | °C |

| ELECTRICAL SPECIFICATIONS ($T_J = 25\text{ °C}$ unless otherwise specified) | | | | | | |
|--|------------------|---|------|------|------|---------------|
| PARAMETER | SYMBOL | TEST CONDITIONS | MIN. | TYP. | MAX. | UNITS |
| Breakdown voltage, blocking voltage | V_{BR} , V_R | $I_R = 100\text{ }\mu\text{A}$ | 600 | - | - | V |
| Forward voltage | V_F | $I_F = 75\text{ A}$ | - | 1.3 | 1.7 | |
| | | $I_F = 75\text{ A}$, $T_J = 125\text{ °C}$ | - | 1.2 | - | |
| Reverse leakage current | I_R | $V_R = V_R$ rated | - | - | 25 | μA |
| | | $T_J = 125\text{ °C}$, $V_R = V_R$ rated | - | - | 500 | |
| Junction capacitance | C_T | $V_R = 200\text{ V}$ | - | 96 | - | pF |
| Series inductance | L_S | Measured to lead 5 mm from package body | - | 8 | - | nH |



| DYNAMIC RECOVERY CHARACTERISTICS ($T_J = 25\text{ }^\circ\text{C}$ unless otherwise specified) | | | | | | | |
|--|-----------|---|--|------|------|------|-------|
| PARAMETER | SYMBOL | TEST CONDITIONS | | MIN. | TYP. | MAX. | UNITS |
| Reverse recovery time | t_{rr} | $I_F = 1.0\text{ A}$, $di_F/dt = 100\text{ A}/\mu\text{s}$, $V_R = 30\text{ V}$ | | - | 32 | - | ns |
| | | $T_J = 25\text{ }^\circ\text{C}$ | | - | 52 | - | |
| | | $T_J = 125\text{ }^\circ\text{C}$ | | - | 82 | - | |
| Peak recovery current | I_{RRM} | $T_J = 25\text{ }^\circ\text{C}$ | | - | 24 | - | A |
| | | $T_J = 125\text{ }^\circ\text{C}$ | | - | 51 | - | |
| Reverse recovery charge | Q_{rr} | $T_J = 25\text{ }^\circ\text{C}$ | | - | 805 | - | nC |
| | | $T_J = 125\text{ }^\circ\text{C}$ | | - | 2515 | - | |
| Reverse recovery time | t_{rr} | $T_J = 25\text{ }^\circ\text{C}$ | | - | 57 | - | ns |
| | | $T_J = 125\text{ }^\circ\text{C}$ | | - | 90 | - | |
| Peak recovery current | I_{RRM} | $T_J = 25\text{ }^\circ\text{C}$ | | - | 28 | - | A |
| | | $T_J = 125\text{ }^\circ\text{C}$ | | - | 58 | - | |
| Reverse recovery charge | Q_{rr} | $T_J = 25\text{ }^\circ\text{C}$ | | - | 969 | - | nC |
| | | $T_J = 125\text{ }^\circ\text{C}$ | | - | 3090 | - | |

| THERMAL - MECHANICAL SPECIFICATIONS | | | | | | |
|--|-------------------|------------------------|-----------|------|------------|---------------------------|
| PARAMETER | SYMBOL | TEST CONDITIONS | MIN. | TYP. | MAX. | UNITS |
| Thermal resistance, junction-to-case | R_{thJC} | | - | - | 0.5 | $^\circ\text{C}/\text{W}$ |
| Weight | | | - | 5.5 | - | g |
| Mounting torque | | | 6 (5) | - | 12 (10) | kgf · cm (lbf · in) |
| Maximum junction and storage temperature range | T_J , T_{Stg} | | -55 | - | 175 | $^\circ\text{C}$ |
| Marking device | | Case style TO-247AD 2L | E5PH7506L | | | |

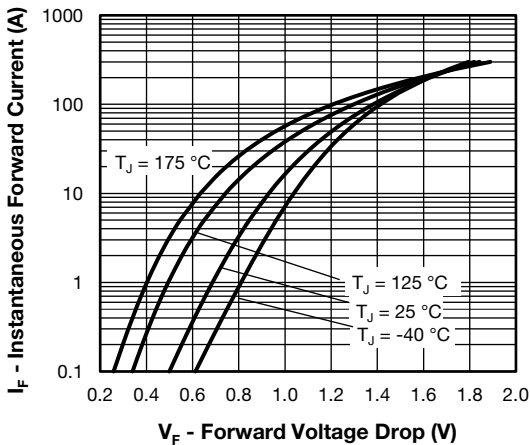

Fig. 1 - Forward Voltage Drop Characteristics, Per Leg

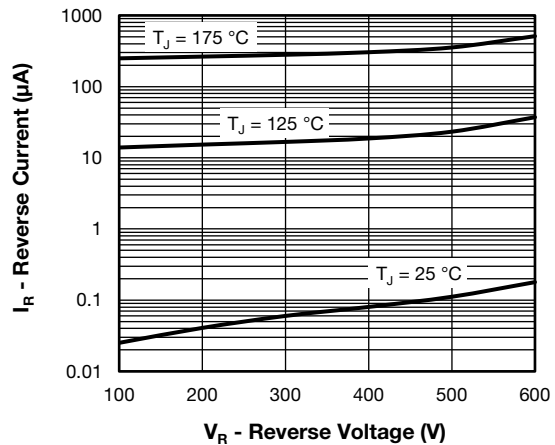

Fig. 2 - Typical Values of Reverse Current vs. Reverse Voltage, Per Leg

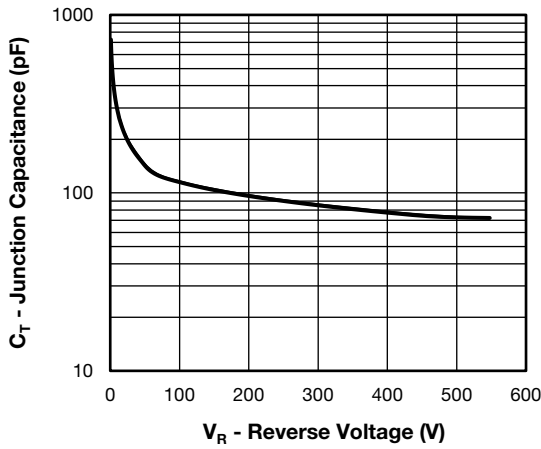

Fig. 3 - Typical Junction Capacitance vs. Reverse Voltage, Per Leg

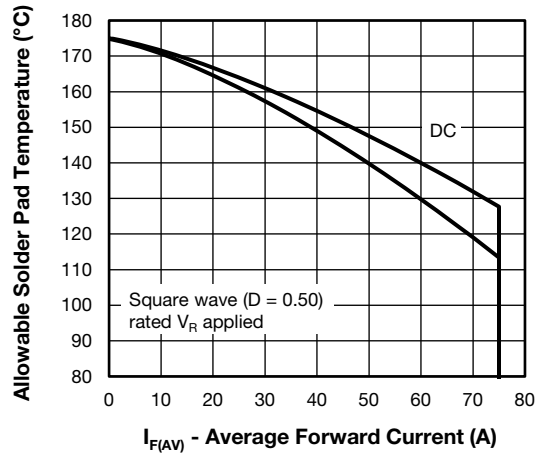

Fig. 4 - Maximum Allowable Case Temperature vs. Average Forward Current, Per Leg

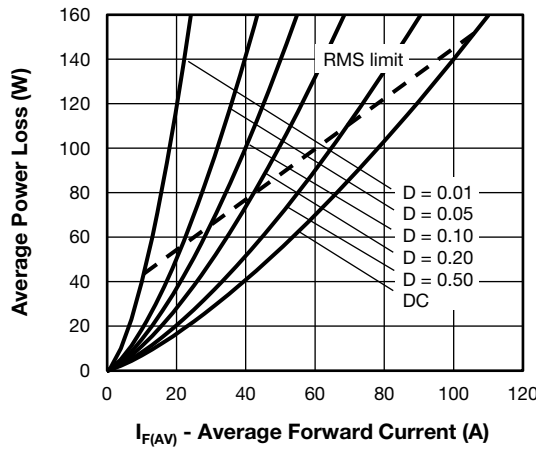

Fig. 5 - Forward Power Loss Characteristics, Per Leg

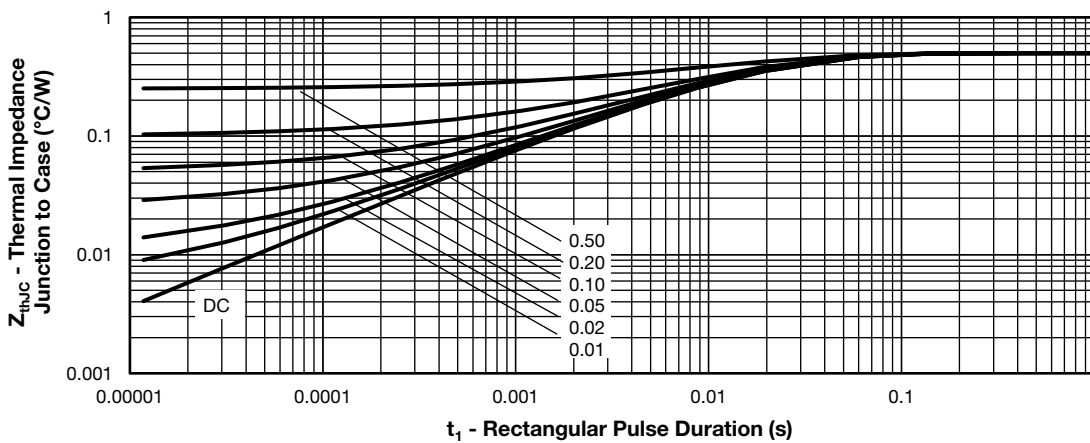

Fig. 6 - Transient Thermal Impedance, Junction to Case, Per Leg

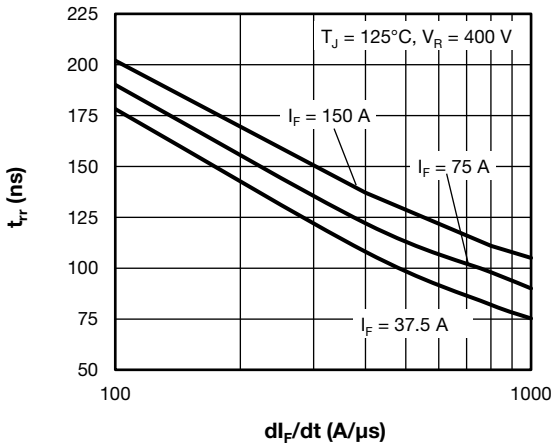

Fig. 7 - Typical Reverse Recovery Time vs. di_F/dt , Per Leg

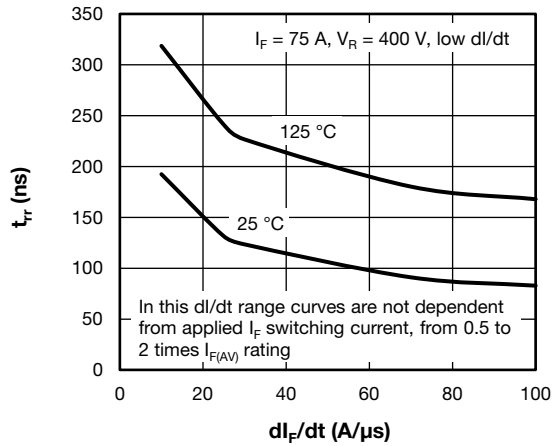

Fig. 10 - Typical Reverse Recovery Time vs. di_F/dt , Per Leg

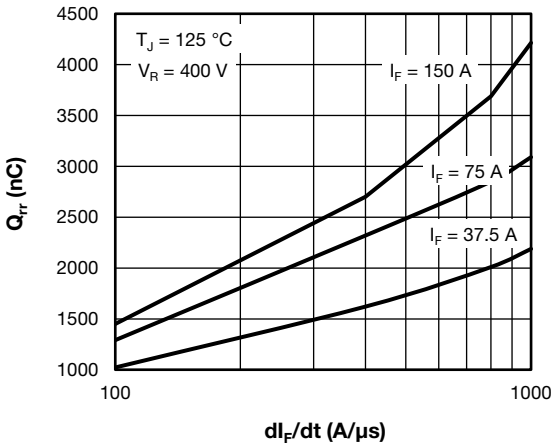

Fig. 8 - Typical Reverse Recovery Charge vs. di_F/dt , Per Leg

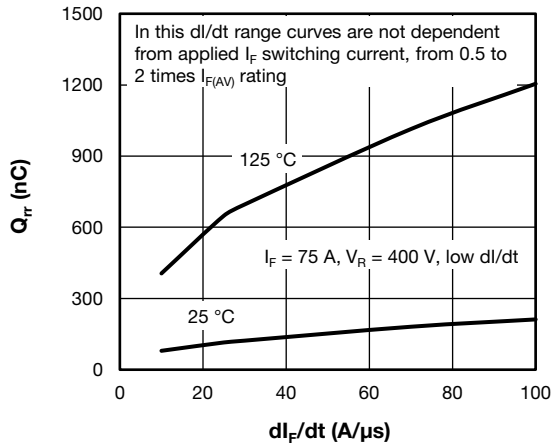

Fig. 11 - Typical Reverse Recovery Charge vs. di_F/dt , Per Leg

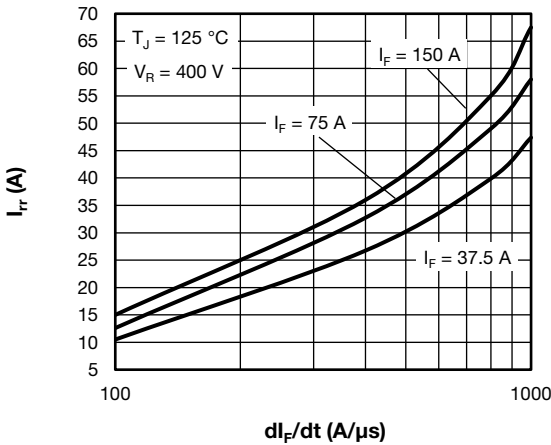

Fig. 9 - Typical Reverse Recovery Current vs. di_F/dt , Per Leg

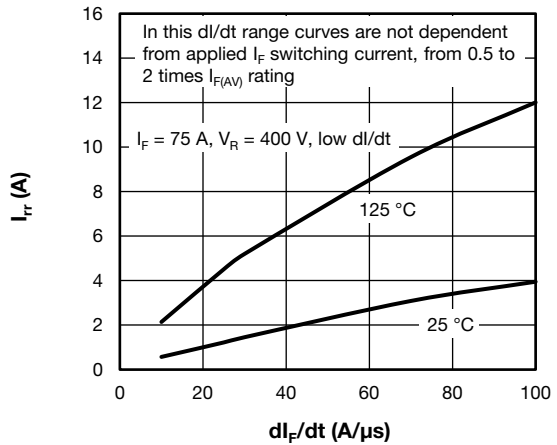

Fig. 12 - Typical Reverse Recovery Current vs. di_F/dt , Per Leg

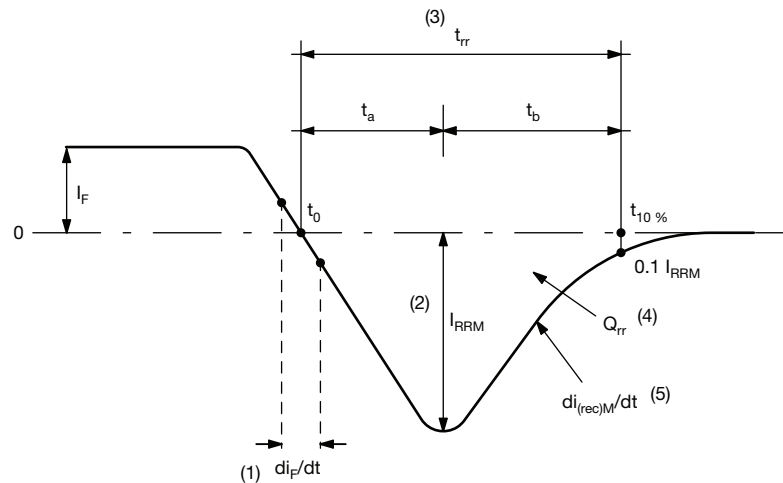

Fig. 13 - Reverse Recovery Waveform and Definitions

Notes

- (1) di_F/dt - rate of change of current through zero crossing
- (2) I_{RRM} - peak reverse recovery current
- (3) t_{rr} - reverse recovery time measured from t_0 , crossing point of negative going I_F , to point $t_{10\%}$, $0.1 I_{RRM}$
- (4) Q_{rr} - area under curve defined by t_0 and $t_{10\%}$

$$Q_{rr} = \int_{t_0}^{t_{10\%}} I(t) dt$$

- (5) $di_{(rec)M}/dt$ - peak rate of change of current during t_b portion of t_{rr}

ORDERING INFORMATION TABLE

| | | | | | | | | | |
|-------------|------------|----------|----------|----------|----------|-----------|-----------|----------|------------|
| Device code | VS- | E | 5 | P | H | 75 | 06 | L | -N3 |
| | (1) | (2) | (3) | (4) | (5) | (6) | (7) | (8) | (9) |

- 1** - Vishay Semiconductors product
- 2** - E = single diode
- 3** - 5 = Fred generation 5
- 4** - Package:
P = TO-247 package
- 5** - H = hyperfast recovery
- 6** - Current rating (75 = 75 A)
- 7** - Voltage rating (06 = 600 V)
- 8** - Package: L = long lead (TO-247AD)
- 9** - Environmental digit:
-N3 = halogen-free, RoHS-compliant, and totally lead (Pb)-free

| ORDERING INFORMATION (Example) | | | |
|---------------------------------------|-------------------|------------------------|-------------------------|
| PREFERRED P/N | QUANTITY PER TUBE | MINIMUM ORDER QUANTITY | PACKAGING DESCRIPTION |
| VS-E5PH7506L-N3 | 25 | 500 | Antistatic plastic tube |

| LINKS TO RELATED DOCUMENTS | |
|-----------------------------------|--|
| Dimensions | www.vishay.com/doc?95536 |
| Part marking information | www.vishay.com/doc?95648 |

TO-247AD 2L

DIMENSIONS in millimeters and inches

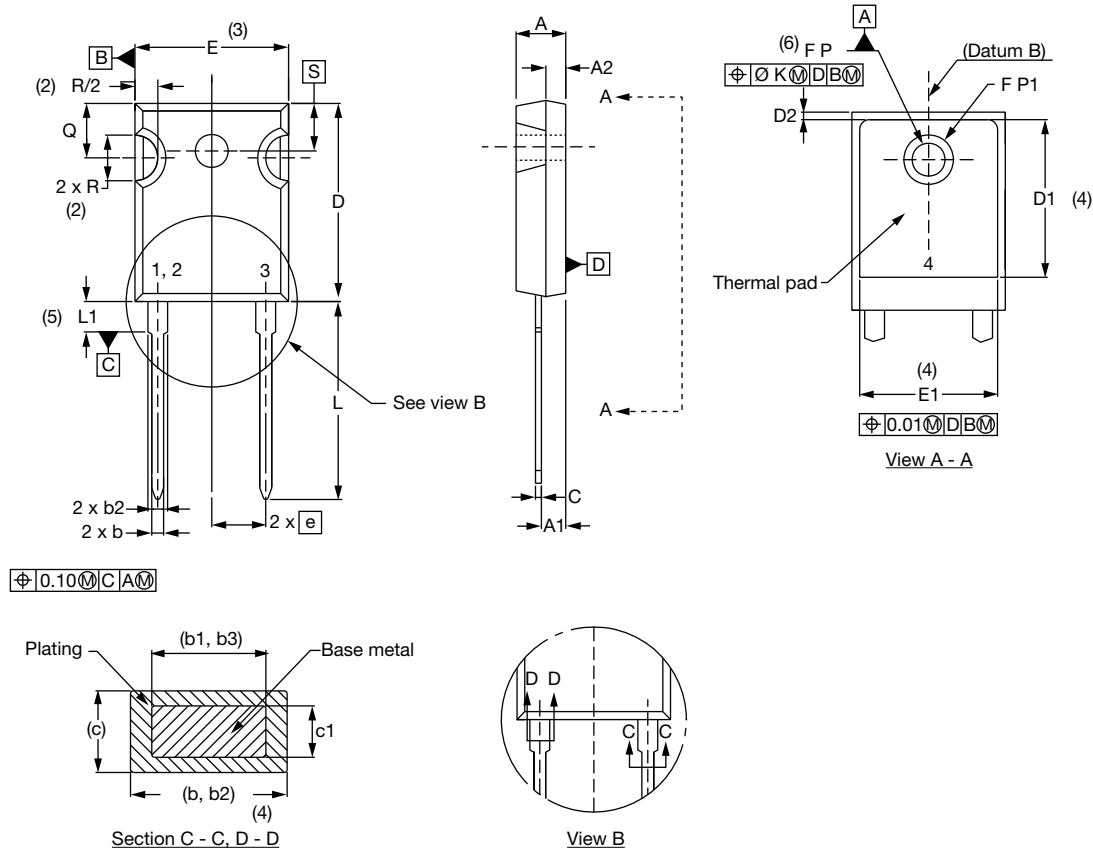

| SYMBOL | MILLIMETERS | | INCHES | | NOTES | SYMBOL | MILLIMETERS | | INCHES | | NOTES |
|--------|-------------|-------|--------|-------|-------|--------|-------------|-------|-----------|-------|-------|
| | MIN. | MAX. | MIN. | MAX. | | | MIN. | MAX. | MIN. | MAX. | |
| A | 4.65 | 5.31 | 0.183 | 0.209 | | E | 15.29 | 15.87 | 0.602 | 0.625 | 3 |
| A1 | 2.21 | 2.59 | 0.087 | 0.102 | | E1 | 13.46 | - | 0.53 | - | |
| A2 | 1.50 | 2.49 | 0.059 | 0.098 | | e | 5.46 BSC | | 0.215 BSC | | |
| b | 0.99 | 1.40 | 0.039 | 0.055 | | Ø K | 0.254 | | 0.010 | | |
| b1 | 0.99 | 1.35 | 0.039 | 0.053 | | L | 19.81 | 20.32 | 0.780 | 0.800 | |
| b2 | 1.65 | 2.39 | 0.065 | 0.094 | | L1 | 3.71 | 4.29 | 0.146 | 0.169 | |
| b3 | 1.65 | 2.34 | 0.065 | 0.092 | | Ø P | 3.56 | 3.66 | 0.14 | 0.144 | |
| c | 0.38 | 0.89 | 0.015 | 0.035 | | Ø P1 | - | 6.98 | - | 0.275 | |
| c1 | 0.38 | 0.84 | 0.015 | 0.033 | | Q | 5.31 | 5.69 | 0.209 | 0.224 | |
| D | 19.71 | 20.70 | 0.776 | 0.815 | 3 | R | 4.52 | 5.49 | 0.178 | 0.216 | |
| D1 | 13.08 | - | 0.515 | - | 4 | S | 5.51 BSC | | 0.217 BSC | | |
| D2 | 0.51 | 1.35 | 0.020 | 0.053 | | | | | | | |

Notes

- (1) Dimensioning and tolerancing per ASME Y14.5M-1994
- (2) Contour of slot optional
- (3) Dimension D and E do not include mold flash. These dimensions are measured at the outermost extremes of the plastic body
- (4) Thermal pad contour optional with dimensions D1 and E1
- (5) Lead finish uncontrolled in L1
- (6) Ø P to have a maximum draft angle of 1.5 to the top of the part with a maximum hole diameter of 3.91 mm (0.154")
- (7) Outline conforms to JEDEC® outline TO-247 with exception of dimension A min., D, E min., Q min., S, and note 4



Disclaimer

ALL PRODUCT, PRODUCT SPECIFICATIONS AND DATA ARE SUBJECT TO CHANGE WITHOUT NOTICE TO IMPROVE RELIABILITY, FUNCTION OR DESIGN OR OTHERWISE.

Vishay Intertechnology, Inc., its affiliates, agents, and employees, and all persons acting on its or their behalf (collectively, "Vishay"), disclaim any and all liability for any errors, inaccuracies or incompleteness contained in any datasheet or in any other disclosure relating to any product.

Vishay makes no warranty, representation or guarantee regarding the suitability of the products for any particular purpose or the continuing production of any product. To the maximum extent permitted by applicable law, Vishay disclaims (i) any and all liability arising out of the application or use of any product, (ii) any and all liability, including without limitation special, consequential or incidental damages, and (iii) any and all implied warranties, including warranties of fitness for particular purpose, non-infringement and merchantability.

Statements regarding the suitability of products for certain types of applications are based on Vishay's knowledge of typical requirements that are often placed on Vishay products in generic applications. Such statements are not binding statements about the suitability of products for a particular application. It is the customer's responsibility to validate that a particular product with the properties described in the product specification is suitable for use in a particular application. Parameters provided in datasheets and / or specifications may vary in different applications and performance may vary over time. All operating parameters, including typical parameters, must be validated for each customer application by the customer's technical experts. Product specifications do not expand or otherwise modify Vishay's terms and conditions of purchase, including but not limited to the warranty expressed therein.

Hyperlinks included in this datasheet may direct users to third-party websites. These links are provided as a convenience and for informational purposes only. Inclusion of these hyperlinks does not constitute an endorsement or an approval by Vishay of any of the products, services or opinions of the corporation, organization or individual associated with the third-party website. Vishay disclaims any and all liability and bears no responsibility for the accuracy, legality or content of the third-party website or for that of subsequent links.

Except as expressly indicated in writing, Vishay products are not designed for use in medical, life-saving, or life-sustaining applications or for any other application in which the failure of the Vishay product could result in personal injury or death. Customers using or selling Vishay products not expressly indicated for use in such applications do so at their own risk. Please contact authorized Vishay personnel to obtain written terms and conditions regarding products designed for such applications.

No license, express or implied, by estoppel or otherwise, to any intellectual property rights is granted by this document or by any conduct of Vishay. Product names and markings noted herein may be trademarks of their respective owners.