

XPOW-40AX-CCvCV-U

SPECIFICATION SHEET AND MANUAL

2022

nicslab

CE RoHS

Version: 13.5

Date: 17 November 2022

Important Notice and Disclaimer:

No part of this document may be reproduced in any form or by any means (including electronic storage and retrieval or translation into a foreign language) without prior agreement and written consent from Nicslab. No responsibility is assumed by Nicslab for its use, nor for any infringements of patents or other rights of third parties that may result from its use. Trademarks and registered trademarks are the property of their respective owners.

This product is designated for skilled users. You are entirely responsible for (1) choosing the appropriate Nicslab products for your operation, (2) designing, validating, and testing your operation, (3) ensuring your operation meets applicable standards, and any other safety, security, or other requirements.

Copyright © 2022, Nicslab.

Safety Note

Do not operate this product in any manner not specified by Nicslab. Failure to comply with these precautions or with specific warnings or instructions elsewhere in this manual violates safety standards of design, manufacture, and intended use of the instrument. Nicslab assumes no responsibility for any damage caused by mishandling that is beyond normal usage defined in this manual of this product.

Before Applying DC Power Supply

Verify that the DC power supply is in good condition and safe to use. It is imperative to use ONE DC power supply as a source power for this product and the input voltage is no more than 36 V, or it can impair this product. Make all connections to the unit before applying power.

Do Not Discard the Instrument Cover

Only authorized personnel from Nicslab should remove the instrument cover.

Do Not Alter the Instrument

Do not put any unauthorized parts or modify the instrument without Nicslab approval and warranty.

Caution

This symbol indicates the hazard of any operating procedure, practice, or the like that, if not correctly performed or adhered to, could result in damage to the product or loss of important data.

Contents

List of Tables	4
List of Figures	4
1. Introduction	5
2. Hardware	7
Specification Conditions	7
Hardware Requirement	7
Box Descriptions	8
XPOW-40AX-CCvCV-U Specifications	11
Hardware Installation	13
3. Software and Graphical User Interface (GUI)	14
Software Requirement	14
Software Installation	14
How to Detect Which COM Is Used (<i>Windows only</i>)	15
Graphical User Interface (GUI)	15
Initializing the GUI	18
Premium Upgrade	18
Constant Current (CC) Mode	20
Constant Voltage (CV) Mode	20
Save and Upload	21
Sequence Automation	23
Record	24
Setting Voltage and Current Limit	25
Setting Voltage Range	26
Setting Reading Speed	26
Value Increment Setting	26
4. Operating XPOW through the SCPI command	27
Python Installation (Example)	27
Run Python Code (Example)	27
Python Function (Example)	29
SCPI Commands	32
5. System Shutdown	37
6. Troubleshooting	38

7.	Warranty	39
8.	Compliance	39
9.	Contact	39

List of Tables

Table 1.	Checklist Items	6
Table 2.	Specification Conditions	7
Table 3.	DAC Voltage Performance Specification	11
Table 4.	DAC Current Performance Specifications	12
Table 5.	Troubleshooting	38

List of Figures

Figure 1.	XPOW-40AX-CCvCV-U System Diagram	6
Figure 2.	Product Dimension	8
Figure 3.	Front and Back Panel	9
Figure 4.	GUI	16

1. Introduction

Nicslab XPOW-40AX-CCvCV-U is a versatile multichannel source measurement system. The XPOW-40AX-CCvCV-U supports multiple voltage/current sourcing and voltage/current measurement. The system is suitable for sourcing and measuring low-power applications from simple electronic circuits to complex photonic integrated circuits.

The XPOW-40AX-CCvCV-U provides independent 40 channels controlled by Graphical User Interface (GUI) and Standard Commands for Programmable Instruments (SCPI) through Universal Serial Bus (USB) port. The system has two modes: Constant Current (CC) ranging from 0 – 300 mA per channel and Constant Voltage (CV) ranging from unipolar 0 – 5 Volt, 0 – 10 Volt, 0 – 20 Volt, and 0 – 36 Volt.

The features for XPOW-40AX-CCvCV-U in detail are:

- 16-bit voltage control.
- 16-bit current control.
- Enable voltage range configuration through software (technology that enables the user to select the output range with software without losing control of the high-resolution feature).
- Flexible output configuration with 16-bit resolution unipolar 0 – 5 V, 0 – 10 V, 0 – 20 V, and 0 – 36 V (*Premium Upgrade*).
- Intuitive GUI.
- Multi-connectors according to your application (Optional).
- The maximum power output per channel is 10 watts.
- Real-time voltage and current reading.
- Save function to create a database.
- Upload function to generate the registrable voltage and current pattern.
- Sequence function for continuous voltage and current.
- Short circuits protection.
- SCPI command support (Python, Matlab, C#, and LabVIEW).
- SCPI Library (*Premium Upgrade*).
- Windows, Mac, and Linux support.
- USB port with USB line termination, filtering, and electrostatic discharge (ESD) protection.
- Bi-directional electromagnetic interference (EMI) filtering prevents noise from entering/leaving the system.
- Compliance with IEC61000-4-2 ESD Protection for USB Port.

The XPOW-40AX-CCvCV-U needs to be connected with direct current (DC) power first then you can plug it into the Device-Under-Test (DUT) or multi-connector. The voltage/current can be controlled through GUI or SCPI command via USB port.

The system diagram is as follows:

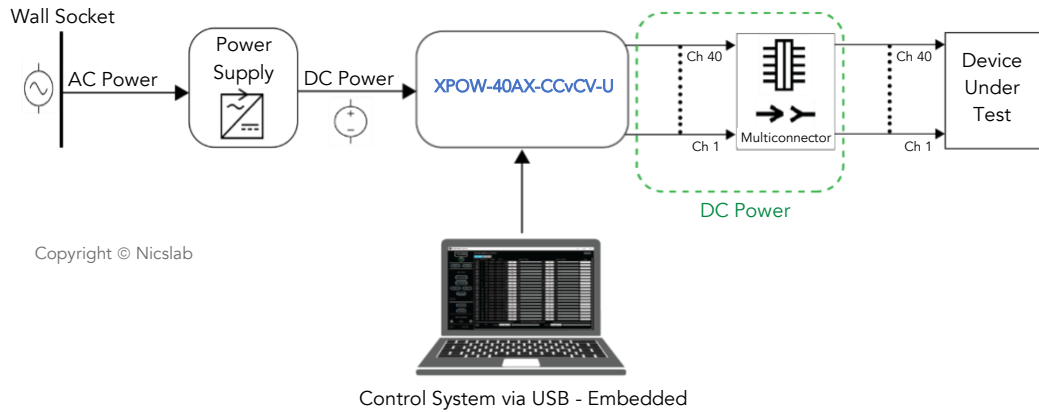

Figure 1. XPOW-40AX-CCvCV-U System Diagram

The package should include the following items:

Table 1. Checklist Items

No	Item	Qty (pc)	Checklist
1	XPOW-40AX-CCvCV-U Box	1	
2	DC power line cord (Red, Green, Black)	3	
3	USB 3.0 cable type B	1	
4	Multi-connector 1 (Optional)	1	
5	Ribbon rainbow cable	2	
6	USB flash disk	1	
7	Inside USB flash disk: a. GUI b. Specification & Manual c. Test Report d. Serial key (Upgrade) e. XPOW key f. Software Library (Premium) g. Comma-separated values (CSV) template (upload, demo sequence)	1	

2. Hardware

Specification Conditions

The operating and measurement conditions are under the following conditions:

Table 2. Specification Conditions

Items	Conditions
Room Temperature	0 ~ 40 °C
Humidity	5 ~ 80 % (No Condensing)
Power Supply Input	DC Supply Max 36 V (potential at red & black DC in). Required headroom 1.4 – 2 V.
Waterproof/Dustproof	To be operated under room condition
Calibration period	2 years

Hardware Requirement

The requirements for the PC/Laptop to be used for this product installation are:

- Resolution Minimum 1024 x 768 pixel
- Hard disk Minimum 500 MB of available free space (32-bit and 64-bit operating system)
- USB Port USB 2.0
- RAM Minimum 2 GB
- CPU 2.4 GHz or faster

Box Descriptions

The box size is 232 (W) x 333 (L) x 102(H) mm, as the pictures below:

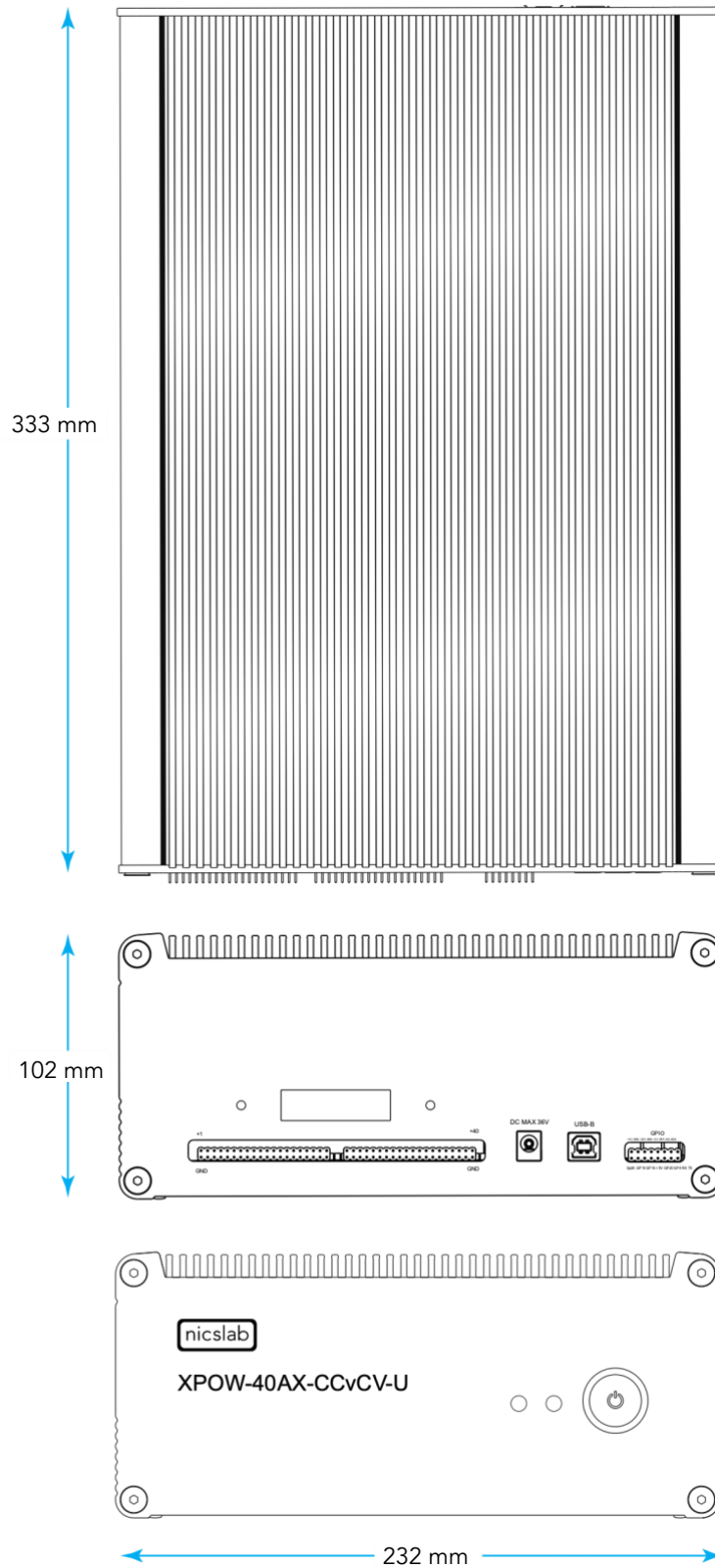

Figure 2. Product Dimension

The details of the front and back panels of the box are described below:

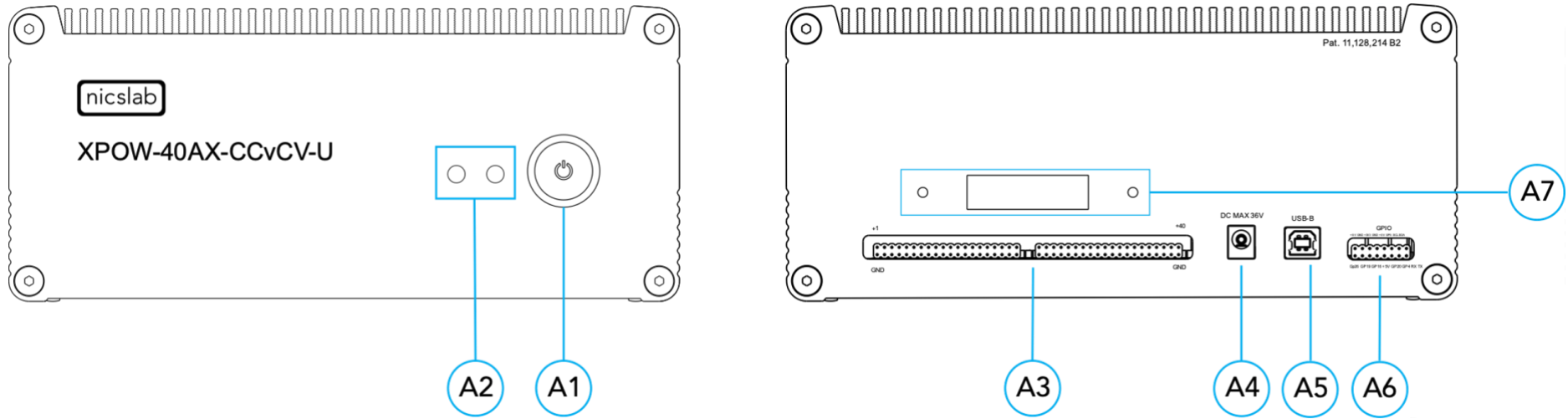

Figure 3. Front and Back Panel

Note:

A1	Power Switch	Turns the instrument on or off.
A2	Indicator Light	Green = Power Indicator. Blue = Serial Transfer Data Active.
A3	Pin Output (40 channels)	To connect to Device Under Test (DUT) using cable or multi-connector.
A4	Input DC Max 36 V	Caution Please follow the safety notice on your DC power supply. The DC input is no more than 36 V. Black cable inserts to GND Red cable inserts to 36 V
A5	USB B	USB type B minimum version 2.0.
A6	GPIO	You may use it for external control and monitoring directly to the microprocessor.
A7	Airflow	For air circulation inside the box.

XPOW-40AX-CCvCV-U Specifications

The performance specifications of the Digital Analog Converter (DAC) voltage are listed in Table 3 below:

Table 3. DAC Voltage Performance Specification

No	Parameter	Min	Typ	Max	Unit	Test conditions/comments
1	Resolution	16			Bits	
2	Integral nonlinearity (INL)	-1	± 0.5	1	LSB	All ranges, except 0 to 40
3	Differential Nonlinearity (DNL)	-1	± 0.5	1	LSB	Specified 16-bit monotonic
4	Total unadjusted error	-0.1	± 0.01	0.1	%FSR	All ranges
5	Unipolar offset error	-0.03	± 0.015	0.03	%FSR	All unipolar ranges
6	Unipolar zero-code error	0	0.04	0.1	%FSR	All unipolar ranges
7	Full-scale error	-0.2	± 0.075	± 0.2	%FSR	All ranges
8	Gain error	-0.1	± 0.02	0.1	%FSR	All ranges
9	Unipolar offset error drift		±2		ppm of FSR/°C	All unipolar ranges
10	Gain error drift		±2		ppm of FSR/°C	All ranges
11	Output voltage drift over time		5		Ppm of FSR	T _A = 40 °C, Full-scale code, 1900 hours
DYNAMIC PERFORMANCE						
12	Output Voltage Settling Time		12		µs	¼ to ¾ and ¾ to ¼ scale setting time to ± 1 LSB, ±10 V range, R _L = 5 kΩ, C _L = 200 pF
13	Slew Rate		4		V/µs	All ranges except 0 to 5 V
14	Power-on glitch magnitude		0.3		V	Power-down to active DAC output, Midscale code, R _L = 5 kΩ, C _L = 200 pF
15	Output noise		15		µV p-p	0.1 Hz to 10 Hz, Midscale code, 0 to 5 V range
16	Output noise density		78		nV/√Hz	1 kHz, Midscale code, 0 to 5 V range
17	AC PSRR		1		LSB/V	Midscale code, frequency = 60 Hz, amplitude 200 mVpp superimposed on V _{DD} , V _{CC} , or V _{SS}
18	DC PSRR		1		LSB/V	Midscale code, V _{DD} = 5 V, V _{CC} = 20 V ± 5 %, V _{SS} = 20 V
19	Code change glitch impulse		4		nV-s	1 LSB change around the major carrier, 0 to 5 V range
20	Channel to Channel AC crosstalk		4		nV-s	0 to 5 V range. Measured channel at midscale. Full-scale swing on all other channels.
21	Channel to Channel DC crosstalk		0.25		LSB	0 to 5 V range. Measured channel at midscale. All other channels at full-scale.
22	Digital feedthrough		1		nV-s	0 to 5 V range, Midscale code, F _{SCLK} = 1 MHz

The performance specifications of the Digital Analog Converter (DAC) current are listed in Table 4 below:

Table 4. DAC Current Performance Specifications

No	Parameter	Min	Typ	Max	Unit	Test conditions/comments
1	Resolution	16			Bits	
2	Monotonicity	16			Bits	
3	Differential Nonlinearity		± 0.2	± 1	LSB	
4	Integral Nonlinearity		± 12	± 64	LSB	
5	Offset Error Current		± 0.1	± 0.4	%FSR	
6	V _{ref} Temperature Coefficient		± 10		ppm/°C	
7	Gain Error		± 0.3	± 0.9	%FSR	300 mA Range
8	Gain Temperature Coefficient		30		%FSR	FSADJ = VCC
9	Total Unadjusted Error		± 0.4	± 1.4	%FSR	300 mA Range
10	Power Supply Rejection Ratio		± 2.2		LSB	100 mA; I _{OUT} = 50 mA
11	DC Crosstalk		±14		LSB	Due to a 200 mW Change in Dissipated Power
12	DC Performance					
13	V _{DROPOUT}		1.15	1.751	V	300 mA Range
14	Hi-Z Output Leakage Current		0.1	1	µA	
AC CHARACTERISTIC						
16	t _{SET}		4.7		µs	Settling time, Full-Scale 200 mA range
17	Glitch Impulse		180		pA.s	At Mid-Scale Transition, 200 mA Range
18	DAC-to-DAC Crosstalk		150		pA.s	100 mA to 200 mA Step, R _{load} = 15 Ω
19	I _{noise}					Output Current Noise Density Internal Reference, I _{out} = 150 mA, R _{load} = 4 Ω, C _{load} = 10 µF
20			12			f = 1 kHz
21			5		nA√Hz	f = 10 kHz
22			0.5	n	nA√Hz	f = 100 kHz
23			0.05		nA√Hz	f = 1 MHz

Hardware Installation

This section describes how to install XPOW-40AX-CCvCV-U and how to connect your Device Under Test (DUT) to the output terminals.

The steps are as follows:

1. Precondition step: connect to the DC power supply (max 36 V). Make certain that the DC power supply is always 'ON'.
2. Connect a USB cable to your workstation (PC/Laptop) via a USB port.
3. Connect XPOW output to the multi-connector (optional, see the M1 manual) and your Device Under Test (DUT).
4. Install the software/GUI (see the Software Installation section) from the flash disk, Dropbox link, or [Nicslab website](#).
5. After you install the software/GUI, then the XPOW is ready to use by switching the ON/OFF button at the front panel.

3. Software and Graphical User Interface (GUI)

Software Requirement

The GUI software is suitable for the following operating systems:

- Windows® 7 (32-bit, 64-bit).
- Windows® 10 (32-bit, 64-bit).
- Windows® 11 (64-bit).
- macOS 11 Big Sur.

Software Installation

The first step is to copy the GUI file into your hard disk. For Mac, both the GUI and Arduino must be copied inside the 'Application' folder.

Double-click the icon below to install the GUI.

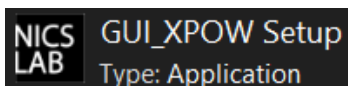

At the end step of the installation, check a 'Create a desktop shortcut'.

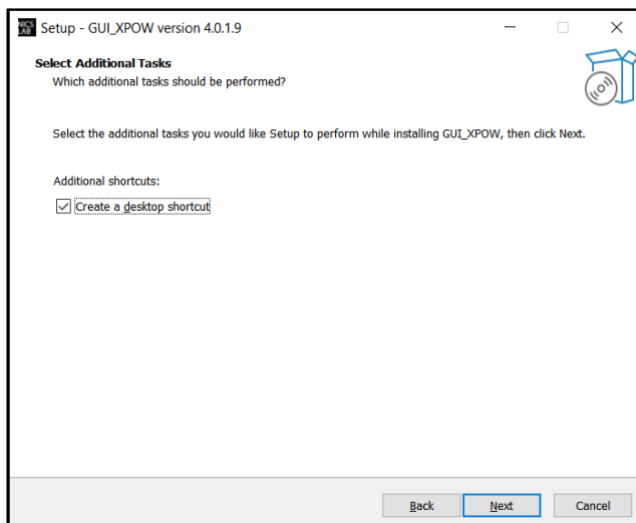

Double-click the executable GUI icon (as below) on your desktop to launch the GUI.



How to Detect Which COM Is Used (*Windows only*)

1. Click **Start** . Find 'Device Manager', and then click **Device Manager**.

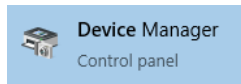

2. Find **Ports (COM & LPT)**.

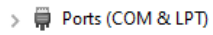

3. When XPOW is connected to the computer, there are 3 (three) Arduino Leonardo ports detected with COM number as shown below.

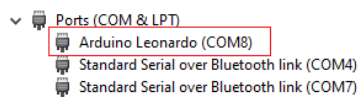

Graphical User Interface (GUI)

Start the XPOW by pressing the ON button, then you can control it by GUI, the display details are on the next page.

Note: You can also launch the GUI through programming languages such as Python, C#, LabVIEW, and Java.

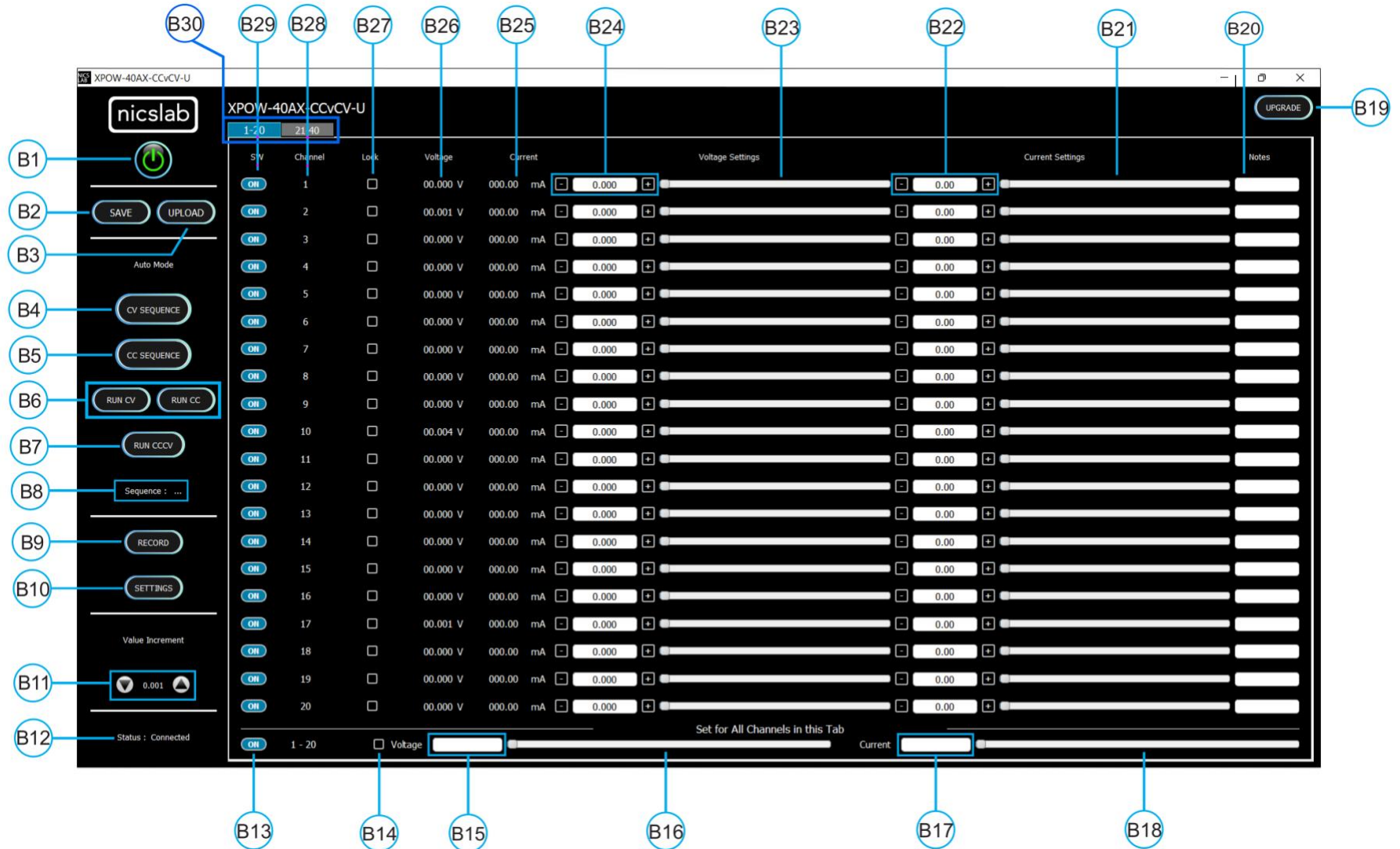

Figure 4. GUI

Note:

Callout	Description
B1	ON/OFF Switch
B2	Save File Button - <i>Premium Feature</i>
B3	Upload File Button - <i>Premium Feature</i>
B4	Auto Feature Sequence: Upload Table Button CV Mode - <i>Premium Feature</i>
B5	Auto Feature Sequence: Upload Table Button CC Mode - <i>Premium Feature</i>
B6	Auto Feature: Run Button CV and CC Mode separately - <i>Premium Feature</i>
B7	Auto Feature: Run Button CV and CC Mode combined - <i>Premium Feature</i>
B8	Name of the Sequence - <i>Premium Feature</i>
B9	Record Data Button - <i>Premium Feature</i>
B10	Setting for: <ol style="list-style-type: none"> 1. Set Limit voltage and current values - <i>Premium Feature</i> 2. V Range (16-bit precision for every range of voltages: 5, 10, 20, 36 V) - <i>Premium Feature</i> 3. Set the Reading speed of Voltage and Current (Fast, Medium, Slow) - <i>Premium Feature</i>
B11	Increment Settings
B12	Status of connection
B13	ON/OFF Button for the current Tab
B14	Enable/Disable (Lock) Channel Controller for all channels in the current tab
B15	Text area to set the voltage for all channels in the current tab
B16	Slider to set the voltage for all channels in the current tab
B17	Text area to set current for all channels in the current tab
B18	Slider to set current for all channels in the current tab
B19	Upgrade Button
B20	Notes - <i>Premium Feature</i>
B21	Current Settings Slider
B22	Current Value Based on Increment Setting
B23	Voltage Settings Slider
B24	Voltage Value Based on Increment Setting
B25	Current Value
B26	Voltage Value
B27	Enable/Disable (Lock) Channel Controller
B28	Number of channels
B29	ON/OFF Button per Channel
B30	Tab Channel

Initializing the GUI

This section shows how to initialize the GUI:

1. Launch the GUI by double-clicking the executable GUI icon.
2. When you launch the GUI for the first time, input the 'XPOW Key' and choose the correct 'COM' port.

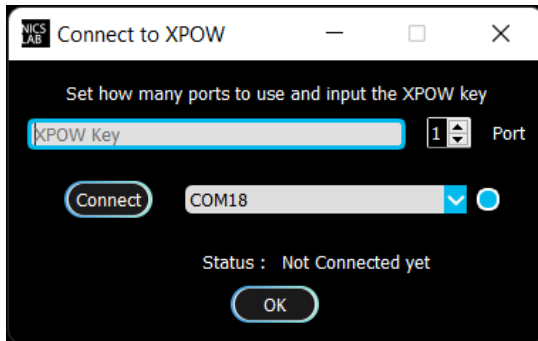

3. Press the switch button (B1) on GUI to connect it with the XPOW.



4. Turn ON (B29) on each channel to the input voltage and current values.

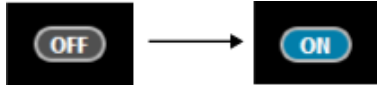

Premium Upgrade

This section shows how to upgrade the GUI to enable advanced features.

1. Press the upgrade button at the top right corner of the window

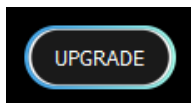

2. After the upgrade window opened, input the Premium Upgrade Key.

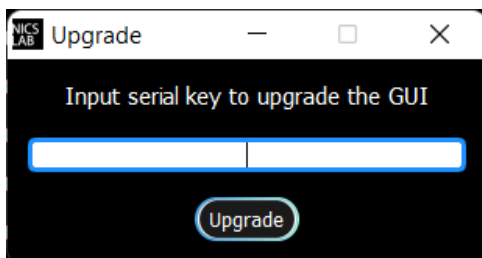

- If your Premium Upgrade Key is valid, you will get a message that indicates a successful upgrade.

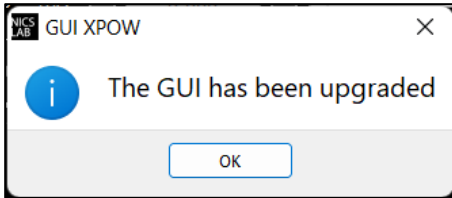

- You can use several features that were previously locked

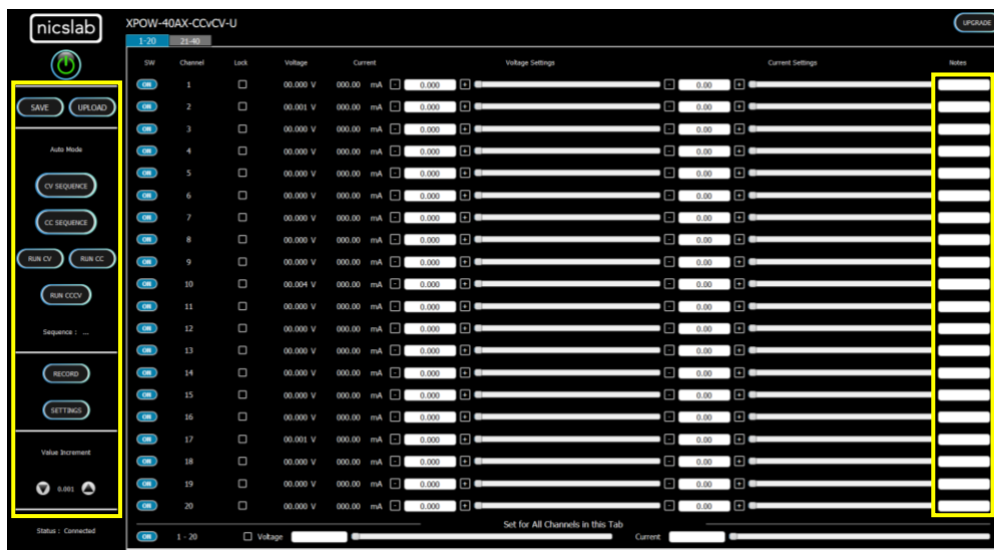
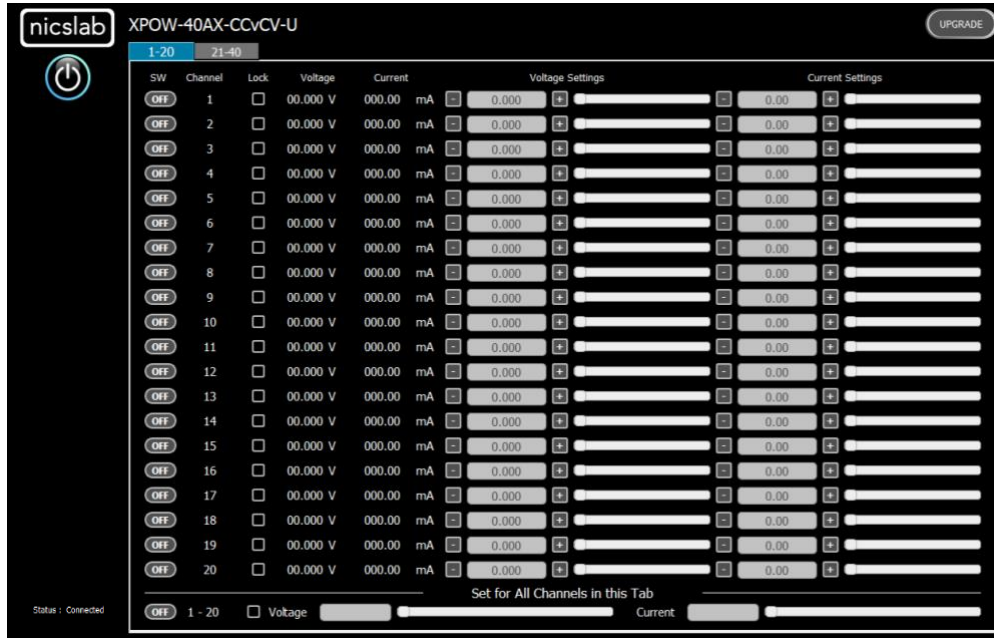

The next few sections are the advanced features that are enabled after upgrading the GUI

Constant Current (CC) Mode

This section shows how to do CC mode according to your purpose:

To do CC mode, you need to move the voltage slider (B23) or adjust the voltage value (B24) to the maximum value before setting the current value on (B22) or slider (B21). As an example, channel 1 was given a 120 Ω load.

Important note: When you input manually the values, always press 'Enter'.

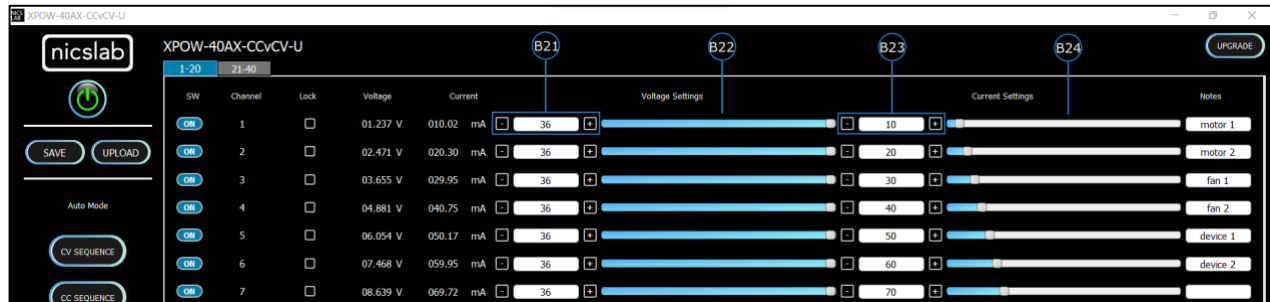

Constant Voltage (CV) Mode

This section shows how to do CV mode according to your aim:

To do CV mode, you need to move the current slider (B21) or adjust the current value (B22) to a certain value. Then adjust the voltage value (B24) or slider (B23). As an example, channel 1 was given a 120 Ω load.

Important note: When you input manually the values, always press 'Enter'.

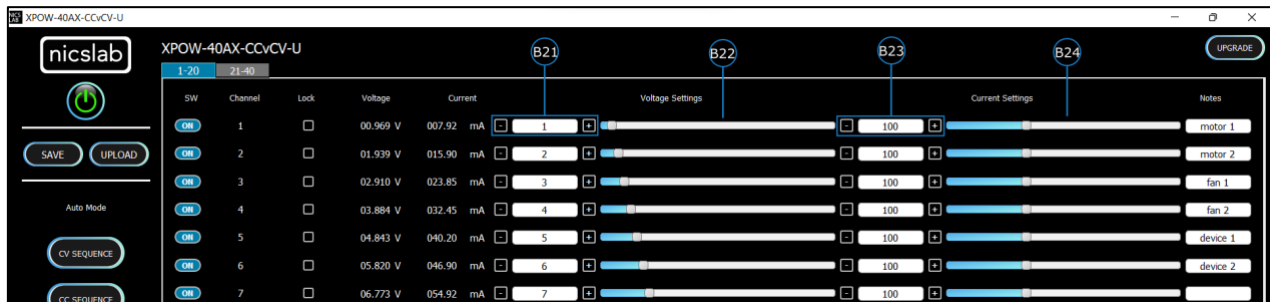

Save and Upload

The CSV file (.csv) resulting from the Save function can be uploaded again through the Upload button (B3). You may also create your own CSV file of voltage and current to be uploaded later.

1. To save the configuration, click the 'Save' button (B2).

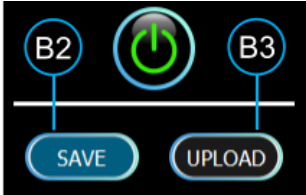

2. Select a directory and write the file name.

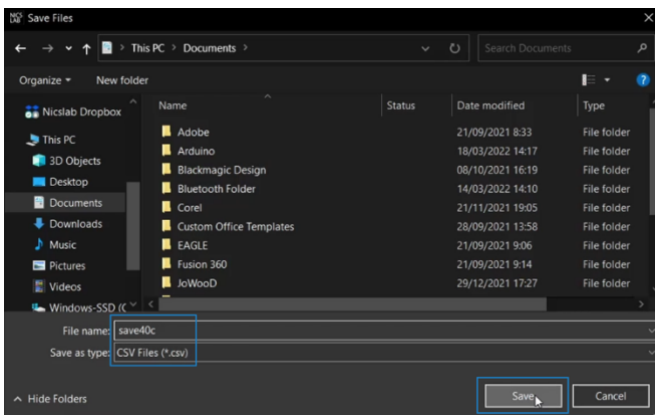

3. The file will be saved as a .csv file.
4. Check the (.csv) file that you have saved.

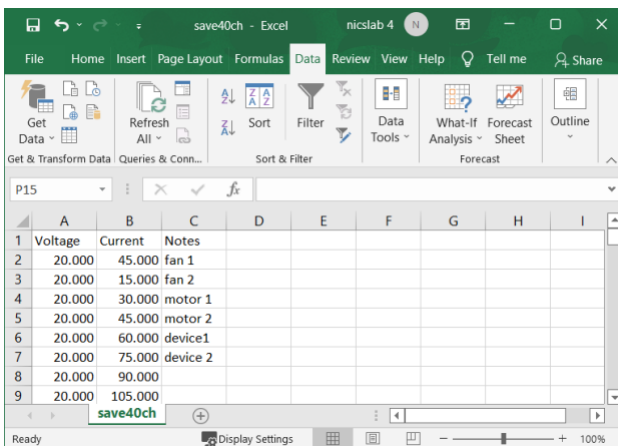
A screenshot of an Excel spreadsheet titled 'save40ch - Excel'. The spreadsheet has three columns: 'Voltage', 'Current', and 'Notes'. The data is as follows:

	A	B	C	D	E	F	G	H	I
1	Voltage	Current	Notes						
2	20.000	45.000	fan 1						
3	20.000	15.000	fan 2						
4	20.000	30.000	motor 1						
5	20.000	45.000	motor 2						
6	20.000	60.000	device1						
7	20.000	75.000	device 2						
8	20.000	90.000							
9	20.000	105.000							

The voltage, current, and notes are recorded.

5. To upload the configuration, click the 'Upload' button (B3).

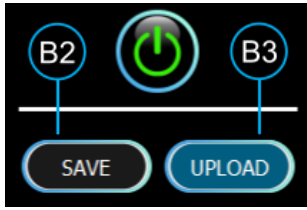

6. Choose and open the intended file

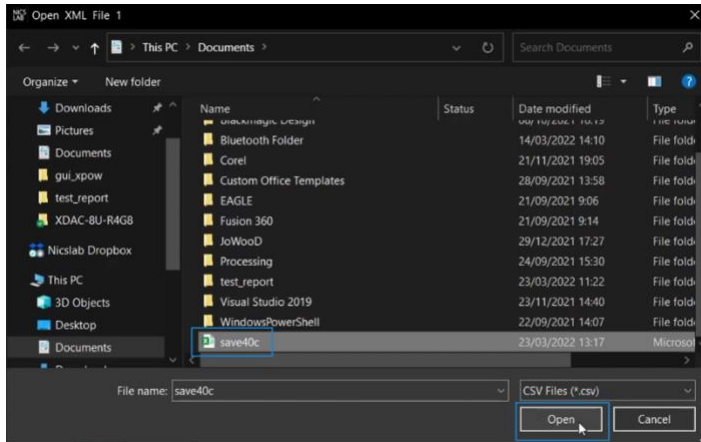

7. It will upload the configuration like the previous configuration.

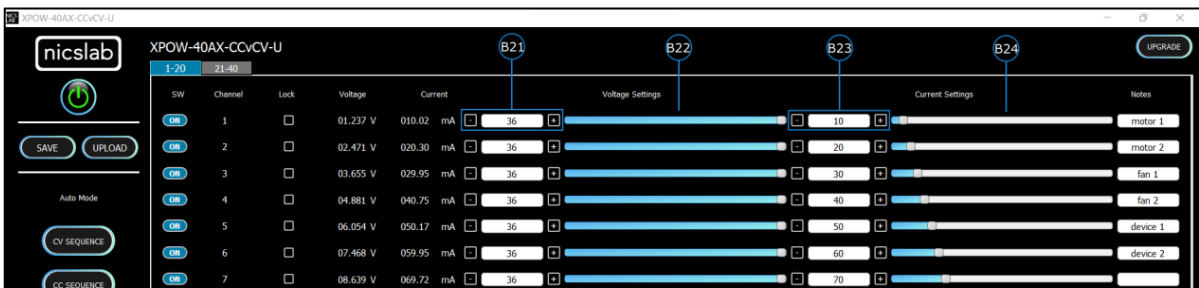

Note: When you upload CV mode, the current setting slider values automatically show 2184.50 bits to open the current flow from the supply. You may adjust this to match your requirements.

Sequence Automation

Sequence is the setting that automates the determined values of current (mA) or voltage (V) given the certain Delay Time (in milliseconds).

- The template of the sequence is given, then you need to input your intended values of CC Sequence (from 0 to 300 mA), CV Sequence (from 0 to 36 V), and Delay Time (in milliseconds). Set the delay time to more than 2 seconds to have more accurate values. To have a faster response (switching time) you can set it via the SCPI command (see Operating XPOW through the SCPI command).

	A	B	C	D	E	F	G	H	I	J
1		Seq 1	Seq 2	Seq 3	Seq 4	Seq 5	Seq 6	Seq 7	Seq 8	Note
2	Delay Time	6000	5478	4912	3409	4213	5902	6012		
3	Channel 1	5	50	0	100	150	150	0	300	Fan1
4	Channel 2	10	50	0	100	160	150	0	300	Fan2
5	Channel 3	15	50	0	100	170	150	0	300	Motor1
6	Channel 4	20	50	0	100	180	150	0	300	Motor2
7	Channel 5	25	50	0	100	190	150	0	300	Sensor1
8	Channel 6	30	50	0	100	200	150	0	300	Sensor2
9	Channel 7	35	50	0	100	210	150	0	300	Sensor3
10	Channel 8	40	50	0	100	220	150	0	300	Not Used

Note:

- Template given for CC and CV sequences.
 - Input your intended values according to the modes (CC: 0 – 300 mA, CV: 0 – 36 V).
- Choose the sequence mode that you will use, either CV Sequence (B4) or CC sequence (B5). When you click, for example, if you want to use a CC sequence, you need to open the corresponding CSV sequence file.
 - After uploading, choose sequence mode by clicking either 'Run CV' (B6 - Mode for CV sequence), 'Run CC' (B6 - Mode for CC sequence), or 'Run CCCV' (B7 – Mode for both CC and CV sequences).

Important note: when 'Run CCCV' use the same delay time on the template .csv of CC and CV sequence.

Record

'Record' (B9) keeps data on voltage and current values. The record starts by the time you click the Record button and finish when you click again the same button.

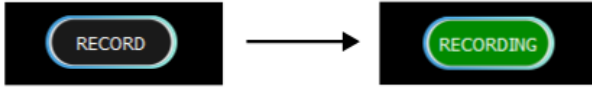

Click the same button to stop recording. After that, put the file in any directory

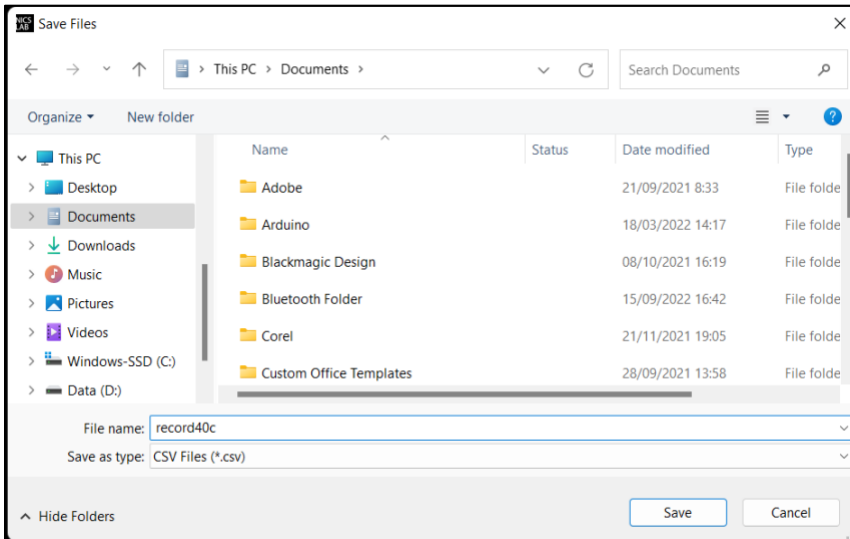

This is the output of the recorded file

The screenshot shows an Excel spreadsheet with the following data:

	A	B	C	D	E	F	G	H	I	J	K	L	M	N	O	P	Q	R
1	Time Stamp	Voltage[1]	Current[1]	Notes	Voltage[2]	Current[2]	Notes	Voltage[3]	Current[3]	Notes	Voltage[4]	Current[4]	Notes	Voltage[5]	Current[5]	Notes	Voltage[6]	Current[6]
2	14:53:29	6.153 V	50.8 mA	Fan1	6.276 V	50.77 mA	Fan2	6.226 V	50.75 mA	Motor1	6.106 V	51.62 mA	Motor2	5.944 V	50.62 mA	Sensor1	6.095 V	50.7 n
3	14:53:30	6.153 V	50.8 mA	Fan1	6.276 V	50.77 mA	Fan2	6.226 V	50.75 mA	Motor1	6.106 V	51.62 mA	Motor2	5.944 V	50.62 mA	Sensor1	6.095 V	50.72
4	14:53:31	6.153 V	50.8 mA	Fan1	6.276 V	50.77 mA	Fan2	6.226 V	50.75 mA	Motor1	6.106 V	51.62 mA	Motor2	5.944 V	50.62 mA	Sensor1	6.095 V	50.7 n
5	14:53:32	6.153 V	50.8 mA	Fan1	6.276 V	50.77 mA	Fan2	6.226 V	50.75 mA	Motor1	6.106 V	51.62 mA	Motor2	5.944 V	50.62 mA	Sensor1	6.095 V	50.7 n
6	14:53:33	2.987 V	24.92 mA	Fan1	6.276 V	50.77 mA	Fan2	6.226 V	50.75 mA	Motor1	6.106 V	51.62 mA	Motor2	5.944 V	50.62 mA	Sensor1	6.095 V	50.7 n
7	14:53:34	0.959 V	7.85 mA	Fan1	2.609 V	21.12 mA	Fan2	6.225 V	50.75 mA	Motor1	6.106 V	51.62 mA	Motor2	5.944 V	50.62 mA	Sensor1	6.095 V	50.7 n
8	14:53:35	0.959 V	7.85 mA	Fan1	1.93 V	15.52 mA	Fan2	2.9 V	23.6 mA	Motor1	3.87 V	32.7 mA	Motor2	5.293 V	45.15 mA	Sensor1	6.095 V	50.7 n
9	14:53:36	0.96 V	7.85 mA	Fan1	1.93 V	15.55 mA	Fan2	2.9 V	23.6 mA	Motor1	3.87 V	32.7 mA	Motor2	4.819 V	41.02 mA	Sensor1	5.818 V	48.42
10	14:53:37	0.959 V	7.85 mA	Fan1	1.93 V	15.55 mA	Fan2	2.9 V	23.6 mA	Motor1	3.87 V	32.7 mA	Motor2	4.819 V	41.02 mA	Sensor1	5.818 V	48.42
11	14:53:38	0.959 V	7.85 mA	Fan1	1.931 V	15.55 mA	Fan2	2.9 V	23.6 mA	Motor1	3.87 V	32.7 mA	Motor2	4.819 V	41.02 mA	Sensor1	5.818 V	48.42
12	14:53:39	0.96 V	7.85 mA	Fan1	1.931 V	15.55 mA	Fan2	2.901 V	23.6 mA	Motor1	3.87 V	32.7 mA	Motor2	4.819 V	41.02 mA	Sensor1	5.818 V	48.42

Setting Voltage and Current Limit

Click the 'Settings' button (B10).



The 'Settings' feature consists of:

- Set the maximum limit for voltage values.
- Set the maximum limit for current values.

The screenshot shows the main interface of the XPOW-40AX-CCvCV-U device. The 'Settings' window is open, displaying the 'Set Limit' tab. The 'Voltage' sub-tab is selected, showing a grid of input fields for setting voltage limits for 20 channels. The values are: 1: 0.9 V, 2: 1.1 V, 3: 2.2 V, 4: 3.3 V, 5: 4.4 V, 6: 5.5 V, 7: 6.6 V, 8: 7.7 V, 9: 8.8 V, 10: 9.9 V, 11: 1 V, 12: 2 V, 13: 3 V, 14: 4 V, 15: 5 V, 16: 6 V, 17: 7 V, 18: 8 V, 19: 9 V, 20: 10 V. A blue arrow points from the 'Set Voltage Limit' text to the 'Voltage' sub-tab.

The screenshot shows the main interface of the XPOW-40AX-CCvCV-U device. The 'Settings' window is open, displaying the 'Set Limit' tab. The 'Current' sub-tab is selected, showing a grid of input fields for setting current limits for 20 channels. The values are: 1: 1 mA, 2: 11 mA, 3: 20 mA, 4: 30 mA, 5: 40 mA, 6: 50 mA, 7: 60 mA, 8: 70 mA, 9: 80 mA, 10: 300 mA, 11: 300 mA, 12: 300 mA, 13: 300 mA, 14: 300 mA, 15: 300 mA, 16: 300 mA, 17: 300 mA, 18: 300 mA, 19: 300 mA, 20: 300 mA. A blue arrow points from the 'Set Current Limit' text to the 'Current' sub-tab.

Important note: When you input the values, always press 'Enter'.

Setting Voltage Range

Set range for voltage values where you can choose the voltage range to limit the voltage values (B23, B24, and B26), the range of voltages are 5 V, 10 V, 20 V, and 36 V. Each range has 16-bit precision.

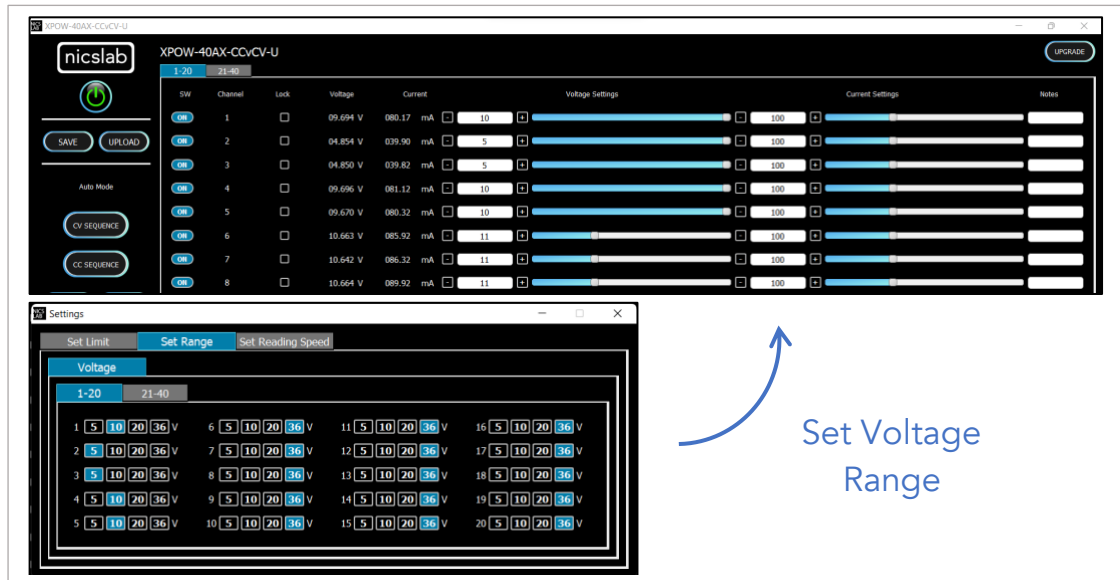

Setting Reading Speed

When setting the reading speed for current and voltage, there are three options: Fast, Medium, and Slow. Faster options can make conversion time smaller but the results noisier.

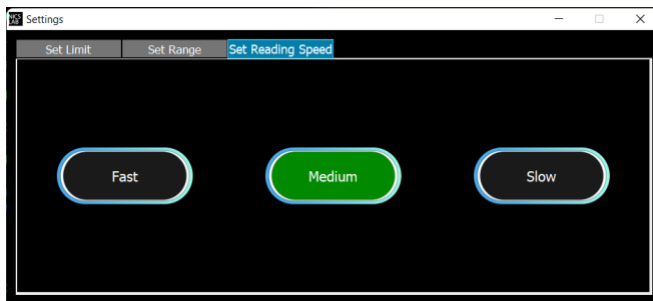

Value Increment Setting

In this setting, the value of the voltage and current can be incrementally changed from 0.001 to 1. Click the arrow to increase and decrease the value increment (B11).

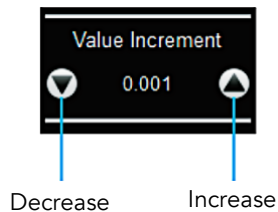

4. Operating XPOW through the SCPI command

This section set guidelines to help you develop a program for any language that suits you best. The example language program is written in Python.

Python Installation (Example)

Please follow the steps below for dynamic programming using SCPI commands through Python via serial.

The following Python versions and packages need to be installed:

1. Python 2.7 or Python 3.X (download and install the latest version from www.python.org). *Tested with Python 3.7.
2. PyCharm 2017.3.4 or the latest version (download and install the latest version from <https://www.jetbrains.com/pycharm/>)

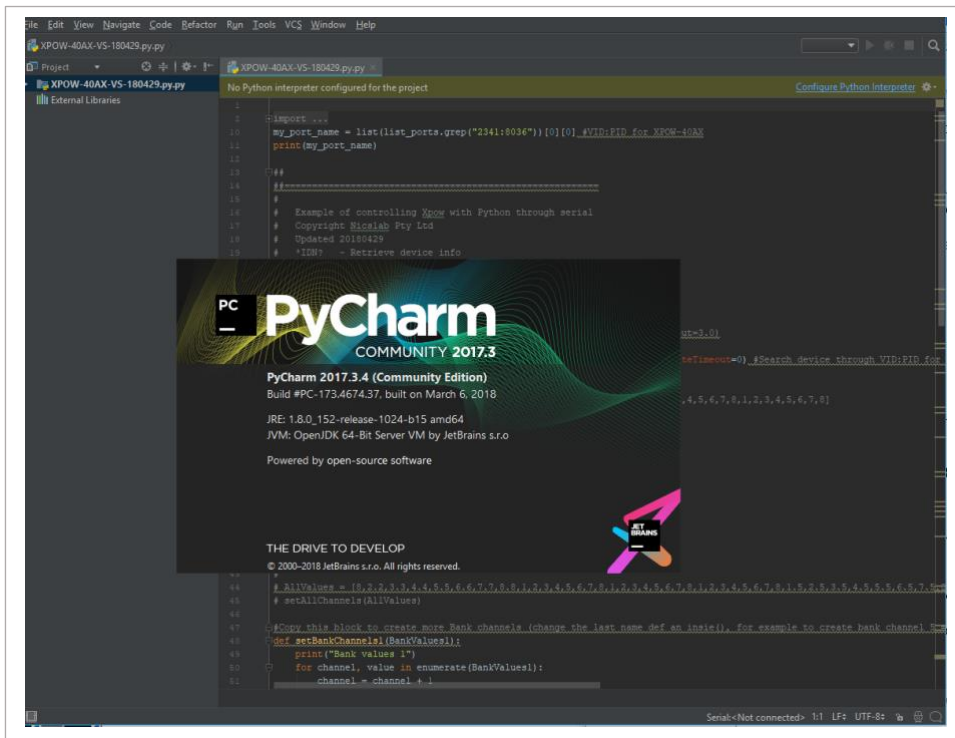

Run Python Code (Example)

To run the Python code please follow the steps below:

1. Open PyCharm software and open file example (e.g XPOW-40AX-CCvCV-U.py)

2. Configure the Python interpreter (see figure below) by clicking Configure Python Interpreter link on the top right-hand corner of the code, or in File → Settings → Project Interpreter in Windows or Preference → Project Interpreter in Mac. Select Python 2.7 or Python 3.X in the Project Interpreter list.

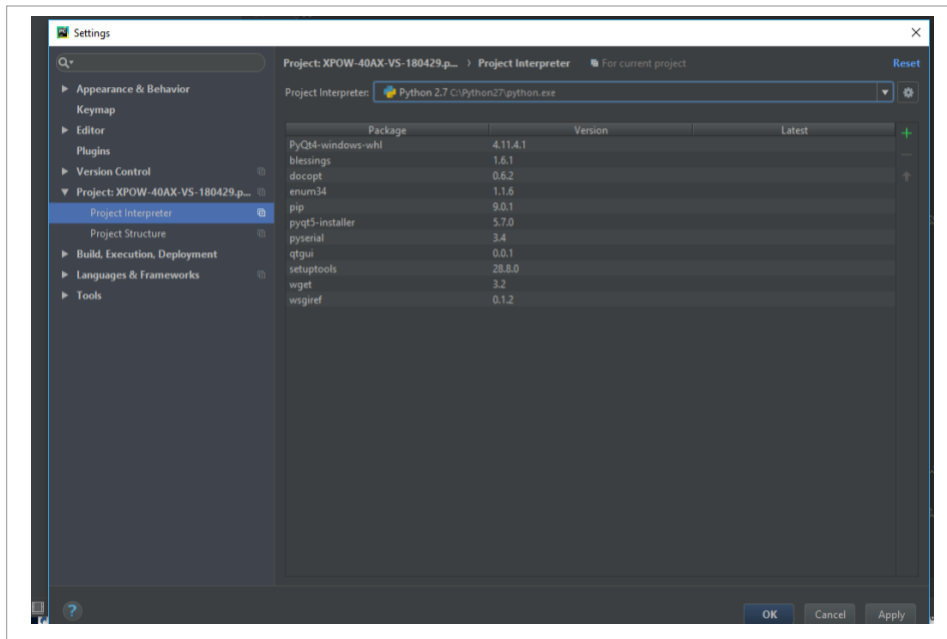

3. Install additional packages: enum34, pip, pyserial, and setup tools by clicking the “+” button, then search and install all the packages.

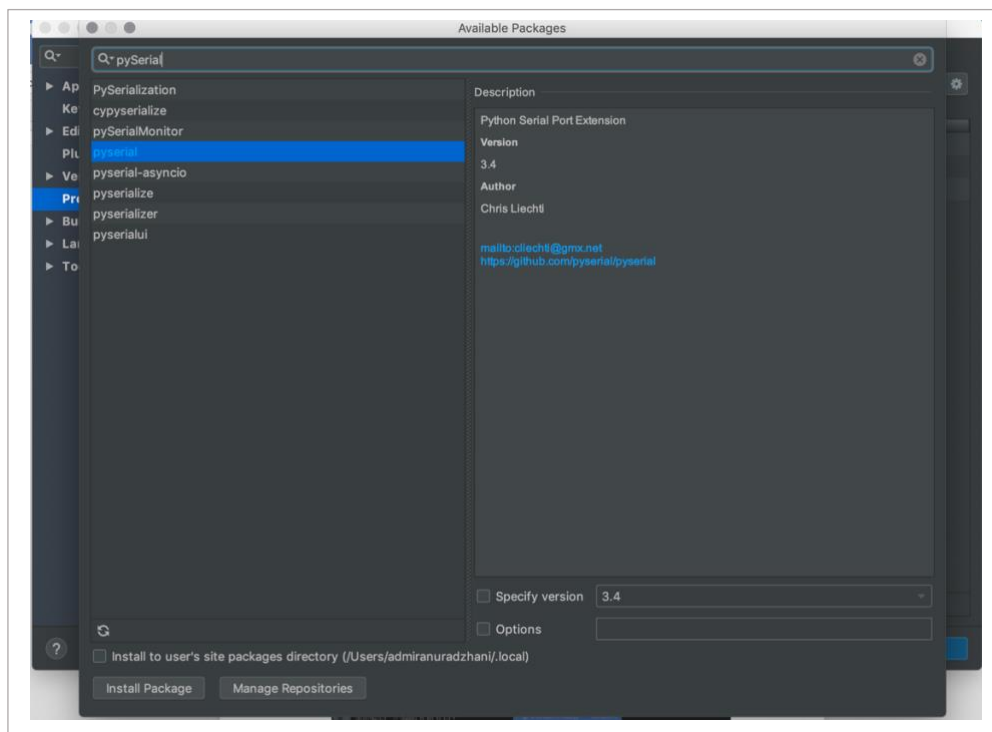

4. Select Python Configuration and choose the file name.

- Run the file by clicking the green arrow button on the top right corner to test the XPOW (Please refer to the code and SCPI commands references)

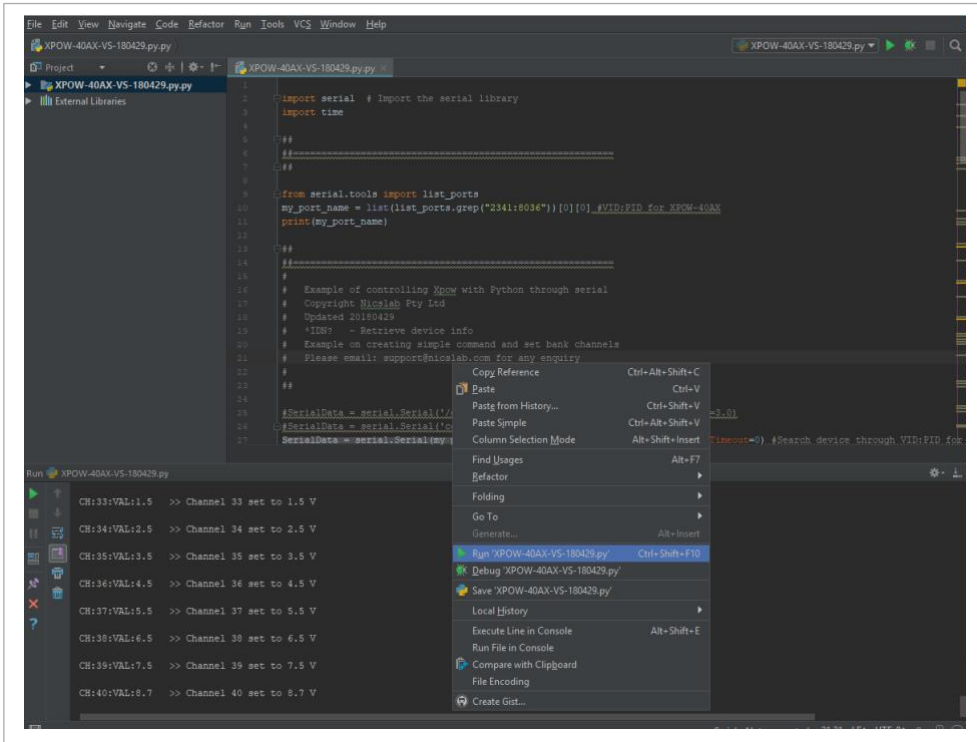

Python Function (Example)

- Constant Voltage Calibration for single channel

Calibration work by applying voltage and current below the limit that we set in this function

```
cvCalibrationSingleChannel(channel, vcal, ccal)
```

channel (int): channel number

vcal (float): 0 - 36 V

ccal (float): 0 - 300 mA

Example:

Calibration with DUT connected to channel 1, volt limit 0.5 V, and current Limit 10 mA.

```
cvCalibrationSingleChannel(1, 0.5, 10)
```

2. Constant Voltage Calibration for all channel

Calibration work by applying voltage and current below the limit that we set in this function

```
cvCalibrationAllChannel(vcal, ccal)
```

```
vcal (float array): 0 - 36 V
```

```
ccal (float array): 0 - 300 mA
```

3. Set ON for single channel

```
setChannel(channel, voltageVal, currentVal)
```

```
channel (int): channel number
```

```
voltageVal (float): 0 - 36 V
```

```
currentVal (float): 0 - 300 mA
```

4. Set ON for all channels

```
setVoltageAllChannels(AllVValues)
```

```
AllVValues (float array): voltage values in array (V)
```

```
setCurrentAllChannels(AllCValues)
```

```
AllCValues (float array): current values in array (mA)
```

Example:

```
AllCValues = [100, 150, 100, 50, 200, 10, 10]
```

```
AllVValues = [20.1, 2.5, 13.0, 4, 5, 10.5, 9.5, 22]
```

5. Set Range for all channels

```
setRangeAllChannels(AllRangeValues)
```

```
AllRangeValues (Int array): voltage range index values in array
```

Array Index:

```
0: 0 - 5 V
```

```
1: 0 - 10 V
```

```
2: 0 - 20 V
```

```
4: 0 - 34 V (with 36 power supply)
```

Example:

```
AllRValues = [1, 0, 1, 0, 2, 1, 0]
```

6. Set GPIO digital output

```
setGPIO(index, value)
```

Index (int): Index of GP pin (12, 13, 16, 19, 26)

Value (string): "HIGH" or "LOW"

Example:

Set GP26 output to digital high

```
setGPIO(26, "HIGH")
```

7. Set Measurement Config

```
measurementConfig(voltConvTime, currConvTime, averaging)
```

voltConvTime (Int uS): Voltage measurement conversion time

currConvTime (Int uS): Current measurement conversion time

averaging (int): count of samples to be averaged

8. Set OFF for single channel

```
setOff(channel)
```

channel (int): channel number

9. Set OFF for all channels

```
setOffAllChannels(maxChannel)
```

maxChannel (int): maximum number of channels in XPOW

10. Read real-time value for single channel

```
readChannel(channel)
```

channel (int): channel number

11. Read real-time value for all channels

```
readCommand(maxChannel)
```

maxChannel (int): maximum number of channels in XPOW

12. Automatic Setting for One Channel

Change and record the value in one channel for every time duration. The result will be saved as a CSV file.

```
sweepOne(channel, seqValueV, seqValueC, duration)
```

channel (int): channel number

seqValueV (float array): values for the voltage (V) for one channel in array.

seqValueC (float array): values for the current (mA) for one channel in array

duration (int): waiting time to change to the next value in seconds

Example:

```
channel = 1
```

```
seqValueV = [20.1, 2.5, 13.0, 4, 5, 10.5, 9.5, 22]
```

```
seqValueC = [100, 150, 100, 50, 200, 10, 10]
```

```
duration = 5
```

SCPI Commands

The XPOW can be controlled using Standard Commands for Programmable Instruments (SCPI) with 115200 baud rates.

Description: Constant Voltage Mode Calibration for single channel

Format:

```
CH:[n]:CALIB:[V Values]:[C Values]
```

Description: Set output voltage for single channel

Format:

```
CH:[n]:VOLT:[VOLT VALUES]
```

Result:

```
<CH:1:VOLT:[VOLT VALUES]:OK>
```

Example 1: Set the output voltage of channel 1 to 36V

```
CH:1:VOLT:34 (set the output voltage of channel 1 to max 36 V)
```

Result:

```
<CH:1:VOLT:34:OK>
```

Example 2: Set the output voltage of channel 3 to 20V

CH:3:VOLT:20 (set the output voltage of channel 3 to 20 V)

Result:

<CH:3:VOLT:20:OK>

Description: Set output current for single channel

Format:

CH:[n]:CUR:[CURRENT VALUES]

Result:

<CH:1:CUR:[CURRENT VALUES]:OK>

Example 1: Set the output current of channel 1 to 300 mA.

CH:1:CUR:300 (set the output current of channel 1 to max 300 mA)

Result:

<CH:1:CUR:300:OK>

Example 2: Set the output current of channel 3 to 150 mA.

CH:3:CUR:150 (set the output current of channel 3 to 150mA)

Result:

<CH:3:CUR:150:OK>

Display real-time data for single channel

Format:

CH:[n]:VAL?

Description: Display voltage and current real-time value of channel n.

Result:

<val:[n]:VOLTAGE VAL:CURRENT VAL>

Example:

CH:1:VAL?

Result:

<val:1:6.101:100.211>

Set output voltage for a group of channels

Format:

CH: [m-n]:VOLT:[0-Vmax]

Description: Set the output voltage of channel m to channel n to [0-36 V].

Note: $1 \leq m < n \leq \text{Channel Max}$

Example:

CH:1-8:VOLT:20 (set outputs of channel 8 to channel 10 to 20 Volt)

Set output current for a group of channels

Format:

CH: [m-n]:CUR:[0-Amax]

Description: Set the output of channel m to channel n to [0-300 mA].

Note: $1 \leq m < n \leq \text{Channel Max}$

Example:

CH:1-8:CUR:150 (set outputs of channel 1 to channel 8 to 150 mA)

Set measurement config

Format:

MEASCONF:VoltConvTime:CurrConvTime:Averaging

Description: Set measurement conversion time in μs and average sample counts.

Result:

MEASCONF:VoltConvTime:CurrConvTime:Averaging >> OK!

Set pin GPIO

Input

Format:

GPIO:[PIN NAME]

Description: Read the GPIO pin

Example:

```
GPIO:PD4
```

Result :

```
GPIO:PD4
```

Output - High

Format:

```
GPIO: [PIN NAME] :HIGH
```

Description: Set the GPIO pin to high (5V)

Example:

```
GPIO:PF5:HIGH
```

Result : GPIO:PF5:HIGH

Output - Low

Format:

```
GPIO: [PIN NAME] :LOW
```

Description: Set the GPIO pin to low (0V)

Example:

```
GPIO:PF5:LOW
```

Result :

```
GPIO:PF5:LOW
```

Retrieve device information

Format:

```
*IDN?
```

Description: Get information about the device.

Example:

```
*IDN?
```

Result :

```
*IDN? >> XPOW-40AX-CCvCV-U, Nicslab Ops, Inc.
```

Set range

Format:

CH: [n] :SVR: [0-3]

Note:

0 -> 5 V

1 -> 10 V

2 -> 20 V

3 -> 36 V

Default: 3

Result:

<CH: [n] :SVR: [RANGE VALUES] :OK>

Example 1: Set the range of channel 1 to maximum.

CH:1:SVR:3 (set the range of channel 1 to max 36 V)

Result:

<CH:1:SVR:3:OK>

5. System Shutdown

This section describes how to shut down the XPOW-40AX-CCvCV-U.

In the case of using GUI, the steps are as follows:

1. Set OFF all the channels in the GUI.
2. Press the ON/OFF Button in GUI (B1, Figure 4). It will change the color of the button from green to grey.
3. Close the GUI application.
4. Press button A1 (Figure 3).
5. Turn off the DC Power Supply.

In the case of using SCPI Command, the steps are as follows:

1. Use `setOff(channel)` function to set off the channel used before.
2. Press button A1 (Figure 3).
3. Turn off the DC Power Supply

NOTE: Once the soft shutdown occurred, the **Green & Blue** led will be turned off. To use XPOW-40AX-CCvCV-U after a soft shutdown, just switch off and switch on again (restart) the XPOW-40AX-CCvCV-U.

6. Troubleshooting

Please use the following guidelines to identify a particular problem. If the solution does not rectify the problem, contact us at support@nicslab.com.

Table 5. Troubleshooting

Problem	Cause	Solution
The front end light is off when the switch is turned on	No USB connection	Check USB connection to Laptop/PC
The Blue light is off when the software is active or the software freezes	Initialization failed	Restart the software, or unplug - plug the USB connector, or Press Reset Button
No channel output detected at the device under test	Connection failed	Check the metal pad checkpoint to the intended channel
No USB port detected at the device manager	No USB connection	Turn on the XPOW-40AX box before running the application, and check the USB connection Check the Arduino Driver if it is installed on the computer. Check to another USB port.
Unable to upload the file	File format problem	Make sure the file format is .csv
No value after uploading the file	File problem	Check the file content and make sure there is no blank space on each row.
Unable to use the Auto Mode feature	File format problem	Check the file format, it should be a CSV file. Check content format
Display value unstable in GUI	Serial Connection Failed	Change the USB cable. Use a low-noise USB cable.

7. Warranty

Nicslab warrants the hardware and software designed by Nicslab to work accordingly, fulfilling the highest standard of quality product. Nicslab is not liable for consequential or incidental damages or errors subject to misuse, neglect, accident, modification, use in critical operation, or has been soldered or altered in any way outside stated by us or unauthorized maintenance.

Nicslab retains to change the material and technical data of this manual at any time without notice, in future editions.

Please do not hesitate to contact us at support@nicslab.com if you would like to have more information on the warranty or return and refund policy.

8. Compliance

This product complies with the requirements of the European Union's *Conformite Europeenne* (CE) and Restriction of Hazardous Substances in Electrical and Electronic Equipment (RoHS) Directive 2015/863 (RoHS3). The certificates can be accessed [here](#).

9. Contact

United States

Nicslab Inc

228 Hamilton Avenue, 3rd Floor, Palo Alto

Silicon Valley, CA, 94301

Phone number: +1 (650) 798-5000

WhatsApp: +1 (650) 613-2494

Email: support@nicslab.com

Website: www.nicslab.com

Indonesia

PT. Nicslab Global Industri

Wisma Monex 9th floor

Jl. Asia Afrika No. 133-132, Bandung, West Java, 40112

Phone: +62 22 8602 6854

Email: nicslab.id@nicslab.com

Book a Meeting [here](#).