

XS508B1CAL08M12

Inductive proximity sensors XS, inductive sensor XS5 M8, L61mm, stainless, Sn1.5 mm, 12...48 VDC, M12 0.8 m



Main

Range of Product	Telemecanique Inductive proximity sensors XS
Series name	General purpose
Sensor Type	Inductive proximity sensor
Device Application	-
Sensor name	XS5
Sensor design	Cylindrical M8
Size	51 mm
Body type	Fixed
Detector flush mounting acceptance	Flush mountable
Material	Stainless steel
Type of output signal	Discrete
Wiring Technique	2-wire
[Sn] nominal sensing distance	0.06 in (1.5 mm)
Discrete output function	1 NO
Output circuit type	DC
Electrical connection	Remote male connector M12, 4 pins
Cable length	2.62 ft (0.8 m)
[Us] rated supply voltage	12...48 V DC
Switching capacity in mA	1.5...100 mA DC overload and short-circuit protection
IP degree of protection	IP67 conforming to IEC 60529

Complementary

Thread type	M8 x 1
Detection face	Frontal
Front material	PPS
Enclosure Material	Stainless steel 303
Operating zone	0.00...0.05 in (0...1.2 mm)
Differential travel	1...15% of Sr
Cable composition	2 x 0.11 mm ²
Wire insulation material	PvR
Status LED	Output state 1 LED yellow)
Supply voltage limits	10...58 V DC
Maximum residual current	0.5 mA open state
Switching frequency	<= 4000 Hz
Maximum voltage drop	<4 V closed)
Maximum delay first up	10 ms
Maximum delay response	0.2 ms
Maximum delay recovery	0.2 ms
Marking	CE
Threaded length	1.65 in (42 mm)
Length	2.01 in (51 mm)
Net Weight	0.11 lb(US) (0.05 kg)

Environment

Product Certifications	CCC CSA UL
Ambient Air Temperature for Operation	-13...158 °F (-25...70 °C)
Ambient Air Temperature for Storage	-40...185 °F (-40...85 °C)
Vibration resistance	25 gn +/- 2 mm 10...55 Hz)IEC 60068-2-6
Shock resistance	50 gn 11 ms IEC 60068-2-27

Ordering and shipping details

Category	22490-SENSORS-ULTRASONIC (XX5,6)
Discount Schedule	DS2
GTIN	3389110405194
Nbr. of units in pkg.	1
Package weight(Lbs)	1.34 oz (38.0 g)
Returnability	No
Country of origin	FR

Packing Units

Unit Type of Package 1	PCE
Package 1 Height	0.83 in (2.1 cm)
Package 1 width	4.06 in (10.3 cm)
Package 1 Length	6.14 in (15.6 cm)
Unit Type of Package 2	S02
Number of Units in Package 2	22
Package 2 Weight	3.59 lb(US) (1.629 kg)
Package 2 Height	5.91 in (15 cm)
Package 2 width	11.81 in (30 cm)
Package 2 Length	15.75 in (40 cm)
Package 3 Height	5.91 in (15 cm)

Offer Sustainability

Sustainable offer status	Green Premium product
California proposition 65	WARNING: This product can expose you to chemicals including: Diisononyl phthalate (DINP), which is known to the State of California to cause cancer, and Di-isodecyl phthalate (DIDP), which is known to the State of California to cause birth defects or other reproductive harm. For more information go to www.P65Warnings.ca.gov
REACH Regulation	REACH Declaration
EU RoHS Directive	Pro-active compliance (Product out of EU RoHS legal scope) EU RoHS Declaration
Mercury free	Yes
RoHS exemption information	Yes
Environmental Disclosure	Product Environmental Profile
Circularity Profile	End Of Life Information

Contractual warranty

Warranty	18 months
----------	-----------

Dimensions

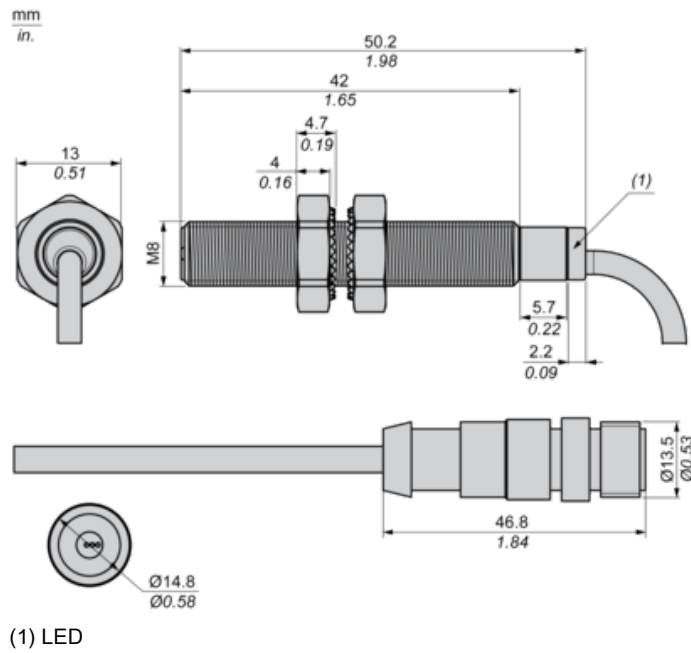

Minimum Mounting Distances

Side by side

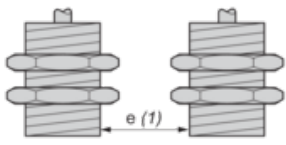

$e (1) \geq 3 \text{ mm}/0.12 \text{ in.}$

Face to face

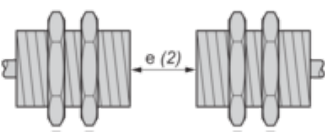

$e (2) \geq 18 \text{ mm}/0.71 \text{ in.}$

Facing a metal object

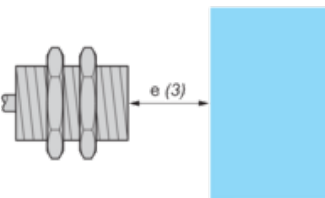

$e (3) \geq 4.5 \text{ mm}/0.18 \text{ in.}$

Wiring Schemes

2-Wire Non-polarised

M12 connector

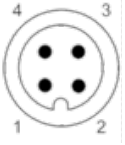

NO output

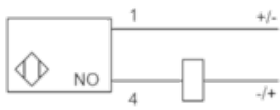

Performance Curves

Standard Steel Target : 8x8x1 mm

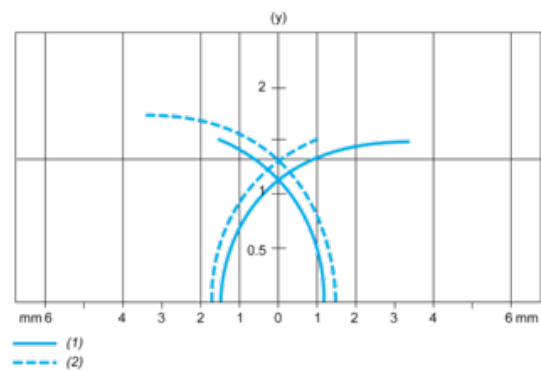

(1) Pick-up points

(2) Drop-out points (object approaching from the side)

(y) Sensing distance in mm