

0RQB-C5W54L

Isolated DC-DC Converter

The 0RQB-C5W54L is an isolated DC/DC converter that provides up to 162 W of output power from a wide input range (72 V, 96 V and 110 V typical).

The unit is designed to be highly efficient. Standard features include remote on/off, input under-voltage lockout, over current protection, short circuit protection and over voltage protection.

Conformal coated PCB is used for environmental ruggedness.

Key Features & Benefits

- 72 / 96 / 110 VDC Input,
- 54 VDC @ 3 A Output
- 1/4th Brick Converter,
- Reinforced Isolation
- Fixed Frequency
- High Efficiency
- Conformal Coated
- Input Under-Voltage Lockout
- Input Over-Voltage Lockout
- Output Over-Voltage Protection
- Over Current and Short Circuit Protection
- Over Temperature Protection
- Approved to EN 62368-1
- Class II, Category 2, Isolated DC/DC Converter (refer to IPC-9592B)

Applications

- Industrial
- Railways
- Telecommunications



bel POWER
SOLUTIONS &
PROTECTION

a bel group

belfuse.com/power-solutions

1. MODEL SELECTION

MODEL NUMBER	OUTPUT VOLTAGE	INPUT VOLTAGE	MAX. OUTPUT CURRENT	MAX. OUTPUT POWER	TYPICAL EFFICIENCY
0RQB-C5W54LG	54 VDC	72 / 96 / 110 VDC	3 A	162 W	91%

PART NUMBER EXPLANATION

0	R	QB	-	C5	W	54	L	G
Mounting Type	RoHS Status	Series Name		Output Power	Input Range	Output Voltage	Active Logic	Package Type
Through Hole Mount	RoHS	Quarter Brick		162 W	72 / 96 / 110 VDC	54 V	Active Low, With Baseplate	Tray Package

2. ABSOLUTE MAXIMUM RATINGS

PARAMETER	DESCRIPTION	MIN	TYP	MAX	UNITS
Continuous non-operating Input Voltage		-0.5	-	160	V
Remote On/Off		-0.3	-	25	V
Trim		0	-	5	V
Thermal resistance	Baseplate to heatsink, flat greased surface	-	0.23	-	°C/W
Current Sink		0	-	10	mA
Isolation Voltage	Input to output	-	-	2250	V
Operating Temperature	Temperature measured at the center of the baseplate, full load	-40	-	90	°C
	Temperature measured at the center of the baseplate, half load	-40	-	95	
Storage Temperature		-55	-	125	°C
Altitude		-	-	2000	m

NOTE: Ratings used beyond the maximum ratings may cause a reliability degradation of the converter or may permanently damage the device.

3. INPUT SPECIFICATIONS

All specifications are typical at 25°C unless otherwise stated.

PARAMETER	DESCRIPTION	MIN	TYP	MAX	UNIT
Operating Input Voltage		43	-	154	V
Input Current (full load)		-	-	5.0	A
Input Current (no load)	V _{in} = 90 V, T _a = 25 °C	-	100	150	mA
Input Reflected Ripple Current (rms)		-	-	15	mA
Input Reflected Ripple Current (pk-pk)		-	-	40	mA
Under-voltage Turn on Threshold	Lockout turn on	39	40	41.5	V
Under-voltage Turn off Threshold	Lockout turn off, non-latching	38.5	39	41	V
Over-voltage Shutdown Threshold	Auto-recovery and non-latching	159	162	164	V
Over-voltage Recovery Threshold		154	155	156	V

4. OUTPUT SPECIFICATIONS

All specifications are typical at nominal input, full load at 25°C unless otherwise stated.

PARAMETER	DESCRIPTION	MIN	TYP	MAX	UNIT
Output Voltage Set Point	Test condition of the output set point: Vin = 72 V, Io = 100% load at 25 °C ambient	53	54	55	V
Load Regulation		-	50	100	mV
Line Regulation		-	50	100	mV
Regulation Over Temperature		-	±200	±350	mV
Output Ripple and Noise (pk-pk)	40 kHz – 100 MHz BW, with 0.1 µF ceramic capacitor and 1000 µF bulk electrolytic at output	-	-	300	mV
Output Ripple and Noise (rms)		-	-	100	mV
Output Current Range		0	-	3	A
Output DC Current Limit	Enter a hiccup mode, non-latching	3.3	3.7	4.2	A
Rise Time	Vin = 72 V, Io = 3 A, with 1000 µF bulk electrolytic at output	-	0.5	1	s
Start-up Time		-	-	2	s
Overshoot at Turn on		-	0	3	%
Undershoot at Turn off		-	0	3	%
Output Capacitance		200	-	1000	µF
Transient Response					
50% load to 75% Load		-	-	2	%Vout
Settling Time	di/dt = 0.1 A/us, with 1000 µF bulk electrolytic at output	-	-	6	ms
75% load to 50% Load		-	-	2	%Vout
Settling Time		-	-	6	ms

5. GENERAL SPECIFICATIONS

PARAMETER	DESCRIPTION	MIN	TYP	MAX	UNIT
Efficiency	Io = 60% – 100% Irate	88	90	-	%
	Io = 40% - 60% Irate	85	88	-	%
Switching Frequency		-	250	-	kHz
Output Voltage Trim Range		50	-	56	V
Over Temperature Protection	Temperature measured at the center of the baseplate	-	120	-	°C
Over Voltage Protection(Static)	Enter a latching, non-hiccup mode	57.5	58	58.5	V
Weight		-	72	-	g
FIT	Calculated Per IEC 62380 TR 1 (UTEK 80-810) (Vin = 72 V, Vo = 54 V, Io = 2.4 A, Tac = 50 °C, Tae = 35 °C)	-	195.08	-	-
MTBF		-	5.13	-	Mhrs
Dimensions (L x W x H)			2.45 x 1.45x 0.59		inch
			62.24 x 36.83 x15.0		mm
Isolation Characteristics					
Input to Output		-	-	2250	Vdc
Input to Heatsink		-	-	2250	Vdc
Output to Heatsink		-	-	2250	Vdc
Isolation Resistance		10M	-	-	Ohm
Isolation Capacitance		-	-	2200	pF



Asia-Pacific
+86 755 298 85888

Europe, Middle East
+353 61 225 977

North America
+1 408 785 5200

6. EFFICIENCY DATA

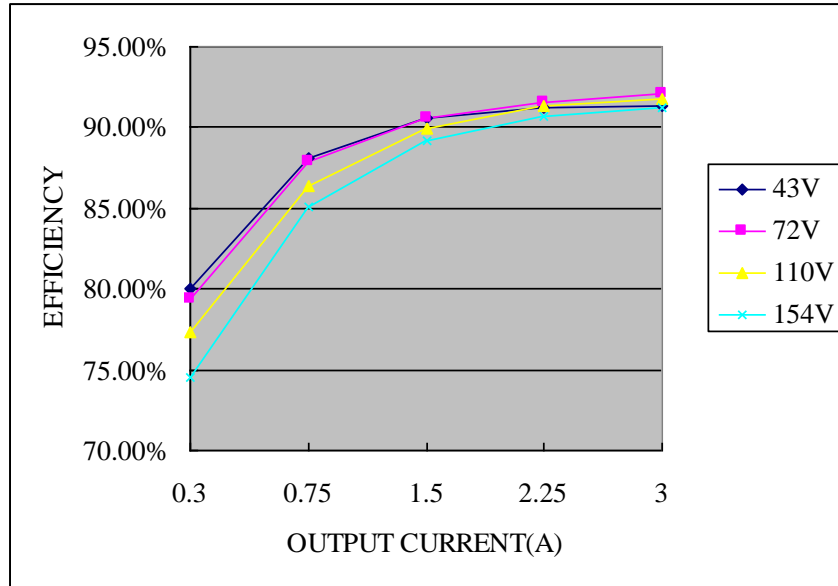

Figure 1. Efficiency data

7. REMOTE ON/OFF

PARAMETER	DESCRIPTION	MIN	TYP	MAX	UNIT
Signal Low (Unit On)	Active Low	-0.3	-	0.8	V
Signal High (Unit Off)		2.4	-	15	V
Current Sink		0	-	1	mA

Recommended remote on/off circuit for active low

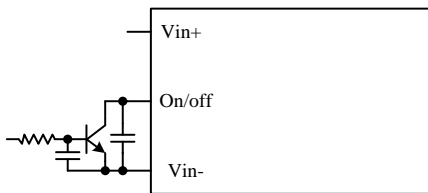

Figure 2. Control with open collector/drain circuit

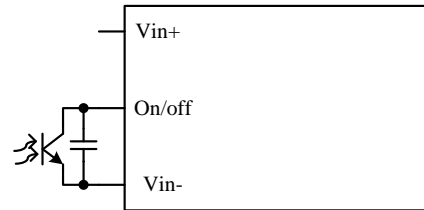

Figure 3. Control with photocoupler circuit

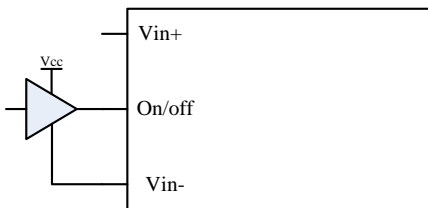

Figure 4. Control with logic circuit

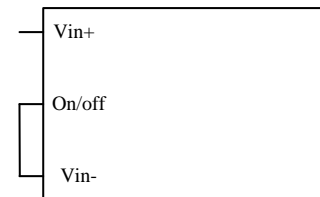

Figure 5. Permanently on

8. REMOTE SENSE

This module has remote sense compensation feature. It can minimize the effects of resistance between output and load in system layout and facilitate accurate voltage regulation at load terminals or other selected point.

1. The remote sense lines carry very little current and hence do not require a large cross-sectional area.
2. This module compensates for a maximum drop of 4% of the nominal output voltage.
3. If the unit is already trimmed up, the available remote sense compensation range should be correspondingly reduced. The total voltage increased by trim and remote sense should not exceed 4% of the nominal output voltage.
4. When using remote sense compensation, all the resistance, parasitic inductance and capacitance of the system are incorporated within the feedback loop of this module which can make an effect on the module's compensation, affecting the stability and dynamic response. A 0.1uF ceramic capacitor can be connected at the point of load to de-couple noise on the sense wires.
5. Recommend the connection of remote sense compensation as below figure. There are a resistor RS+ (100 ohm) from Vo+ to Sense+ and a resistor RS- (100 ohm) from Vo- to Sense- inside of this module.

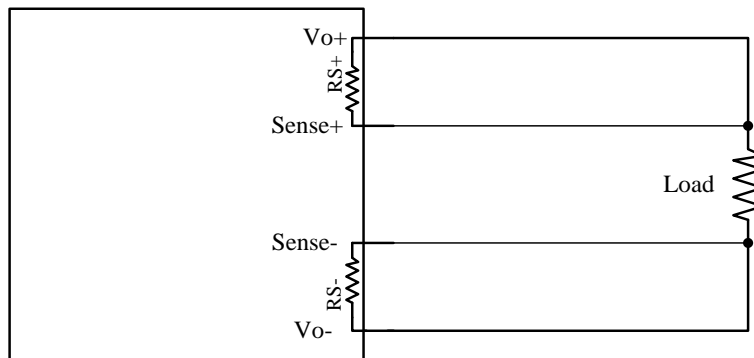

Figure 6.

6. If not using remote sense compensation, please connect sense directly to output at module's pin, that is, connect sense+ to Vo+ and sense- to Vo- at module's pin, the shorter the better. see below figure.

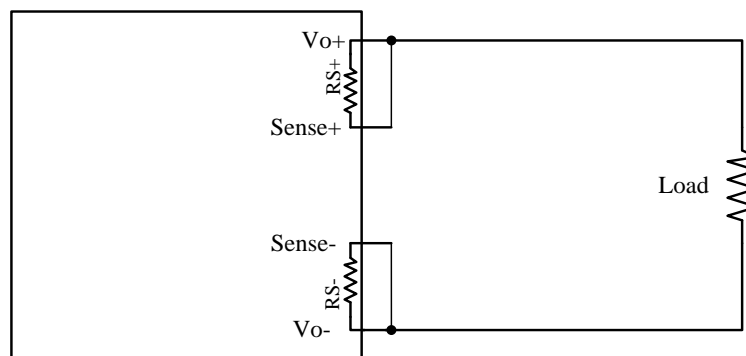

Figure 7.

9. RIPPLE AND NOISE

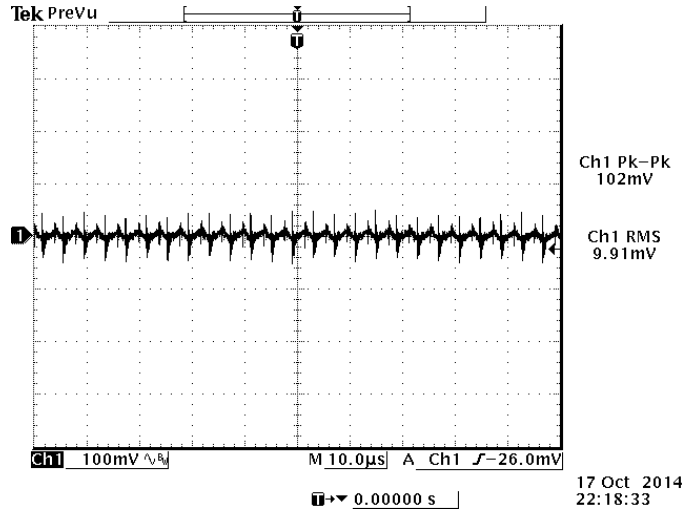

Figure 8. Ripple and noise 72 Vdc input, 54 Vdc/3 A output
 $T_a=25^\circ\text{C}$, and with a 0.1 μF ceramic cap and 220 μF electrolytic cap at output

10. TRANSIENT RESPONSE

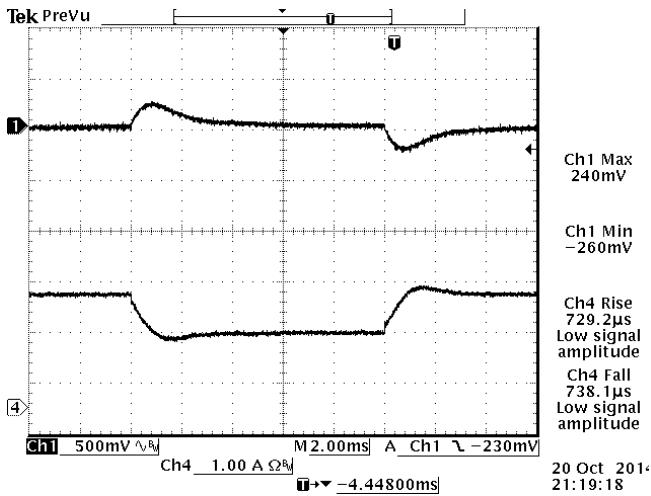

Figure 9. $V_{out} = 54\text{ V}$, 50%-75% Load Transients
at $V_{in} = 72\text{ V}$, $T_a=25^\circ\text{C}$

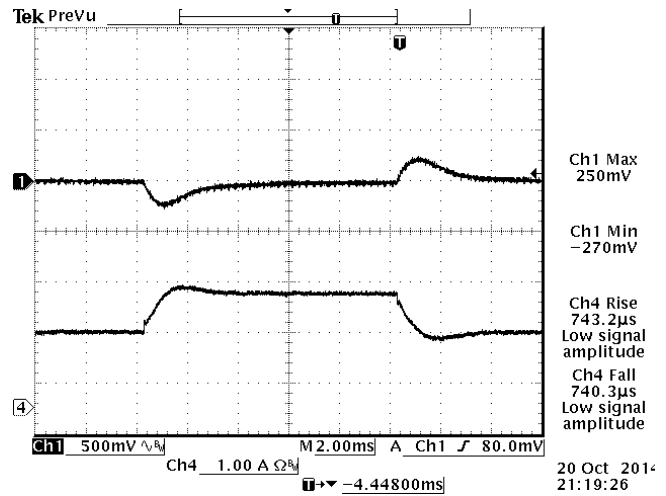

Figure 10. $V_{out} = 54\text{ V}$, 75%-50% Load Transients
at $V_{in} = 72\text{ V}$, $T_a=25^\circ\text{C}$

Note: Transient Response: $di/dt=0.1\text{ A}/\mu\text{s}$, 0.1 μF ceramic cap and 1220 μF electrolytic cap at output.

11. OVER CURRENT PROTECTION

To provide protection in a fault output overload condition, the module is equipped with internal current-limiting circuitry which can endure current limiting for a few milliseconds. If the over current condition persists beyond a few milliseconds, the module will shut down into hiccup mode and restart once every 1600 ms. The module operates normally when the output current goes into specified range. The typical average output current is 0.3 A during hiccup.

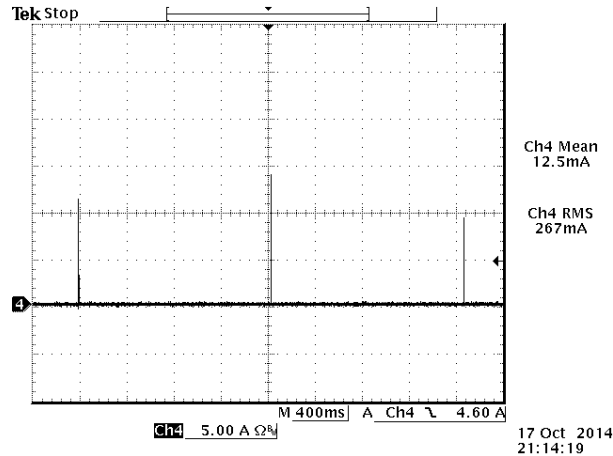

Figure 11. Over current protection

12. INPUT UNDER VOLTAGE LOCKOUT

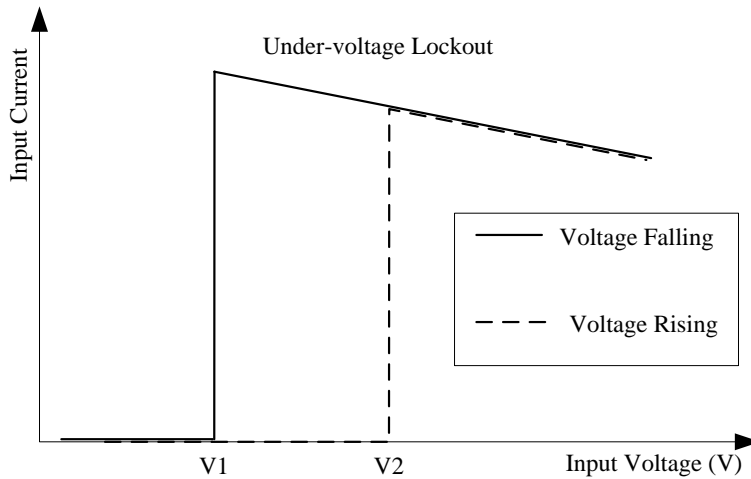

Figure 12. Input under voltage lockout

V1 = 39V

V2 = 40V

13. STARTUP & SHUTDOWN

Startup

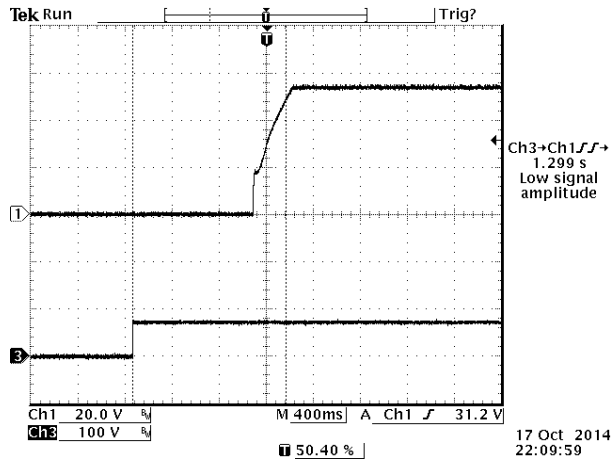

Figure 13.

Shutdown

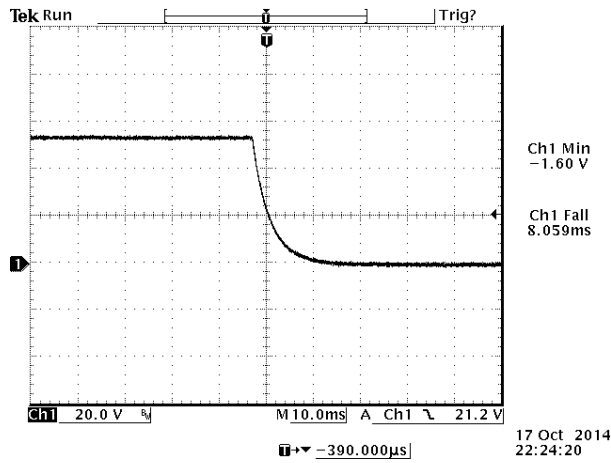

Figure 14.

14. TRIM

ORQB-C5W54L Trim Resistor Calculate

Trim down test circuit:

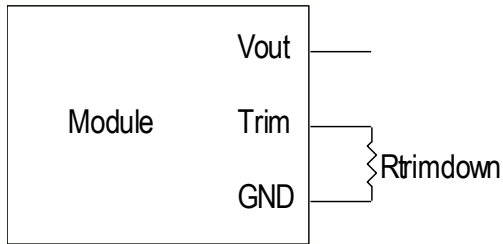

Figure 15. Trim down test circuit

$$R_{trimdown} = \frac{V_{o_req}}{54 - V_{o_req}} - 1 [k\Omega]$$

Trim up test circuit:

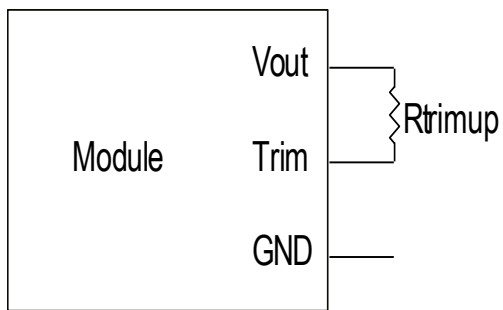

Figure 16. Trim up test circuit

$$R_{trimup} = \frac{1 - 0.02296}{0.02296 - 1.24 / V_{o_req}} - 1 [k\Omega]$$

Note: Vo_req=Desired(trimmed) output voltage[V].

15. THERMAL DERATING CURVE

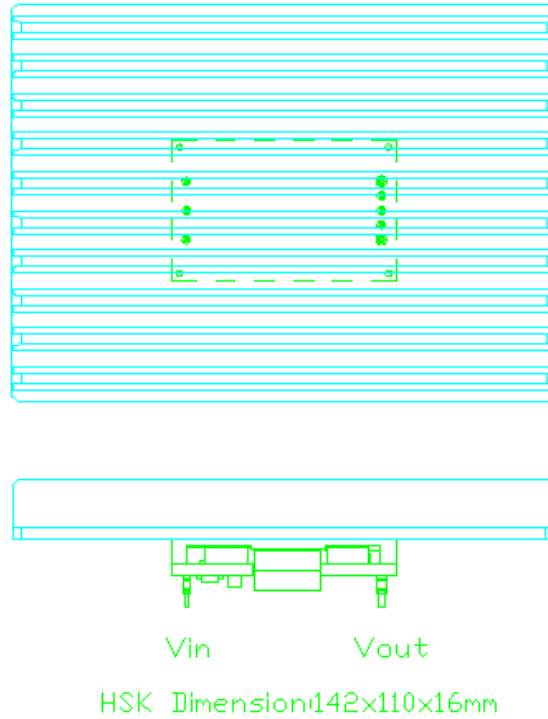

Figure 17. Thermal test setup

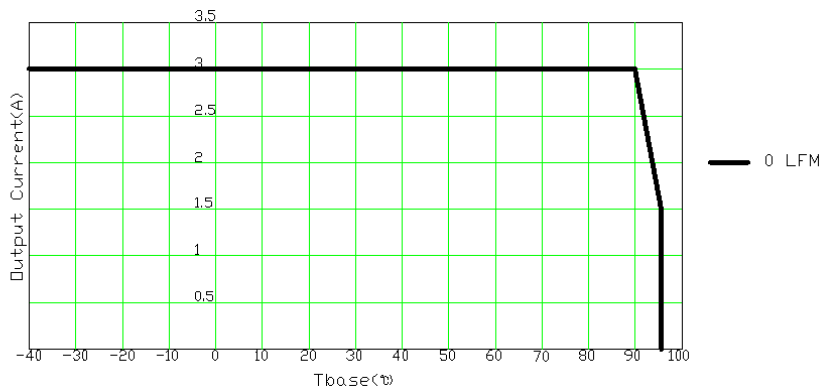

Figure 18. Thermal derating curve

16. SAFETY & EMC

Safety:

Safety approved to EN 62368-1

CE certificated to Low Voltage Directive 2014/35/EU

EMC:

Compliance to EN55032 class A (both peak and average) with the following inductive and capacitive filter.

Test Setup:

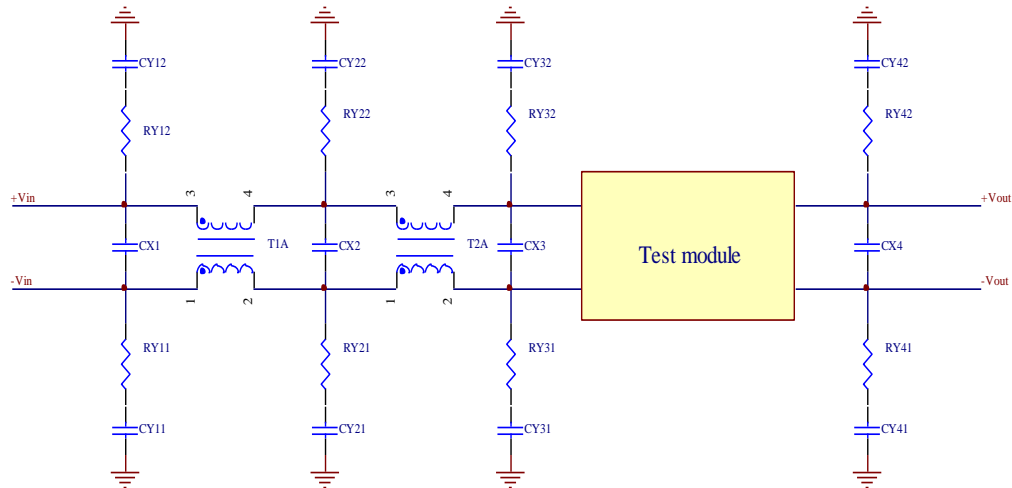

Figure 19.

T1A	CX1	RY11	RY12	CY11	CY12
0.45mH	100uF AL	-	-	-	-
T2A	CX2	RY21	RY22	CY21	CY22
0.9mH	220uF AL	0R	0R	0.22uF	0.22uF
-	CX3	RY31	RY32	CY31	CY32
-	220uF AL	-	-	-	-
-	CX4	RY41	RY42	CY41	CY42

Positive:

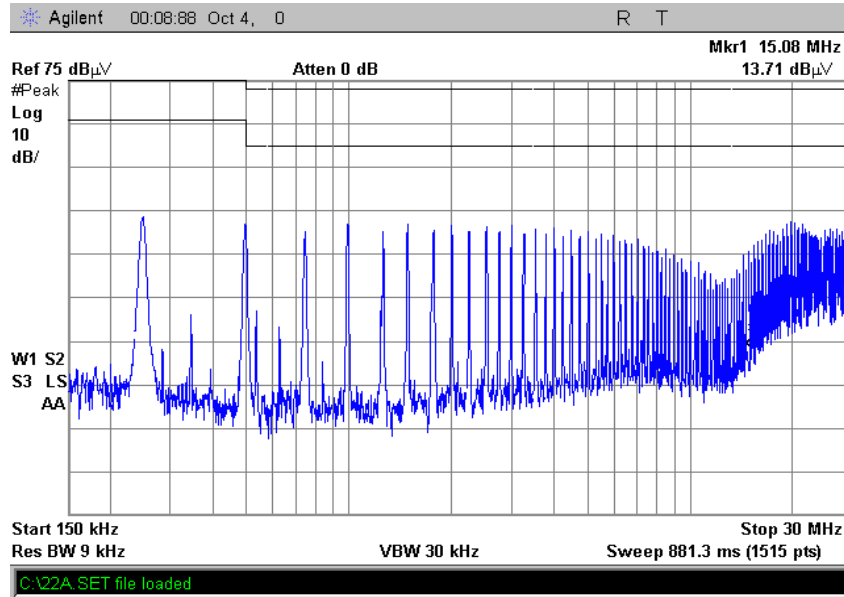

Figure 20.

Negative:

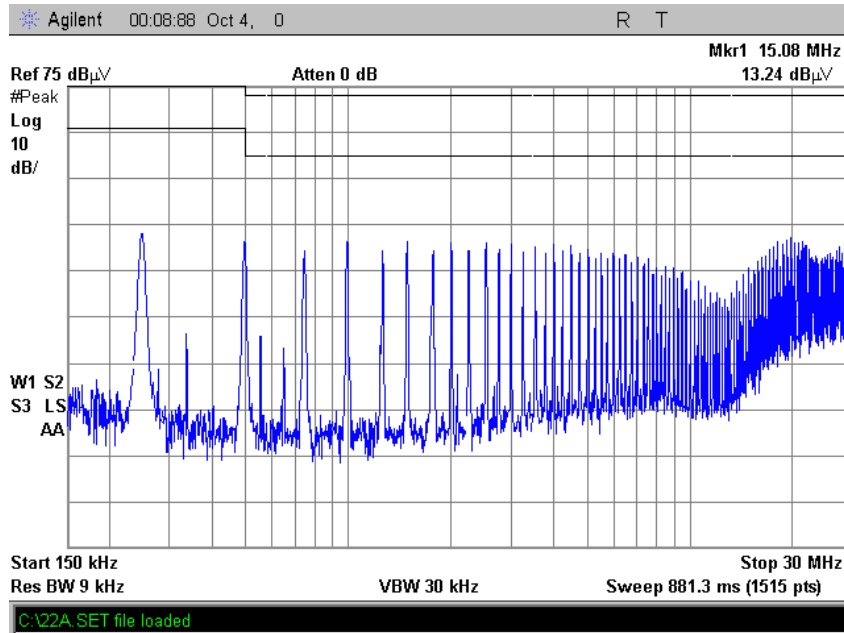

Figure 21.

17. MECHANICAL DIMENSIONS

OUTLINE

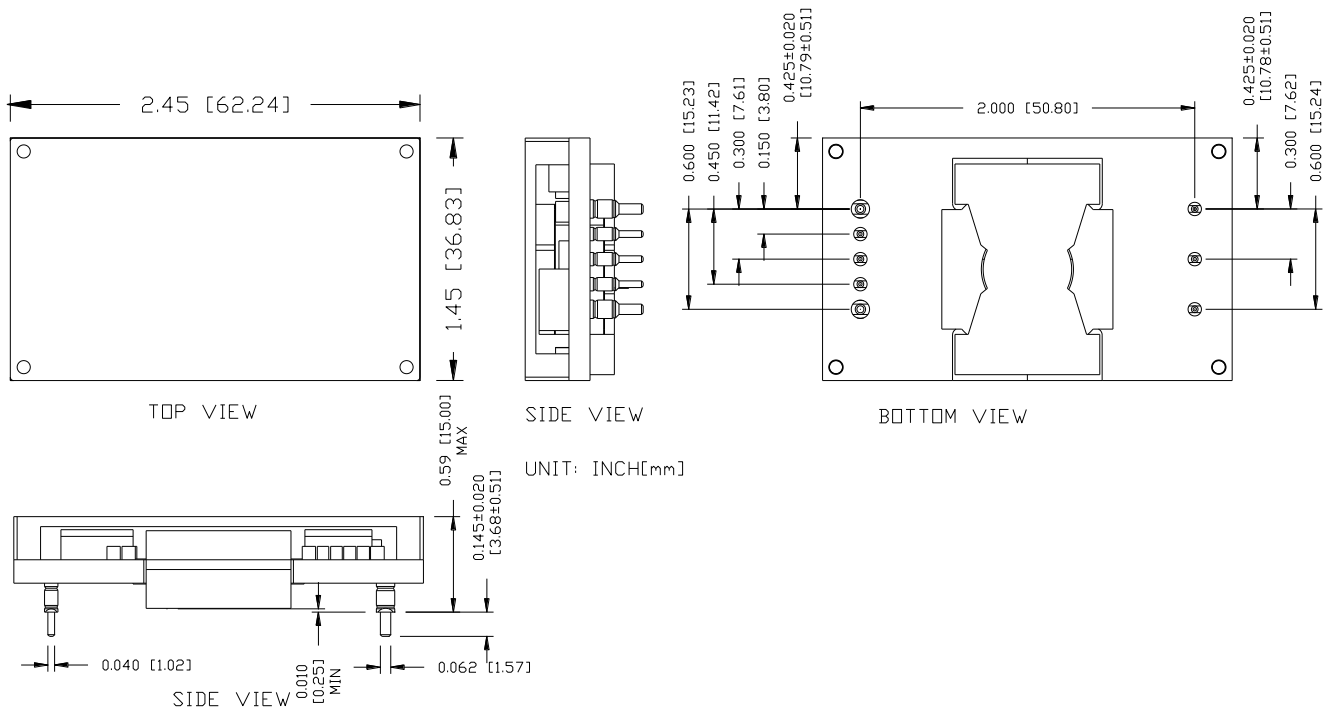

Figure 22. Outline

Note: This module is recommended and compatible with Pb-Free Wave Soldering and must be soldered using a peak solder temperature of no more than 260 °C for less than 5 seconds.

NOTES:

- 1) All Pins: Material - Copper Alloy;
Finish - Tin plated.
- 2) Un-dimensioned components are shown for visual reference only.
- 3) All dimensions in inch [mm]; Tolerances: x.xx +/-0.02 inch [0.51 mm]. x.xxx +/-0.010 inch [0.25 mm].

PIN DEFINITIONS

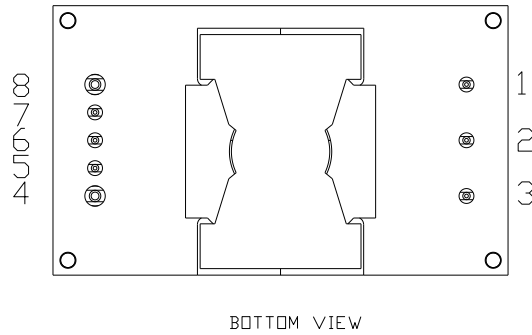
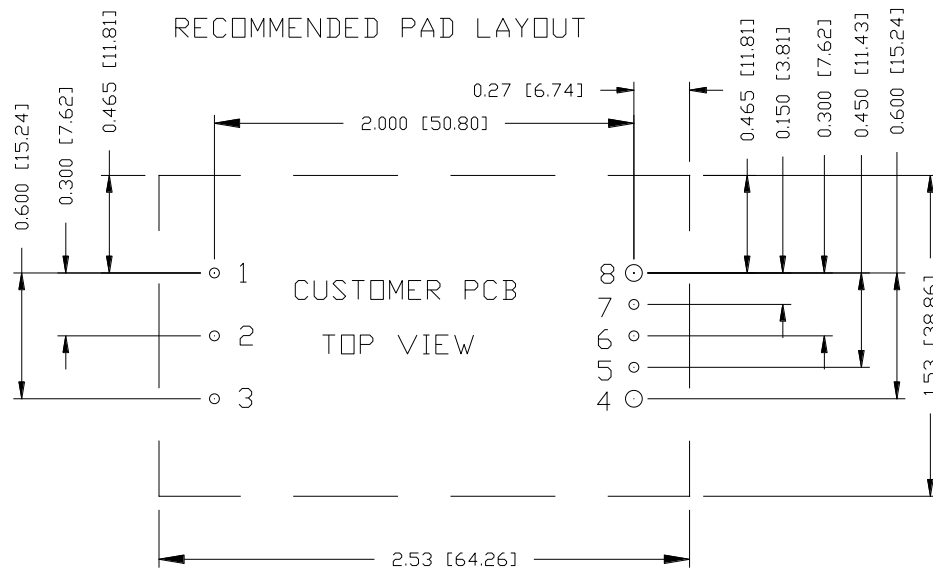

Figure 23. Pins

PIN	FUNCTION	PIN	FUNCTION
1	Vin (+)	5	Sense(-)
2	On/off	6	Trim
3	Vin (-)	7	Sense(+)
4	Vout(-)	8	Vout(+)

RECOMMENDED PAD LAYOUT



1,2,3,5,6,7 \varnothing 0.050 HOLE SIZE, \varnothing 0.100 min PAD SIZE
 4,8 \varnothing 0.074 HOLE SIZE, \varnothing 0.120 min PAD SIZE

Figure 24. Recommended pad layout

18. REVISION HISTORY

DATE	REVISION	CHANGES DETAIL	APPROVAL
2014-10-28	A	First release	S.Wang
2014-12-30	B	Applications update	S.Wang
2015-12-21	C	Update Under-voltage Turn on/off Threshold and Over-voltage Shutdown Threshold in Input Specs. Update Transient Response Settling Time and Over Voltage Protection (Static).	S.Wang
2016-02-26	D	1. Change the Operation temperature in Absolute Maximum Ratings 2. Add Thermal resistance in Absolute Maximum Ratings 3. Remove 48V as the standard input voltage	S.Wang
2016-04-21	E	Update Safety Certification, MTBF, Thermal Derating Curve.	S.Wang
2016-05-18	F	Update Operating Temperature, Transient Response	S.Wang
2017-09-26	AG	Update the form.	S.Wang
2018-06-25	AH	Update Input Spec	S.Wang
2019-08-26	AI	Update the safety info.	S.Wang
2019-10-24	AJ	Add feature reinforced isolation	S.Wang
2021-05-18	AK	Add object ID. Update outline and recommended pad layout.	XF.Jiang

For more information on these products consult: tech.support@psbel.com

NUCLEAR AND MEDICAL APPLICATIONS - Products are not designed or intended for use as critical components in life support systems, equipment used in hazardous environments, or nuclear control systems.

TECHNICAL REVISIONS - The appearance of products, including safety agency certifications pictured on labels, may change depending on the date manufactured. Specifications are subject to change without notice.



Asia-Pacific
+86 755 298 85888

Europe, Middle East
+353 61 225 977

North America
+1 408 785 5200