

Data sheet | Item number: 831-3627/108-000

THT male header; 1.0 x 1.2 mm solder pin; angled; 100% protected against mismatching; Threaded flange; Pin spacing 7.62 mm; 7-pole; light gray

www.wago.com/831-3627/108-000

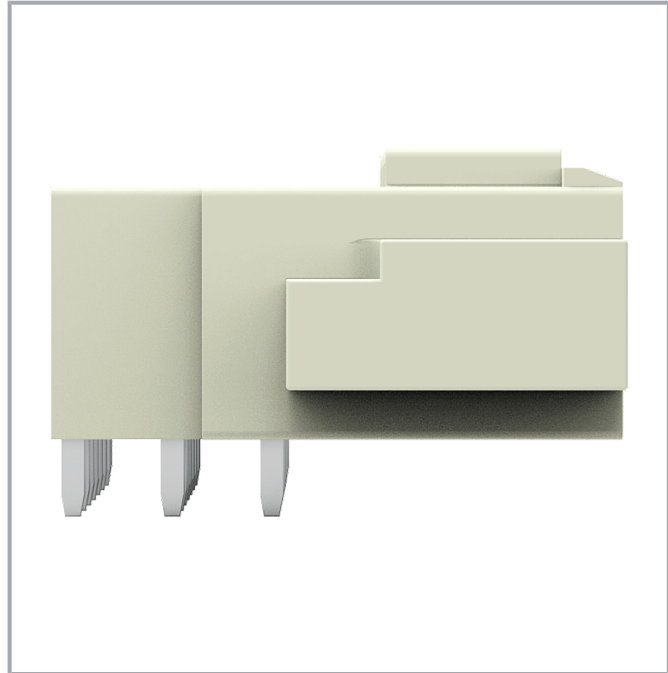
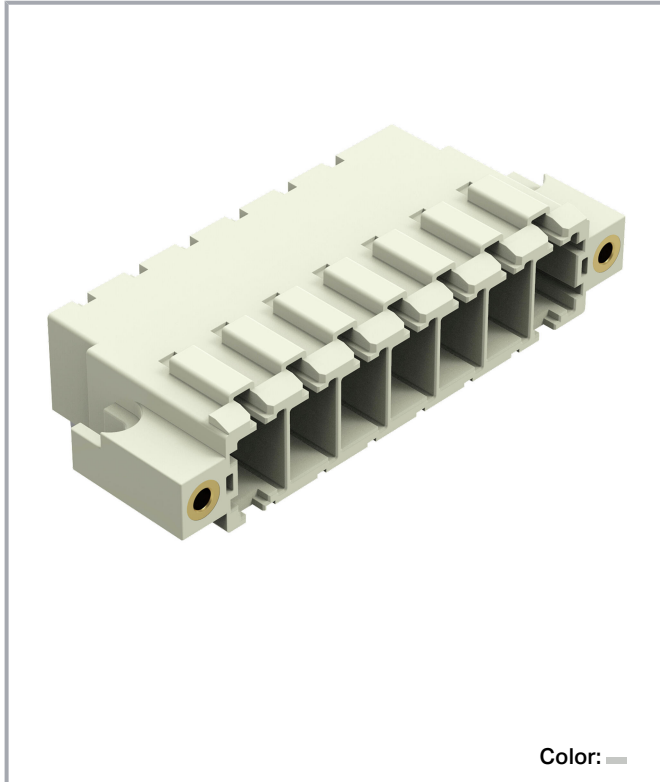

Subject to changes. Please also observe the further product documentation!

WAGO GmbH & Co. KG
Hansastr. 27
32423 Minden
Phone: +49571 887-0 | Fax: +49571 887-169
Email: info.de@wago.com | Web: www.wago.com

Do you have any questions about our products?
We are always happy to take your call at +49 (571) 887-44222.

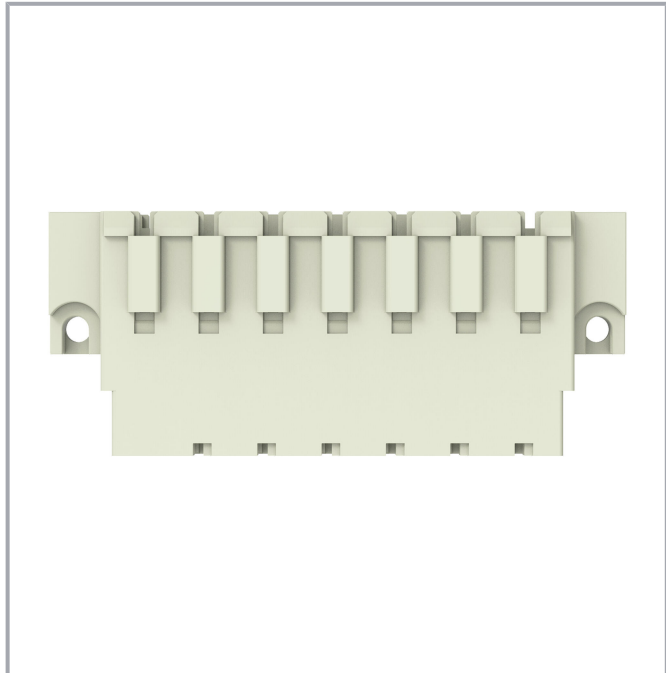
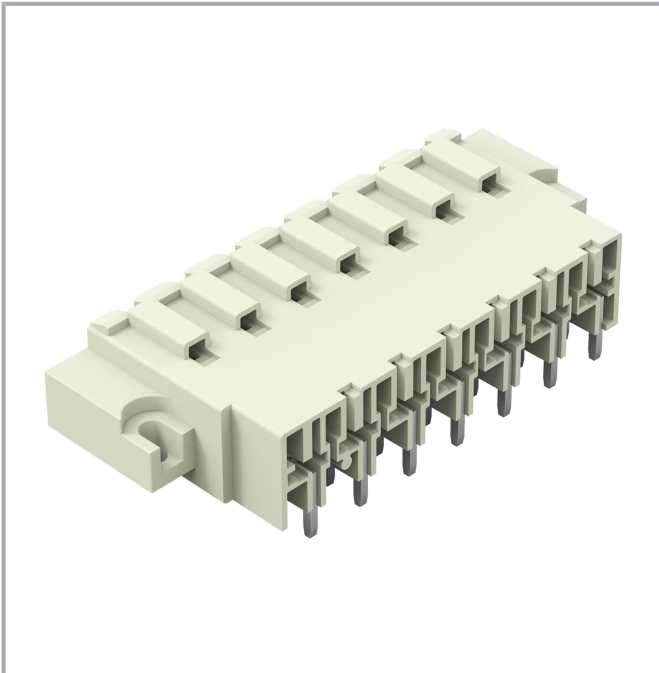

Derating Curve

1-conductor female connector (831-3102) with
THT male header (831-3622)

Pin spacing: 7.62 mm / Conductor cross-section: 6 mm² "f-st"
Based on: EN 60512-5-2 / Reduction factor: 0.8

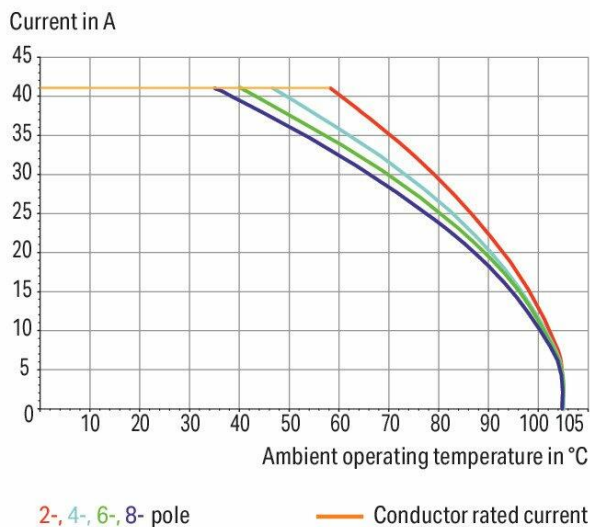

Derating Curve

1-conductor female connector (831-11xx) with
THT male header (831-36xx)

Pin spacing: 7.62 mm / Conductor cross-section: 6 mm² "f-st"
Based on: EN 60512-5-2 / Reduction factor: 0.8

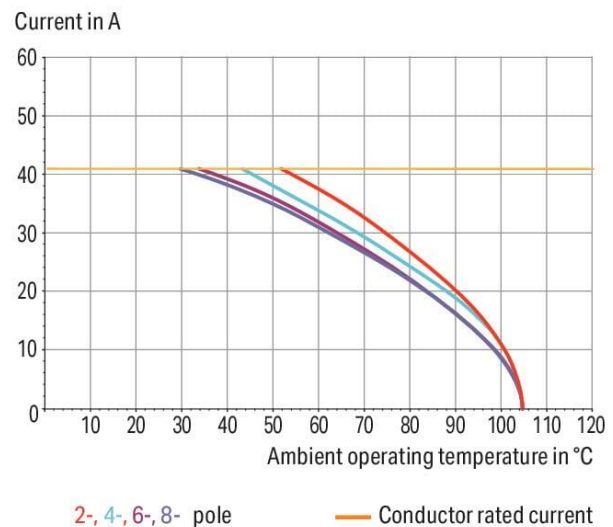

Subject to changes. Please also observe the further product documentation!

WAGO GmbH & Co. KG

Hansastr. 27

32423 Minden

Phone: +49571 887-0 | Fax: +49571 887-169

Email: info.de@wago.com | Web: www.wago.com

Do you have any questions about our products?

We are always happy to take your call at +49 (571) 887-44222.

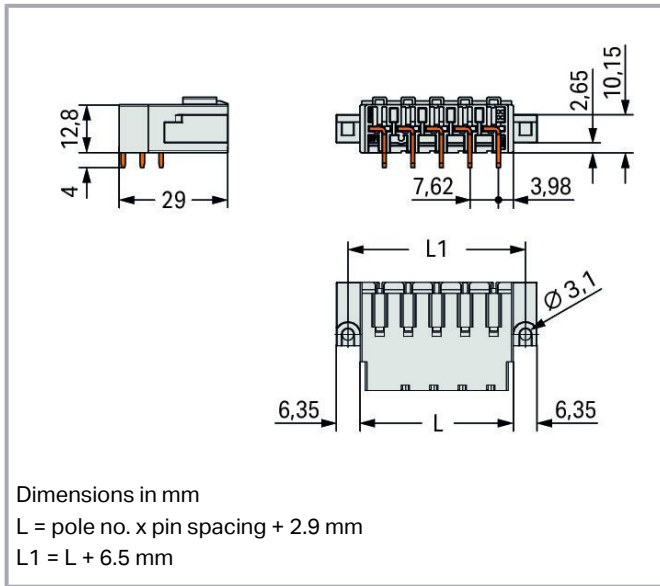

Item description

- Male headers may be mounted horizontally or vertically via straight or angled solder pins
- Three solder pins per pole provide high electrical and mechanical stability
- 100 % protected against mismatching
- Coding via coding fingers

Data

Notes

Safety information

The *MCS – MULTI CONNECTION SYSTEM* includes connectors without breaking capacity in accordance with DIN EN 61984. When used as intended, these connectors must not be connected /disconnected when live or under load. When used as intended, these connectors must not be connected/disconnected when live or under load. The circuit design should ensure header pins, which can be touched, are not live when unmated.

Variants:

Other pole numbers
 Protection against PCB mounting errors
 Other versions (or variants) can be requested from WAGO Sales or configured at <https://configurator.wago.com/>.

Electrical data

Subject to changes. Please also observe the further product documentation!



Ratings per IEC/EN

Ratings per	IEC/EN 60664-1
Nominal voltage (III/3)	500 V
Rated impulse voltage (III/3)	6 kV
Rated voltage (III/2)	630 V
Rated impulse voltage (III/2)	6 kV
Nominal voltage (II/2)	1000 V
Rated surge voltage (II/2)	6 kV
Rated current	41 A
Legend (ratings)	(III / 2) \triangleq Overvoltage category III / Pollution degree 2

Ratings per UL 1059

Approvals per	UL 1059
Rated voltage UL (Use Group C)	300 V
Rated current UL (Use Group C)	42 A
Rated voltage UL (Use Group D)	600 V
Rated current UL (Use Group D)	5 A

Ratings per CSA

Approvals per	CSA
Rated voltage CSA (Use Group C)	300 V
Rated current CSA (Use Group C)	41 A
Rated voltage CSA (Use Group D)	600 V
Rated current CSA (Use Group D)	5 A

Connection data

Total number of potentials	7
Number of connection types	1
Number of levels	1

Connection 1

Pole number	7
-------------	---

Physical data

Pin spacing	7.62 mm / 0.3 inches
-------------	----------------------

Subject to changes. Please also observe the further product documentation!



Width	68.9 mm / 2.714 inches
Height	18.8 mm / 0.74 inches
Height from the surface	14.8 mm / 0.583 inches
Depth	29 mm / 1.142 inches
Solder pin length	4 mm
Solder pin dimensions	1 x 1.2 mm
Drilled hole diameter with tolerance	1.7 ^(+0.1) mm

Mechanical Data

Variable coding	Yes
Anti-rotation protection	Yes

Plug-in connection

Contact type (pluggable connector)	Male connector/plug
Connector (connection type)	for PCB
Mismating protection	Yes
Plugging without loss of pin spacing	No
Mating direction to the PCB	0°
Locking of plug-in connection	Threaded flange

PCB contact

PCB contact	THT
Solder pin arrangement	over the entire male connector (in-line)
Number of solder pins per potential	3

Material Data

Note (material data)

Information on material specifications can be found here

Color	light gray
Material group	I
Insulation material	Polyamide (PA66)
Flammability class per UL94	V0
Contact material	Electrolytic copper (E _{Cu})
Contact plating	Tin
Weight	21.1 g

Subject to changes. Please also observe the further product documentation!

WAGO GmbH & Co. KG
 Hansastr. 27
 32423 Minden
 Phone: +49571 887-0 | Fax: +49571 887-169
 Email: info.de@wago.com | Web: www.wago.com

Do you have any questions about our products?
 We are always happy to take your call at +49 (571) 887-44222.

Environmental requirements

Limit temperature range	-60 ... +105 °C
Processing temperature	-35 ... +60 °C

Commercial data

ETIM 8.0	EC002637
ETIM 7.0	EC002637
PU (SPU)	12 pcs
Country of origin	PL
GTIN	4066966090000
Customs tariff number	85366990990

Environmental Product Compliance

RoHS Compliance Status	Compliant, No Exemption
------------------------	-------------------------

Approvals / Certificates

General approvals

Logo	Approval	Additional Approval Text	Certificate name
	CB DEKRA Certification B.V.	IEC 61984	NL-61360 /M1
	KEMA/KEUR DEKRA Certification B.V.	EN 61984	71-116057

Counterpart



Item no.831-3107/107-000

1-conductor female connector; Push-in CAGE CLAMP®; 10 mm²; Pin spacing 7.62 mm; 7-pole; 100% protected against mismatching; Screw flange; 10,00 mm²; light gray

www.wago.com/831-3107/107-000

Downloads

Documentation

Additional Information

Technical Section

Subject to changes. Please also observe the further product documentation!

WAGO GmbH & Co. KG

Hansastr. 27

32423 Minden

Phone: +49571 887-0 | Fax: +49571 887-169

Email: info.de@wago.com | Web: www.wago.com

Do you have any questions about our products?

We are always happy to take your call at +49 (571) 887-44222.

Technical explanations

2019 Apr 3

pdf
2.0 MB

[Download](#)

CAD/CAE-Data

CAD data

2D/3D Models 831-3627/108-000

[URL](#)

[Download](#)

CAE data

ZUKEN Portal 831-3627/108-000

[URL](#)

[Download](#)

Environmental Product Compliance

Compliance Search

Environmental Product Compliance 831-3627/108-000

[URL](#)

[Download](#)

THT male header; 1.0 x 1.2 mm solder pin; angled; 100% protected against mismatching; Threaded flange; Pin spacing 7.62 mm; 7-pole; light gray

Installation Notes

Coding

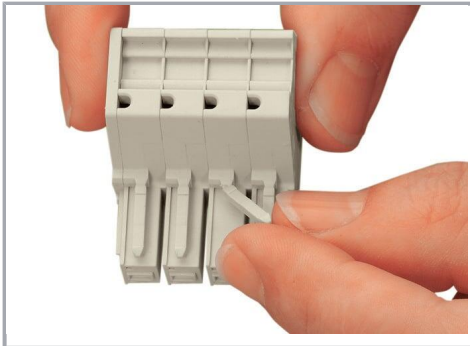

Break or cut off coding pin from female connector.

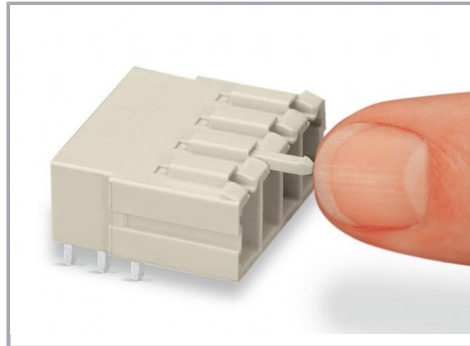

Insert coding pin into male header (break first) until it engages.

Subject to changes. Please also observe the further product documentation!

WAGO GmbH & Co. KG

Hansastr. 27

32423 Minden

Phone: +49571 887-0 | Fax: +49571 887-169

Email: info.de@wago.com | Web: www.wago.com

Do you have any questions about our products?

We are always happy to take your call at +49 (571) 887-44222.

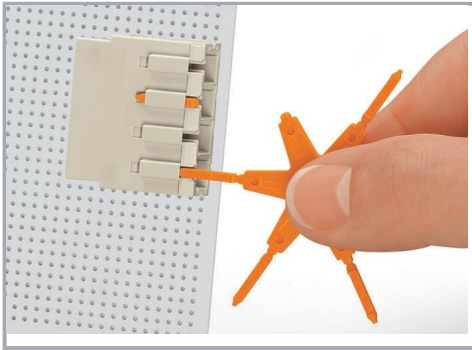

Coding a THT male header by inserting a coding pin.

Product family

MCS MAXI 6

[Show all products from the family](#)

Subject to changes. Please also observe the further product documentation!