

# High Power Chip Resistors (Wide Terminal Type)

ERJ A, B type

ERJ A1, B1, B2, B3 series

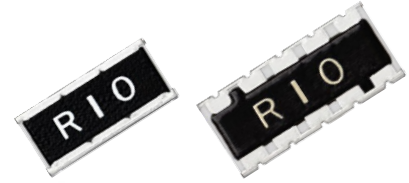

## Features

- High solder-joint reliability by wide terminal construction
- Excellent heat dissipation characteristics by wide terminal construction
- AEC-Q200 compliant
- RoHS compliant

## Recommended applications

- Automotive electronic circuits including ECUs (Electrical control unit), anti-lock breaking systems and air-bag systems.
- Current sensing for power supply circuits in a variety of equipment.

■ As for packaging methods, land pattern, soldering conditions and safety precautions, please see data files.

## Explanation of part numbers

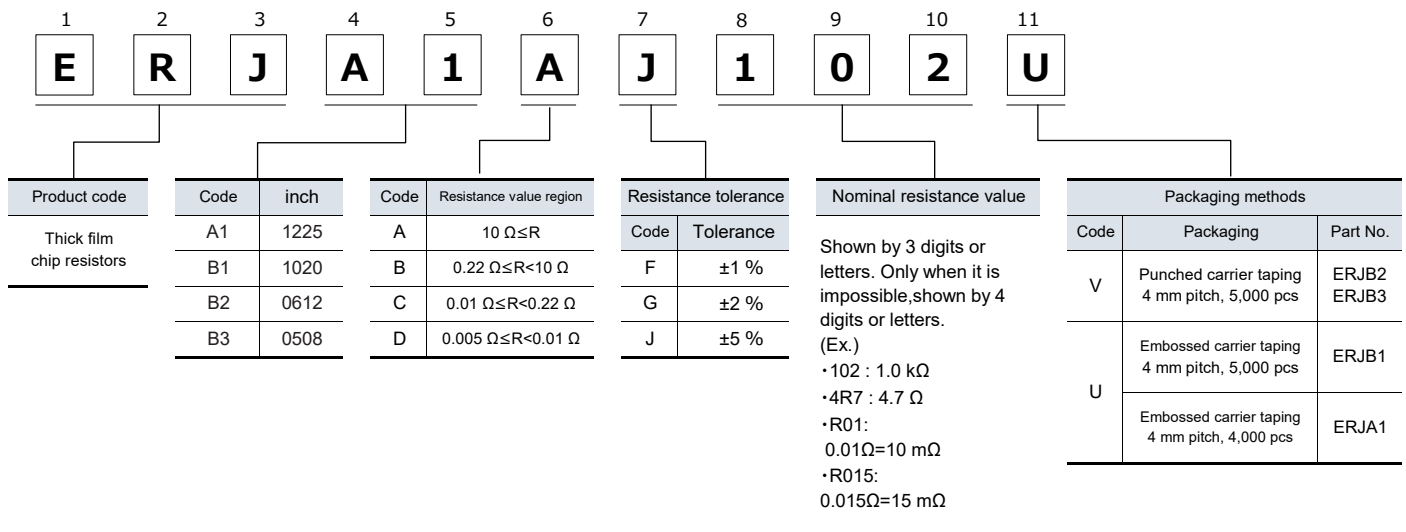

## High Power Chip Resistors (Wide Terminal Type)

### Ratings

Part No. (inch size)	Power rating <sup>*1</sup> (W)	Rated ambient temperature <sup>*2</sup> (°C)	Rated terminal part temperature <sup>*2</sup> (°C)	Limiting element voltage <sup>*3</sup> (V)	Maximum overload voltage <sup>*4</sup> (V)	Resistance tolerance (%)	Resistance range (Ω)	T.C.R. (×10 <sup>-6</sup> /K)	Category temperature range (°C)	AEC-Q200 Grade
ERJA1 (1225)	1.33	70	-	200	400	±1	100m to 10k (E24)	±100		
						±2, ±5	10m to 10k (E24)	10mΩ≤R<100mΩ : ±350 100mΩ≤R≤10kΩ : ±200		
ERJB1 (1020)	2 (R≤10Ω)	70	125	200	400	±1	10m to 10 (E24)	±1 % : 10mΩ≤R<22mΩ : 0 to +350 22mΩ≤R<47mΩ : 0 to +200 47mΩ≤R<100mΩ : 0 to +150 100mΩ≤R≤10kΩ : ±100	-55 ~ +155	Grade 0
						±2, ±5				
	1 (R>10Ω)	70	95			±1	11 to 10k (E24)	±2 %, ±5 % : 10mΩ≤R<22mΩ : 0 to +350 22mΩ≤R<100mΩ : 0 to +200 100mΩ≤R≤10kΩ : ±200		
						±2, ±5				
ERJB2 (0612)	1.5 (R≤1kΩ)	-	125	200	400	±1	10m to 1k (E24)	±1 % : 10mΩ≤R<22mΩ : 0 to +300 22mΩ≤R<47mΩ : 0 to +200 47mΩ≤R<100mΩ : 0 to +150 100mΩ≤R≤220mΩ : 0 to +100 220mΩ≤R≤1MΩ : ±100 ±2 %, ±5 % : 5mΩ≤R<22mΩ : 0 to +300 22mΩ≤R<47mΩ : 0 to +200 47mΩ≤R<100mΩ : 0 to +150 100mΩ≤R<220mΩ : 0 to +200 220mΩ≤R≤1MΩ : ±200		
						±2, ±5				
	0.75 (R>1kΩ)	-	90			±1	1.1k to 1M (E24)			
						±2, ±5				
	1 (R≤10Ω)	70	-			±1	10m to 10 (E24)			
						±2				
						±5	5, 6, 7, 8, 9, 10m to 10 (E24)			
±2, ±5										
ERJB3 (0508)	1	-	105	150	200	±1	20m to 10 (E24)	±1 % : 20mΩ≤R<47mΩ : 0 to +300 47mΩ≤R<1Ω : 0 to +200 1Ω≤R≤10Ω : ±100 ±2 %, ±5 % : 20mΩ≤R<47mΩ : 0 to +300 47mΩ≤R<1Ω : 0 to +200 1Ω≤R≤10Ω : ±200		
						±2, ±5				
	0.5 (R≤1Ω)	70	-			±1	20m to 1 (E24)			
±2, ±5										
0.33 (R>1Ω)	70	-	±1	1.1 to 10 (E24)						
			±2, ±5							

\*1: Use it on the condition that the case temperature is below the upper category temperature.

\*2: If there is a doubt whether the rated ambient temperature or the rated terminal part temperature is used, give priority to the rated terminal part temperature.

\*3: Rated Continuous Working Voltage (RCWV) shall be determined from  $RCWV = \sqrt{\text{Power Rating} \times \text{Resistance Value}}$ , or Limiting Element Voltage listed above, whichever less.

\*4: Overload Test Voltage (OTV) shall be determined from  $OTV = \text{Specified Magnification (refer to performance)} \times RCWV$  or Maximum Overload Voltage listed above, whichever less.

## High Power Chip Resistors (Wide Terminal Type)

### Ratings

#### Power derating curve

• For resistors operated in ambient rated ambient temperature, power rating shall be derated in accordance with the figure below.

In addition, please use under the condition that the product temperature is below the upper category temperature.

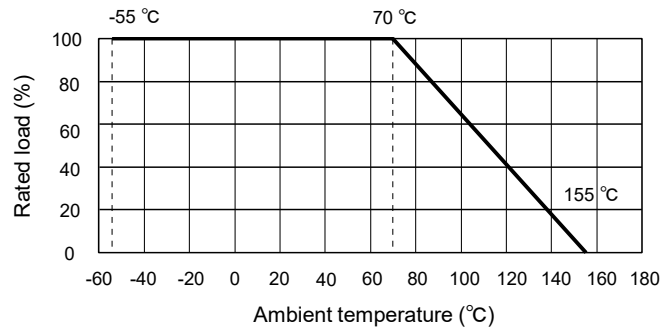

• For resistors operated in ambient rated terminal part temperature, power rating shall be derated in accordance with the figure below.

In addition, please use under the condition that the product temperature is below the upper category temperature.

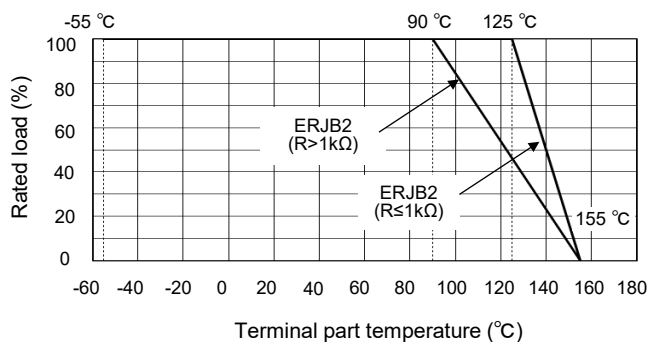
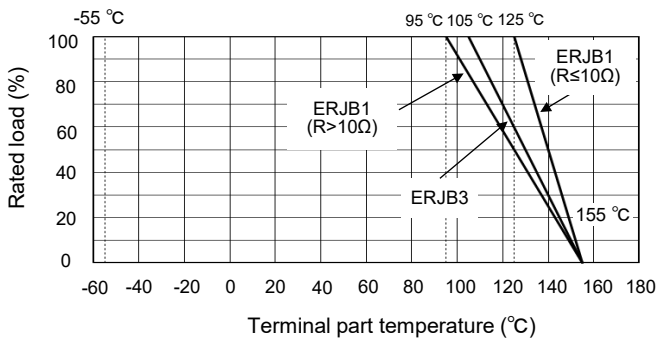

### Construction (Example : ERJA1 type)

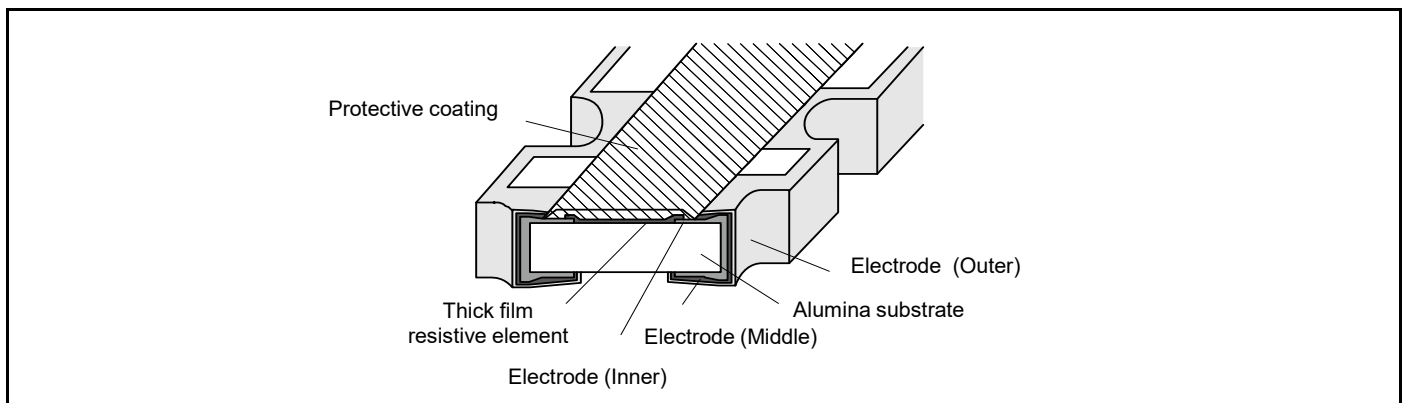

## High Power Chip Resistors (Wide Terminal Type)

### Dimensions (not to scale)

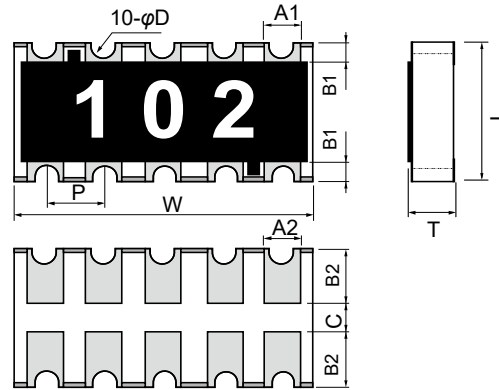

Part No.	Dimensions					Mass (Weight) (Reference) (g/1000 pcs)
	L	W	A <sub>1</sub>	B <sub>1</sub>	T	40
ERJA1	3.20±0.20	6.40±0.20	0.70±0.20	0.45±0.20	0.55±0.10	
	A <sub>2</sub>	B <sub>2</sub>	P	φD	C	
	0.70±0.20	1.25±0.15	1.27±0.10	0.30+0.10/-0.20	0.4 min.	

Unit : mm

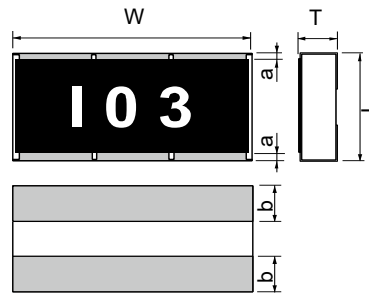

Part No.	Dimensions					Mass (Weight) (Reference) (g/1000 pcs)
	L	W	a	b	T	27
ERJB1	2.50±0.20	5.00±0.20	0.25±0.20	0.90±0.20	0.55±0.20	

Unit : mm

( R < 10 mΩ )

( 10 mΩ ≤ R ≤ 1 MΩ )

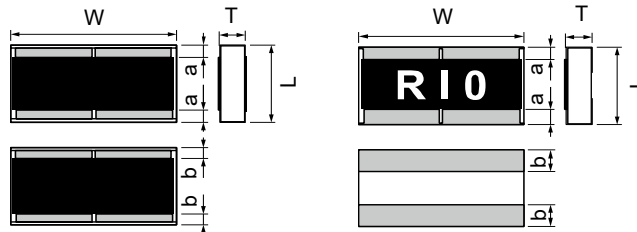

Part No.	Dimensions					Mass (Weight) (Reference) (g/1000 pcs)
	L	W	a	b	T	11
ERJB2						
5 mΩ ≤ R < 10 mΩ	1.60±0.15	3.20±0.20	0.30±0.20	0.30±0.20	0.65±0.15	
10 mΩ ≤ R < 220 mΩ			0.25±0.20	0.50±0.20	0.55±0.15	
220 mΩ ≤ R ≤ 1 MΩ						

Unit : mm

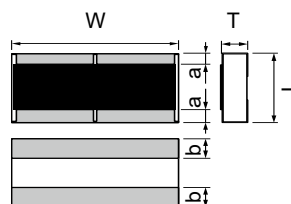

Part No.	Dimensions					Mass (Weight) (Reference) (g/1000 pcs)
	L	W	a	b	T	4.8
ERJB3	1.25±0.10	2.00±0.15	0.25±0.20	0.40±0.20	0.50±0.10	

Unit : mm

## High Power Chip Resistors (Wide Terminal Type)

### Circuit configuration

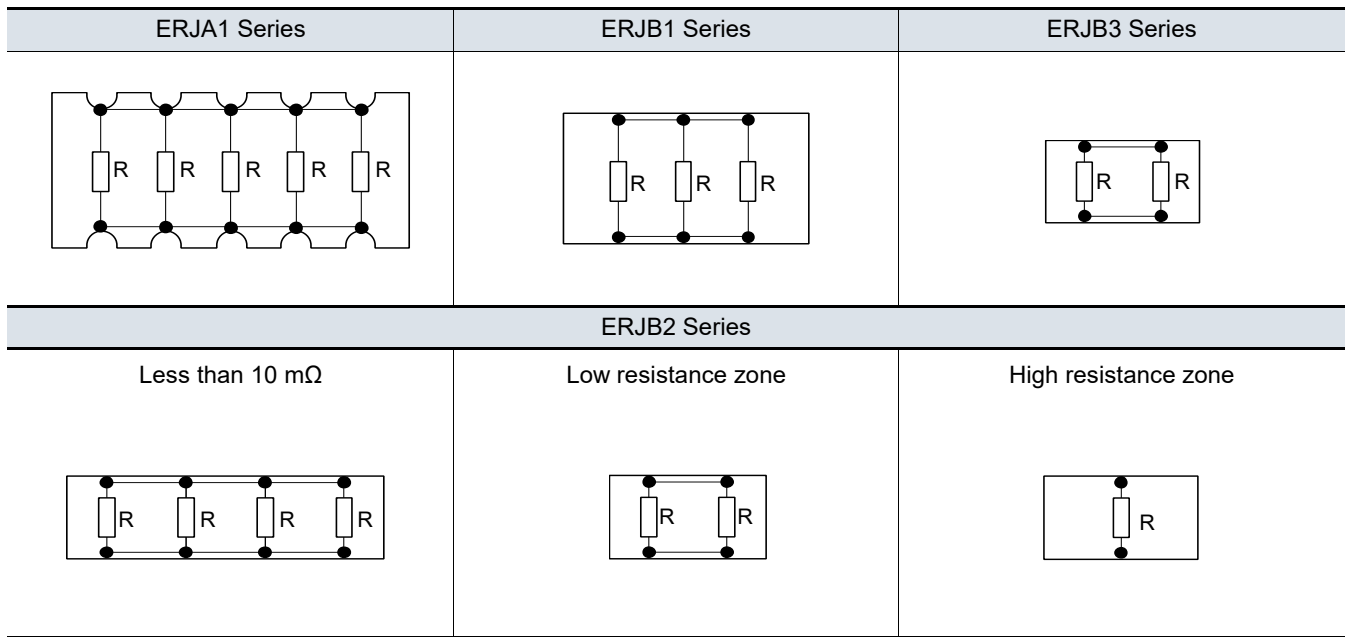

### Performance

Test Item	Performance requirements $\Delta R$	Test conditions
Resistance	Within specified tolerance	20 °C
T. C. R.	Within specified T. C. R.	+25 °C / +125 °C
Overload	$\pm 2$ %	ERJA1, ERJB1 (1W) : Rated voltage x 2.5, 5 s ERJB2 (0.75 W) : Rated voltage x 2.2, 5 s ERJB1 (2 W), ERJB2 (1.5 W, 1 W), ERJB3 : Rated voltage x 2.0, 5 s
Resistance to soldering heat	$\pm 1$ %	270 °C, 10 s
Rapid change of temperature	$\pm 2$ %	-55 °C (30 min.) / +125 °C (30 min.), 1000 cycles
High temperature exposure	$\pm 1$ %	+155 °C, 1000 h
Damp heat, Steady state	$\pm 1$ %	60 °C, 90 % to 95 %RH, 1000 h
Load life in humidity 1 <small>(Applicable to rated ambient temperature-regulated products)</small>	$\pm 3$ %	60 °C, 90 % to 95 %RH, Rated voltage 1.5 h ON / 0.5 h OFF cycle, 1000 h
Load life in humidity 2 <small>(Applicable to rated ambient temperature-regulated products)</small>	$\pm 3$ %	85 °C, 85 %RH, Rated power 10%, Continuously power, 1000 h
Durability at rated ambient temperature or rated terminal part temperature	$\pm 3$ %	Rated ambient temperature or rated terminal part temperature, Rated voltage, 1.5 h ON / 0.5 h OFF cycle, 1000 h

## **Guidelines and precautions regarding the technical information and use of our products described in this online catalog.**

- If you want to use our products described in this online catalog for applications requiring special qualities or reliability, or for applications where the failure or malfunction of the products may directly jeopardize human life or potentially cause personal injury (e.g. aircraft and aerospace equipment, traffic and transportation equipment, combustion equipment, medical equipment, accident prevention, anti-crime equipment, and/or safety equipment), it is necessary to verify whether the specifications of our products fit to such applications. Please ensure that you will ask and check with our inquiry desk as to whether the specifications of our products fit to such applications use before you use our products.
- The quality and performance of our products as described in this online catalog only apply to our products when used in isolation. Therefore, please ensure you evaluate and verify our products under the specific circumstances in which our products are assembled in your own products and in which our products will actually be used.
- Please ensure the safety by means of protection circuit, redundant circuit etc. in your system design in order to prevent the occurrence of life crisis and other serious damages due to the failure of our products.
- The products and product specifications described in this online catalog are subject to change for improvement without prior notice. Therefore, please be sure to request and confirm the latest product specifications which explain the specifications of our products in detail, before you finalize the design of your applications, purchase, or use our products.
- The technical information in this online catalog provides examples of our products' typical operations and application circuits. We do not guarantee the non-infringement of third party's intellectual property rights and we do not grant any license, right, or interest in our intellectual property.
- If any of our products, product specifications and/or technical information in this catalog is to be exported, the laws and regulations of the exporting country, especially with regard to security and export control, shall be observed.

## **<Regarding the Certificate of Compliance with the EU RoHS Directive/REACH Regulations>**

- The switchover date for compliance with the RoHS Directive/REACH Regulations varies depending on the part number or series of our products.
- When you use the inventory of our products for which it is unclear whether those products are compliant with the RoHS Directive/REACH Regulation, please select "Sales Inquiry" in the website inquiry form and contact us.

**Please note that we do not owe any liability and responsibility if our products are used beyond the description of this catalog or without complying with precautions in this catalog.**



## Application Guidelines (Fixed Resistors)

### 1. Safety precautions

- Make sure to exchange product specifications before using this product, regardless of the intended use. The design and specifications in this catalog are subject to change without prior notice.
- Do not use the products beyond the specifications described in this catalog.
- This catalog explains the quality and performance of the products as individual components. Before use, check and evaluate their operations when installed in your products under the actual conditions for use.
- If a malfunction of this product may result in the loss of human life or other serious damage in transportation equipment (trains, automobiles, ships, etc.), signaling equipment, medical equipment, aerospace equipment, electric heating equipment, combustion and gas equipment, rotating equipment, disaster prevention and security equipment, and other equipment, ensure safety by implementing a fail-safe design with the following system.
  - \* Systems equipped with a protection circuit and a protection device.
  - \* Systems equipped with a redundant circuit or other system to prevent an unsafe status in the event of a single fault.
  - \* Systems equipped with an arresting the spread of fire or preventing glitch.

### 2. Precautions for use

- These products are designed and manufactured for general and standard use in general electronic equipment (e.g. AV equipment, home electric appliances, office equipment, information and communication equipment). If the product is to be used in an application that requires special quality and reliability and where failure or malfunction of the product may directly threaten human life or cause bodily harm (e.g., aerospace equipment, transportation equipment, combustion equipment, medical equipment, disaster prevention and security equipment, safety devices, etc.), be sure to consult with our sales office in advance and exchange product specifications appropriate for the application.
- These products are not intended for use in the following special conditions. Before using the products, carefully check the effects on their quality and performance, and determine whether or not they can be used.
  1. In liquid, such as water, oil, chemicals, or organic solvent.
  2. In direct sunlight, outdoors, or in dust.
  3. In salty air or air with a high concentration of corrosive gas, such as  $\text{Cl}_2$ ,  $\text{H}_2\text{S}$ ,  $\text{NH}_3$ ,  $\text{SO}_2$ , or  $\text{NO}_x$ .
  4. Electric Static Discharge (ESD) Environment.  
These components are sensitive to static electricity and can be damaged under static shock (ESD). Please take measures to avoid any of these environments.  
Smaller components are more sensitive to ESD environment.
  5. Electromagnetic and Radioactive Environment.  
Avoid any environment where strong electromagnetic waves and radiation exist.
  6. In an environment where these products cause dew condensation.
  7. Sealing or coating of these products or a printed circuit board on which these products are mounted, with resin or other materials.
- These products generate Joule heat when energized. Carefully position these products so that their heat will not affect the other components.
- Carefully position these products so that their temperatures will not exceed the category temperature range due to the effects of neighboring heat-generating components. Do not mount or place heat-generating components or inflammables, such as vinyl-coated wires, near these products.
- Note that non-cleaning solder, halogen-based highly active flux, or water-soluble flux may deteriorate the performance or reliability of the products.
- Carefully select a flux cleaning agent for use after soldering. An unsuitable agent may deteriorate the performance or reliability. In particular, when using water or a water-soluble cleaning agent, be careful not to leave water residues. Otherwise, the insulation performance may be deteriorated.
- Do not apply flux to these products after soldering. The activity of flux may be a cause of failures in these products.
- Refer to the recommended soldering conditions and set the soldering condition. High peak temperature or long heating time may impair the performance or the reliability of these products.
- Recommended soldering condition is for the guideline for ensuring the basic characteristics of the products, not for the stable soldering conditions. Conditions for proper soldering should be set up according to individual conditions.
- Do not reuse any products after removal from mounting boards.
- Do not drop these products. If these products are dropped, do not use them. Such products may have received mechanical or electrical damage.
- If any doubt or concern to the safety on these products arise, make sure to inform us immediately and conduct technical examinations at your side.

### 3. Precautions for storage

The performance of these products, including the solderability, is guaranteed for a year from the date of arrival at your company, provided that they remain packed as they were when delivered and stored at a temperature of 5 °C to 35 °C and a relative humidity of 45 % to 85 %.

Even within the above guarantee periods, do not store these products in the following conditions. Otherwise, their electrical performance and/or solderability may be deteriorated, and the packaging materials (e.g. taping materials) may be deformed or deteriorated, resulting in mounting failures.

1. In salty air or in air with a high concentration of corrosive gas, such as Cl<sub>2</sub>, H<sub>2</sub>S, NH<sub>3</sub>, SO<sub>2</sub>, or NO<sub>x</sub>.
2. In direct sunlight.

<Package markings>

Package markings include the product number, quantity, and country of origin.

In principle, the country of origin should be indicated in English.

### 4. AEC-Q200 compliant

The products are tested based on all or part of the test conditions and methods defined in AEC-Q200. Please consult with Panasonic for the details of the product specification and specific evaluation test results, etc., make sure to exchange product specifications for each product when placing an order.





## Application Guidelines (Surface Mount Resistors)

The following are precautions for individual products. Please also refer to the common precautions for Fixed Resistors in this catalog.

1. Take measures against mechanical stress during and after mounting of Surface Mount Resistors (hereafter called the resistors) so as not to damage their electrodes and protective coatings.  
Be careful not to misplace the resistors on the land patterns. Otherwise, solder bridging may occur.
2. Keep the rated power and ambient temperature within the specified derating curve.  
Some circuit boards, wiring patterns, temperatures of heat generated by adjacent components, or ambient temperatures can become factors in the rise of the temperature of the resistors, regardless of the level of power applied. Therefore, check the conditions before use and optimize them so as not to damage the boards and peripheral components.  
Make sure to contact us before using the resistors under special conditions.
3. If a transient load (heavy load in a short time) like a pulse is expected to be applied, check and evaluate the operations of the resistors when installed in your products before use. Never exceed the rated power. Otherwise, the performance and/or reliability of the resistors may be impaired.
4. Transient voltage  
If there is a possibility that the transient phenomenon (significantly high voltage applied in a short time) may occur or that a high voltage pulse may be applied, make sure to evaluate and check the characteristics of resistors mounted on your product rather than only depending on the calculated power limit or steady-state conditions.
5. The electrical characteristics may change when used in high-frequency circuits, so check thoroughly before use.  
Such circuits change the electrical characteristics of the resistors.
6. Before using halogen-based or other high-activity flux, check the possible effects of the flux residues on the performance and reliability of the resistors.
7. When soldering with a soldering iron, never touch the resistors' bodies with the tip of the soldering iron.  
When using a soldering iron with a high temperature tip, finish soldering as quickly as possible (within three seconds at 350 °C max.).
8. The connection reliability and performance may be affected if the amount of solder is too much or too little.  
Check the performance and reliability of the product and use an appropriate amount of solder.
9. When the resistors' protective coatings are chipped, flawed, or removed, the characteristics of the resistors may be impaired. Take special care not to apply mechanical shock during automatic mounting or cause damage during handling of the boards with the resistors mounted.
10. Do not apply shock to the resistors or pinch them with a hard tool (e.g. pliers and tweezers). Otherwise, the resistors' protective coatings and bodies may be chipped, affecting their performance.
11. Avoid excessive bending of printed circuit boards in order to protect the resistors from abnormal stress.
12. Do not immerse the resistors in solvent for a long time.  
Before using solvent, carefully check the effects of immersion.
13. Do not apply excessive tension to the terminals.