

NCP304A

Voltage Detector Series

The NCP304A is a second generation ultra-low current voltage detector. This device is specifically designed for use as a reset controller in portable microprocessor based systems where extended battery life is paramount.

This device features a highly accurate undervoltage detector with hysteresis which prevents erratic system reset operation as the comparator threshold is crossed.

The NCP304A consists of complementary output devices that are available with either an active high or active low reset output.

The NCP304A is available in the SC-82AB package with standard undervoltage thresholds. Additional thresholds that range from 0.9 V to 4.9 V in 100 mV steps can be manufactured.

Features

- Quiescent Current of 1.0 μ A Typical
- High Accuracy Undervoltage Threshold of 2.0%
- Wide Operating Voltage Range of 0.8 V to 10 V
- Complementary Output
- Active Low or Active High Reset Output
- This is a Pb-Free Device

Typical Applications

- Microprocessor Reset Controller
- Low Battery Detection
- Power Fail Indicator
- Battery Backup Detection

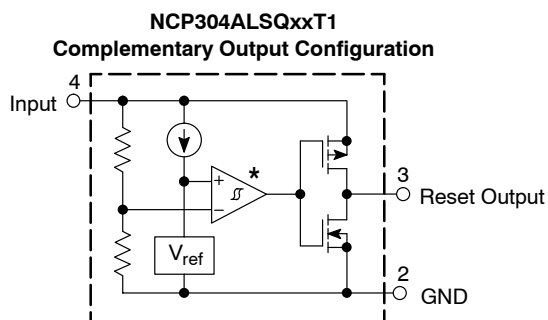

This device contains 38 active transistors.

*The representative block diagram depicts active low reset output 'L' suffix devices. The comparator input is interchanged for the active high output 'H' suffix devices.

Figure 1. Representative Block Diagrams



ON Semiconductor®

<http://onsemi.com>

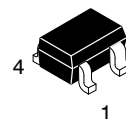

SC-82AB
SQ SUFFIX
CASE 419C

PIN CONNECTIONS AND MARKING DIAGRAM

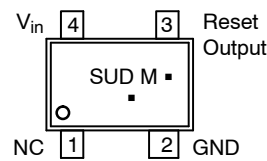

(Top View)

SUD = Specific Device Code
M = Date Code
■ = Pb-Free Package

(Note: Microdot may be in either location)

ORDERING INFORMATION

See detailed ordering and shipping information in the ordering information section on page 5 of this data sheet.

NCP304A

MAXIMUM RATINGS (Note 1)

Rating	Symbol	Value	Unit
Input Power Supply Voltage (Pin 4)	V_{in}	12	V
Output Voltage (Pin 3) Complementary, NCP304A	V_{OUT}	-0.3 to $V_{in}+0.3$	V
Output Current (Pin 3) (Note 2)	I_{OUT}	70	mA
Thermal Resistance, Junction-to-Air	$R_{\theta JA}$	285	$^{\circ}C/W$
Maximum Junction Temperature	T_J	+125	$^{\circ}C$
Storage Temperature Range	T_{stg}	-55 to +150	$^{\circ}C$
Latchup Performance (Note 3) Positive Negative	$I_{LATCHUP}$	500 170	mA

Stresses exceeding Maximum Ratings may damage the device. Maximum Ratings are stress ratings only. Functional operation above the Recommended Operating Conditions is not implied. Extended exposure to stresses above the Recommended Operating Conditions may affect device reliability.

- This device series contains ESD protection and exceeds the following tests:
Human Body Model 2000 V per MIL-STD-883, Method 3015.
Machine Model Method 200 V.

- The maximum package power dissipation limit must not be exceeded.

$$P_D = \frac{T_J(\max) - T_A}{R_{\theta JA}}$$

- Maximum Ratings per JEDEC standard JESD78.

ELECTRICAL CHARACTERISTICS (For all values $T_A = 25^{\circ}C$, unless otherwise noted.)

Characteristic	Symbol	Min	Typ	Max	Unit
NCP304A - 4.3					
Detector Threshold (Pin 4, V_{in} Decreasing)	V_{DET-}	4.214	4.3	4.386	V
Detector Threshold Hysteresis (Pin 4, V_{in} Increasing)	V_{HYS}	0.129	0.225	0.301	V
Supply Current (Pin 4) ($V_{in} = 4.14$ V) ($V_{in} = 6.3$ V)	I_{in}	- -	- -	3.0 3.9	μA
Maximum Operating Voltage (Pin 4)	$V_{in(max)}$	-	-	10	V
Minimum Operating Voltage (Pin 4) ($T_A = -40^{\circ}C$ to $85^{\circ}C$)	$V_{in(min)}$	- -	0.55 0.65	0.70 0.80	V
Reset Output Current (Pin 3, Active Low 'L' Suffix Devices) N-Channel Sink Current, NCP304A ($V_{OUT} = 0.05$ V, $V_{in} = 0.70$ V) ($V_{OUT} = 0.50$ V, $V_{in} = 1.5$ V) P-Channel Source Current, NCP304A ($V_{OUT} = 5.9$ V, $V_{in} = 8.0$ V)	I_{OUT}	0.01 1.0 1.5	0.05 2.0 3.0	- - -	mA
Reset Output Current (Pin 3, Active High 'H' Suffix Devices) N-Channel Sink Current, NCP304A ($V_{OUT} = 0.5$ V, $V_{in} = 5.0$ V) P-Channel Source Current, NCP304A ($V_{OUT} = 0.4$ V, $V_{in} = 0.7$ V) ($V_{OUT} = GND$, $V_{in} = 1.5$ V)	I_{OUT}	6.3 0.011 0.525	11 0.04 0.6	- - -	mA
Propagation Delay Input to Output (Figure 2) NCP304A Series Output Transition, High to Low (Note 4) Output Transition, Low to High (Note 4)	t_{pHL} t_{pLH}	- -	10 21	- 60	μs

- The time interval between the rising edge of V_{DD} input pulse from 0.7 V to $(+V_{DET}) + 2.0$ V and output voltage level becoming to $V_{DD}/2$.

NCP304A

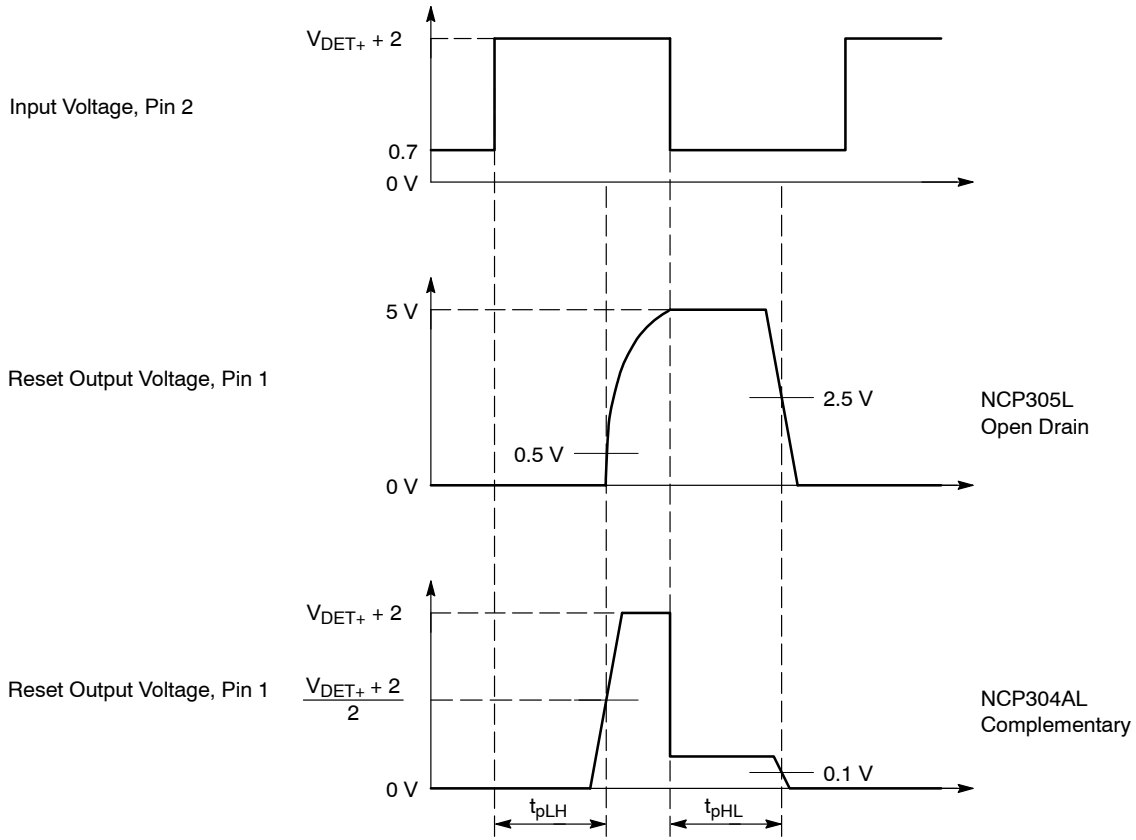

NCP304A is measured with a 10 pF capacitive load. The reset output voltage waveforms are shown for the active low 'L' devices. The upper detector threshold, V_{DET+} is the sum of the lower detector threshold, V_{DET-} plus the input hysteresis, V_{HYS} .

Figure 2. Propagation Delay Measurement Conditions

Table 1. NCP304A SERIES ELECTRICAL CHARACTERISTIC TABLE FOR 0.9 – 4.9 V

Part Number	Detector Threshold			Detector Threshold Hysteresis			Supply Current		N-Channel Sink Current		P-Channel Source Current
							V_{in} Low	V_{in} High	V_{in} Low	V_{in} High	
	V_{DET-} (V)			V_{HYS} (V)			I_{in} (μA) (Note 5)	I_{in} (μA) (Note 6)	I_{OUT} (mA) (Note 7)	I_{OUT} (mA) (Note 8)	I_{OUT} (mA) (Note 9)
	Min	Typ	Max	Min	Typ	Max	Typ	Typ	Typ	Typ	
NCP304ALSQ43T1	4.214	4.3	4.386	0.129	0.215	0.301	1.1	1.3			3.0

5. $V_{in} = V_{DET-} - 0.16 V$

6. Condition 2: $V_{in} = V_{DET-} + 2.0 V$

7. Condition 3: $V_{in} = 0.7 V$, $V_{OUT} = 0.05 V$, Active Low 'L' Suffix Devices

8. Condition 4: $V_{in} = 1.5 V$, $V_{OUT} = 0.5 V$, Active Low 'L' Suffix Devices

9. Condition 5: $V_{in} = 8.0 V$, $V_{OUT} = 5.9 V$, Active Low 'L' Suffix Devices

NCP304A

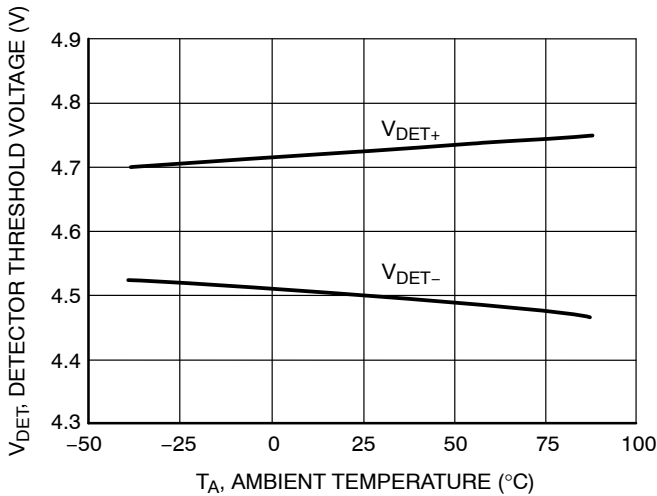

**Figure 3. NCP304A Series 4.5 V
Detector Threshold Voltage vs. Temperature**

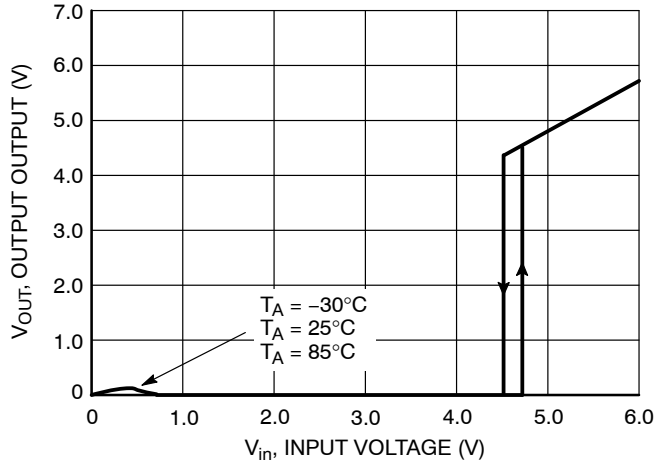

**Figure 4. NCP304AL Series 4.5 V
Reset Output Voltage vs. Input Voltage**

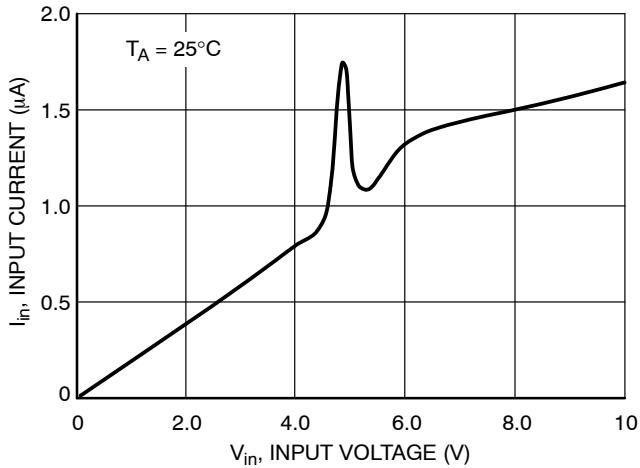

**Figure 5. NCP304A Series 4.5 V
Input Current vs. Input Voltage**

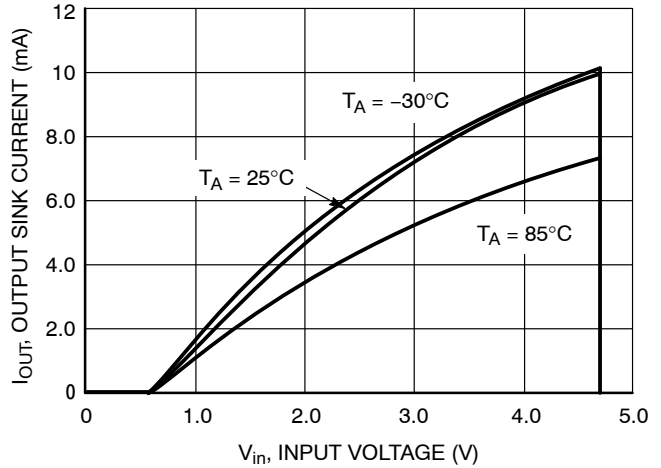

**Figure 6. NCP304AH Series 4.5 V
Reset Output Sink Current vs. Input Voltage**

OPERATING DESCRIPTION

The NCP304A is a second generation ultra-low current voltage detectors. Figures 7 and 8 show a timing diagram and a typical application. Initially consider that input voltage V_{in} is at a nominal level and it is greater than the voltage detector upper threshold (V_{DET+}), and the reset output (Pin 3) will be in the high state for active low devices, or in the low state for active high devices. If there is a power interruption and V_{in} becomes significantly deficient, it will fall below the lower detector threshold (V_{DET-}). This sequence of events causes the Reset output to be in the low

state for active low devices, or in the high state for active high devices. After completion of the power interruption, V_{in} will again return to its nominal level and become greater than the V_{DET+} . The voltage detector has built-in hysteresis to prevent erratic reset operation as the comparator threshold is crossed.

Although this device is specifically designed for use as a reset controller in portable microprocessor based systems, it offers a cost-effective solution in numerous applications where precise voltage monitoring is required.

NCP304A

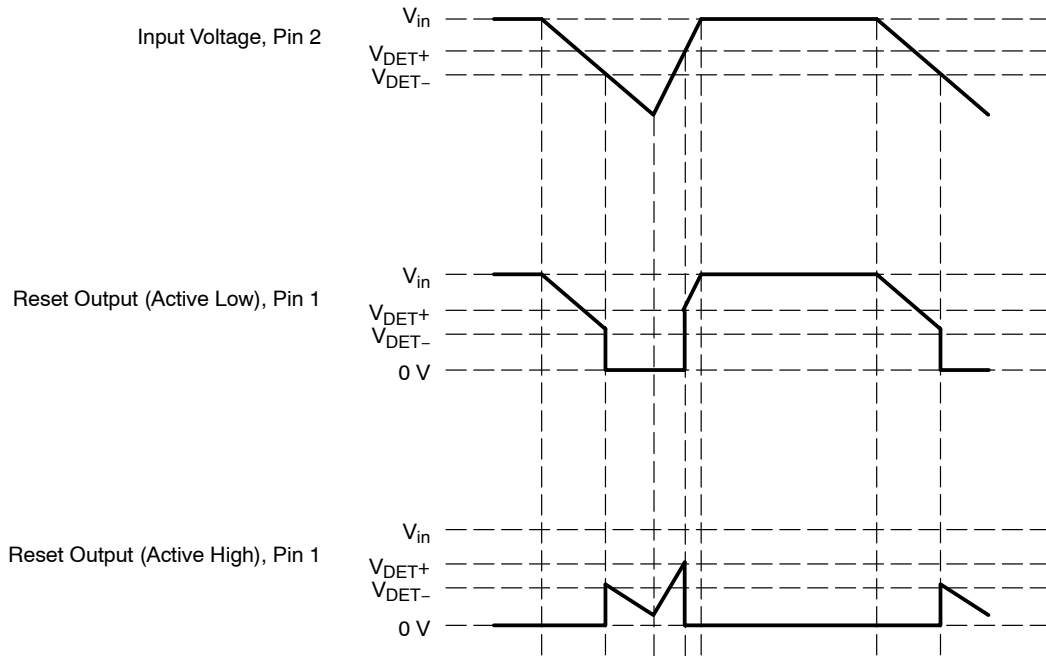

Figure 7. Timing Waveforms

APPLICATION CIRCUIT INFORMATION

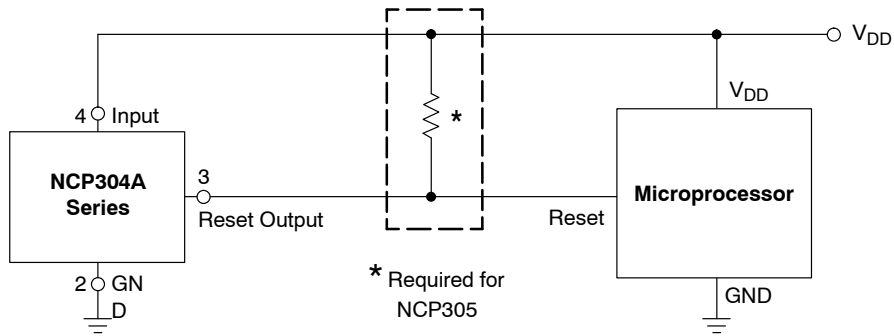

Figure 8. Microprocessor Reset Circuit

ORDERING INFORMATION

Device	Threshold Voltage	Output Type	Reset	Marking	Package	Shipping [†]
NCP304ALSQ43T1G	4.3	CMOS	Active Low	SUD	SC-82AB (Pb-Free)	3000 / Tape & Reel

NOTE: Additional active low threshold devices, ranging from 0.9 V to 4.9 V in 100 mV increments and NCP304A active high output devices, ranging from 0.9 V to 4.9 V in 100 mV increments can be manufactured. Contact your ON Semiconductor representative for availability.
[†]For information on tape and reel specifications, including part orientation and tape sizes, please refer to our Tape and Reel Packaging Specifications Brochure, BRD8011/D.

MECHANICAL CASE OUTLINE

PACKAGE DIMENSIONS

ON Semiconductor®

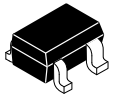

SC-82AB
CASE 419C-02
ISSUE F

DATE 22 JUN 2012

SCALE 4:1

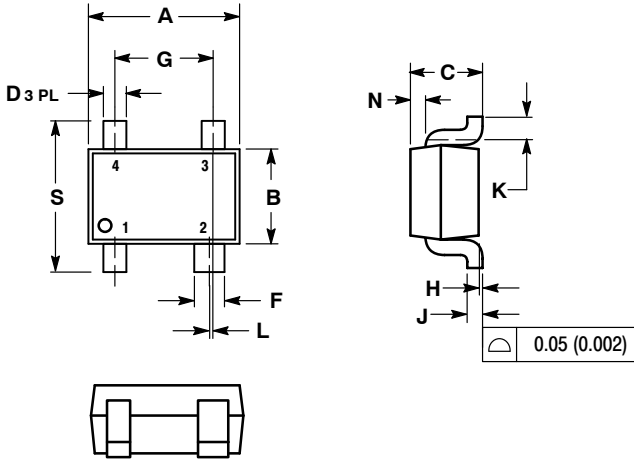

NOTES:

1. DIMENSIONING AND TOLERANCING PER ANSI Y14.5M, 1982.
2. CONTROLLING DIMENSION: MILLIMETER.
3. 419C-01 OBSOLETE. NEW STANDARD IS 419C-02.
4. DIMENSIONS A AND B DO NOT INCLUDE MOLD FLASH, PROTRUSIONS, OR GATE BURRS.

DIM	MILLIMETERS		INCHES	
	MIN	MAX	MIN	MAX
A	1.80	2.20	0.071	0.087
B	1.15	1.35	0.045	0.053
C	0.80	1.10	0.031	0.043
D	0.20	0.40	0.008	0.016
F	0.30	0.50	0.012	0.020
G	1.10	1.50	0.043	0.059
H	0.00	0.10	0.000	0.004
J	0.10	0.26	0.004	0.010
K	0.10	---	0.004	---
L	0.05 BSC		0.002 BSC	
N	0.20 REF		0.008 REF	
S	1.80	2.40	0.07	0.09

SOLDERING FOOTPRINT*

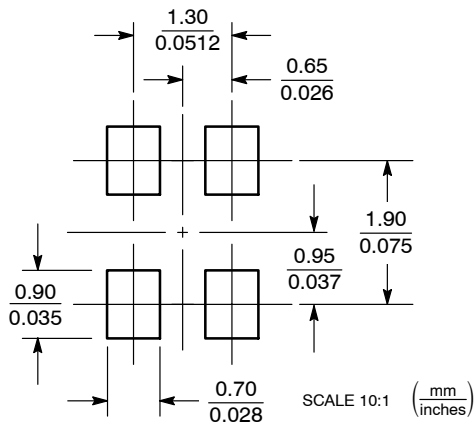

GENERIC MARKING DIAGRAM*

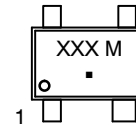

- XXX = Specific Device Code
- M = Month Code
- = Pb-Free Package

*This information is generic. Please refer to device data sheet for actual part marking. Pb-Free indicator, "G" or microdot "▪", may or may not be present.

*For additional information on our Pb-Free strategy and soldering details, please download the ON Semiconductor Soldering and Mounting Techniques Reference Manual, SOLDERRM/D.

DOCUMENT NUMBER:	98ARB18939C	Electronic versions are uncontrolled except when accessed directly from the Document Repository. Printed versions are uncontrolled except when stamped "CONTROLLED COPY" in red.
DESCRIPTION:	SC-82AB	PAGE 1 OF 1

ON Semiconductor and ON are trademarks of Semiconductor Components Industries, LLC dba ON Semiconductor or its subsidiaries in the United States and/or other countries. ON Semiconductor reserves the right to make changes without further notice to any products herein. ON Semiconductor makes no warranty, representation or guarantee regarding the suitability of its products for any particular purpose, nor does ON Semiconductor assume any liability arising out of the application or use of any product or circuit, and specifically disclaims any and all liability, including without limitation special, consequential or incidental damages. ON Semiconductor does not convey any license under its patent rights nor the rights of others.

onsemi, **Onsemi**, and other names, marks, and brands are registered and/or common law trademarks of Semiconductor Components Industries, LLC dba "**onsemi**" or its affiliates and/or subsidiaries in the United States and/or other countries. **onsemi** owns the rights to a number of patents, trademarks, copyrights, trade secrets, and other intellectual property. A listing of **onsemi**'s product/patent coverage may be accessed at www.onsemi.com/site/pdf/Patent-Marking.pdf. **onsemi** reserves the right to make changes at any time to any products or information herein, without notice. The information herein is provided "as-is" and **onsemi** makes no warranty, representation or guarantee regarding the accuracy of the information, product features, availability, functionality, or suitability of its products for any particular purpose, nor does **onsemi** assume any liability arising out of the application or use of any product or circuit, and specifically disclaims any and all liability, including without limitation special, consequential or incidental damages. Buyer is responsible for its products and applications using **onsemi** products, including compliance with all laws, regulations and safety requirements or standards, regardless of any support or applications information provided by **onsemi**. "Typical" parameters which may be provided in **onsemi** data sheets and/or specifications can and do vary in different applications and actual performance may vary over time. All operating parameters, including "Typicals" must be validated for each customer application by customer's technical experts. **onsemi** does not convey any license under any of its intellectual property rights nor the rights of others. **onsemi** products are not designed, intended, or authorized for use as a critical component in life support systems or any FDA Class 3 medical devices or medical devices with a same or similar classification in a foreign jurisdiction or any devices intended for implantation in the human body. Should Buyer purchase or use **onsemi** products for any such unintended or unauthorized application, Buyer shall indemnify and hold **onsemi** and its officers, employees, subsidiaries, affiliates, and distributors harmless against all claims, costs, damages, and expenses, and reasonable attorney fees arising out of, directly or indirectly, any claim of personal injury or death associated with such unintended or unauthorized use, even if such claim alleges that **onsemi** was negligent regarding the design or manufacture of the part. **onsemi** is an Equal Opportunity/Affirmative Action Employer. This literature is subject to all applicable copyright laws and is not for resale in any manner.

PUBLICATION ORDERING INFORMATION

LITERATURE FULFILLMENT:

Email Requests to: orderlit@onsemi.com

onsemi Website: www.onsemi.com

TECHNICAL SUPPORT

North American Technical Support:

Voice Mail: 1 800-282-9855 Toll Free USA/Canada

Phone: 011 421 33 790 2910

Europe, Middle East and Africa Technical Support:

Phone: 00421 33 790 2910

For additional information, please contact your local Sales Representative