



## 9 dB Fixed Attenuator, 2.92mm Male to 2.92mm Female Passivated Stainless Steel Body Rated to 0.5 Watts Up to 40 GHz

### RF Fixed Attenuators Technical Data Sheet

PE7AP412-09

#### Features

- DC to 40 GHz Frequency Range
- Attenuation 8±1.2 dB
- Max Power 0.5 Watt (CW)
- VSWR < 1.4:1

#### Applications

- Instrumentation
- Precision measurements
- Prototyping and characterization
- Production systems

#### Description

Pasternack carries a wide range of fixed attenuators with a broad selection of attenuation levels, frequency ranges, and power dissipation ranges. RF microwave attenuators (also known as RF pads) lower the amplitude of a signal (attenuate) a known amount and can be used in a wide variety of applications. These attenuator pads are used when a signal needs to be reduced to protect measurement equipment or other circuitry, to extend the range of power meters and amplifiers, and to impedance match circuits by reducing the VSWR seen by adjacent components. RF attenuators can prevent signal overload in amplifiers, receivers and detectors, adjusting the signal level to a range that is optimal.

Few RF components are as commonly used as fixed coaxial attenuators, and Pasternack carries one of the largest in-stock varieties and ships them same day. The 9 dB Fixed Attenuator PE7AP412-09 is rated to 0.5 Watts and operates from DC to 40 GHz. The versatile coaxial package uses 2.92mm male to 2.92mm female connectors and is also REACH and RoHS compliant.

#### Electrical Specifications

Description	Minimum	Typical	Maximum	Units
Frequency Range	DC		40	GHz
Impedance		50		Ohms
Nominal Attenuation		9		dB
VSWR			1.4:1	
Input Power, CW derated linearly to 0.05W at +125°C			0.5	Watts

#### Specifications by Frequency

Description	F1	F2	F3	F4	F5	Units
Range	DC to 18	18 to 26.5	26.5 to 40			GHz
VSWR, Max	1.3:1	1.4:1	1.4:1			
Attenuation Accuracy, Typ	0.5	0.5	0.8			dB

Click the following link (or enter part number in "SEARCH" on website) to obtain additional part information including price, inventory and certifications: [9 dB Fixed Attenuator, 2.92mm Male to 2.92mm Female Passivated Stainless Steel Body Rated to 0.5 Watts Up to 40 GHz PE7AP412-09](#)



9 dB Fixed Attenuator, 2.92mm Male to 2.92mm Female  
 Passivated Stainless Steel Body Rated to 0.5 Watts Up to 40 GHz

## RF Fixed Attenuators Technical Data Sheet

PE7AP412-09

### Mechanical Specifications

#### Size

Length	0.87 in [22.1 mm]
Width/Diameter	0.315 in [8 mm]
Weight	0.013 lbs [5.9 g]
Body Material and Plating	Passivated Stainless Steel

#### Configuration

Design	Fixed
Package Style	Connectorized Module

#### Connectors

Description	Connector 1	Connector 2
Type	2.92mm Male	2.92mm Female
Contact Material and Plating	Beryllium Copper, Gold	Beryllium Copper, Gold
Contact Plating Specification	MIL-PRF-39012	MIL-PRF-39012
Hex Size	5/16 inch	
Body Material and Plating	Passivated Stainless Steel	Passivated Stainless Steel

Mechanical Specification Notes:  
 The connectors use high temperature plastic bead dielectric.

### Environmental Specifications

#### Temperature

Operating Range	-55 to +125 deg C
-----------------	-------------------

**Compliance Certifications** (see [product page](#) for current document)

### Plotted and Other Data

Notes:

9 dB Fixed Attenuator, 2.92mm Male to 2.92mm Female Passivated Stainless Steel Body Rated to 0.5 Watts Up to 40 GHz from Pasternack Enterprises has same day shipment for domestic and International orders. Our RF, microwave and millimeter wave products maintain a 99.4% availability and are part of the broadest selection in the industry.

Click the following link (or enter part number in "SEARCH" on website) to obtain additional part information including price, inventory and certifications: [9 dB Fixed Attenuator, 2.92mm Male to 2.92mm Female Passivated Stainless Steel Body Rated to 0.5 Watts Up to 40 GHz PE7AP412-09](#)

URL: <https://www.pasternack.com/9db-fixed-2.92mm-male-2.92mm-female-0.5-watts-attenuator-pe7ap412-09-p.aspx>

# PE7AP412-09 CAD Drawing

9 dB Fixed Attenuator, 2.92mm Male to 2.92mm Female Passivated  
Stainless Steel Body Rated to 0.5 Watts Up to 40 GHz

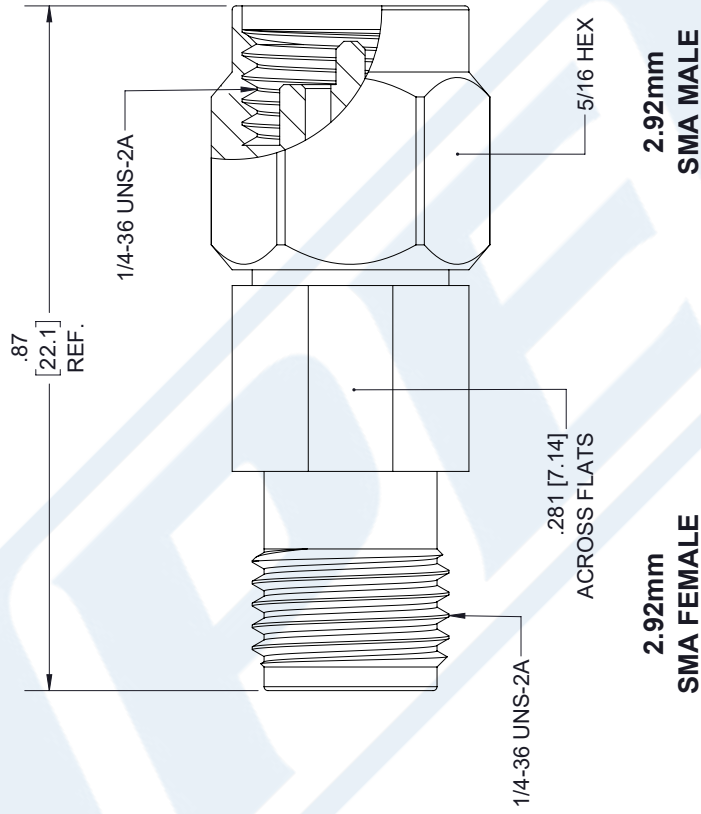
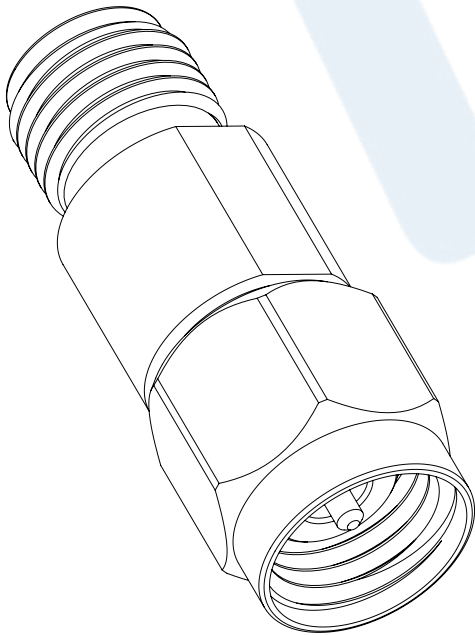

### STANDARD TOLERANCES

.X ±0.2  
.XX ±0.01  
.XXX ±0.005

\*STANDARD TOLERANCES APPLY ONLY TO DIMENSIONS IN INCHES



Pasternack Enterprises, Inc.  
P.O. Box 16759 | Irvine | CA | 92623  
Phone: (949) 261-1920 | Fax: (949) 261-7451  
Website: [www.pasternack.com](http://www.pasternack.com) | E-Mail: [sales@pasternack.com](mailto:sales@pasternack.com)

DWG TITLE

PE7AP412-09

NOTES:  
1. UNLESS OTHERWISE SPECIFIED ALL DIMENSIONS ARE NOMINAL.  
2. ALL SPECIFICATIONS ARE SUBJECT TO CHANGE WITHOUT NOTICE AT ANY TIME.  
3. DIMENSIONS ARE IN INCHES [mm].

CAGE CODE 53919

CAD FILE 07/03/18

SCALE N/A

SIZE A

7361