

DELTA ELECTRONICS, INC.  
 252, SHANG YING ROAD, KUEI SAN  
 TAOYUAN HSIEN 333, TAIWAN, R. O. C.

TEL : 886-(0)3-3591968  
 FAX : 886-(0)3-3591991

SPECIFICATION FOR APPROVAL  
 \*\*\*\*\*

Customer:

Description:	DC FAN		
Customer P/N:		REV:	
Delta Model NO.:	TFA0948AE		
Sample Rev:	01	Issue NO:	
Sample Issue Date:	MAR.24.2011	Quantity:	

1. SCOPE:

THIS SPECIFICATION DEFINES THE ELECTRICAL AND MECHANICAL CHARACTERISTICS OF THE DC BRUSHLESS AXIAL FLOW FAN.

2. CHARACTERS:

ITEM	DESCRIPTION
RATED VOLTAGE	48 VDC
OPERATION VOLTAGE	28.0 - 62.0 VDC
INPUT CURRENT	0.12 (MAX. 0.15) A
INPUT POWER	5.76 (MAX. 7.20) W
SPEED	5000 R.P.M.
MAX. AIR FLOW (AT ZERO STATIC PRESSURE)	1.900 (MIN. 1.710) M <sup>3</sup> /MIN 67.07 (MIN. 60.36) CFM
MAX.AIR PRESSURE (AT ZERO AIR FLOW)	18.30 (MIN. 14.82) mmH <sub>2</sub> O 0.72 (MIN. 0.583) inchH <sub>2</sub> O
ACOUSTICAL NOISE (AVG.)	49.8 (MAX 53.8) dB-A
INSULATION TYPE	UL: CLASS A

(continued)

PART NO:

DELTA MODEL: TFA0948AE

INSULATION STRENGTH	10 MEG OHM MIN. AT 500 VDC (BETWEEN FRAME AND (+) TERMINAL)
DIELECTRIC STRENGTH	5 mA MAX. AT 500 VAC 50/60 Hz ONE MINUTE, (BETWEEN FRAME AND (+) TERMINAL)
EXTERNAL COVER	OPEN TYPE
LIFE EXPECTANCE	70,000 HOURS CONTINUOUS OPERATION AT 40 °C WITH 15 ~ 65 %RH.
ROTATION	COUNTERCLOCKWISE VIEW FROM NAME PLATE SIDE
OVER CURRENT SHUT DOWN	THE CURRENT WILL SHUT DOWN WHEN LOCKING ROTOR
LEAD WIRE	LEAD WIRE: UL1007 AWG#24 RED WIRE-----(+) BLACK WIRE-----(-) LEAD WIRE: UL1061 AWG#24 BLUE WIRE----- (FOO) YELLOW WIRE----- (PWM)

- NOTES: 1. ALL READINGS ARE MEASURED AFTER STABLY WARMING UP THROUGH 10 MINUTES.  
2. THE VALUES WRITTEN IN PARENS , ( ), ARE LIMITED SPEC.  
3. ACOUSTICAL NOISE MEASURING CONDITION:

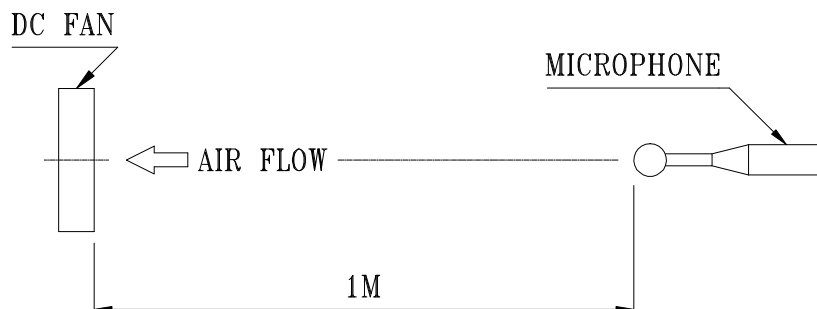

NOISE IS MEASURED AT RATED VOLTAGE IN FREE AIR IN ANECHOIC CHAMBER WITH B & K SOUND LEVEL METER WITH MICROPHONE AT A DISTANCE OF ONE METER FROM THE FAN INTAKE.

---

PART NO:

---

DELTA MODEL: TFA0948AE

---

3. MECHANICAL:

- 3-1. DIMENSIONS \_\_\_\_\_ SEE DIMENSIONS DRAWING
- 3-2. FRAME \_\_\_\_\_ PLASTIC UL: 94V-0
- 3-3. IMPELLER \_\_\_\_\_ PLASTIC UL: 94V-0
- 3-4. BEARING SYSTEM \_\_\_\_\_ TWO BALL BEARINGS
- 3-5. WEIGHT \_\_\_\_\_ 210 GRAMS

4. ENVIRONMENTAL:

- 4-1. OPERATING TEMPERATURE \_\_\_\_\_ -10 TO +70 DEGREE C
- 4-2. STORAGE TEMPERATURE \_\_\_\_\_ -40 TO +75 DEGREE C
- 4-3. OPERATING HUMIDITY \_\_\_\_\_ 5 TO 90 % RH
- 4-4. STORAGE HUMIDITY \_\_\_\_\_ 5 TO 90 % RH

5. PROTECTION:

5-1. LOCKED ROTOR PROTECTION

IMPEDANCE OF MOTOR WINDING PROTECTS MOTOR FROM FIRE IN 96 HOURS OF LOCKED ROTOR CONDITION AT THE RATED VOLTAGE.

5-2. POLARITY PROTECTION

BE CAPABLE OF WITHSTANDING IF REVERSE CONNECTION FOR POSITIVE AND NEGATIVE LEADS.

6. RE OZONE DEPLETING SUBSTANCES:

- 6-1. NO CONTAINING PBBs, PBBOs, CFCs, PBBEs, PBDPEs AND HCFCs.

7. PRODUCTION LOCATION

- 7-1. PRODUCTS WILL BE PRODUCED IN CHINA OR THAILAND OR TAIWAN.

PART NO:

DELTA MODEL: TFA0948AE

8. P & Q CURVE:

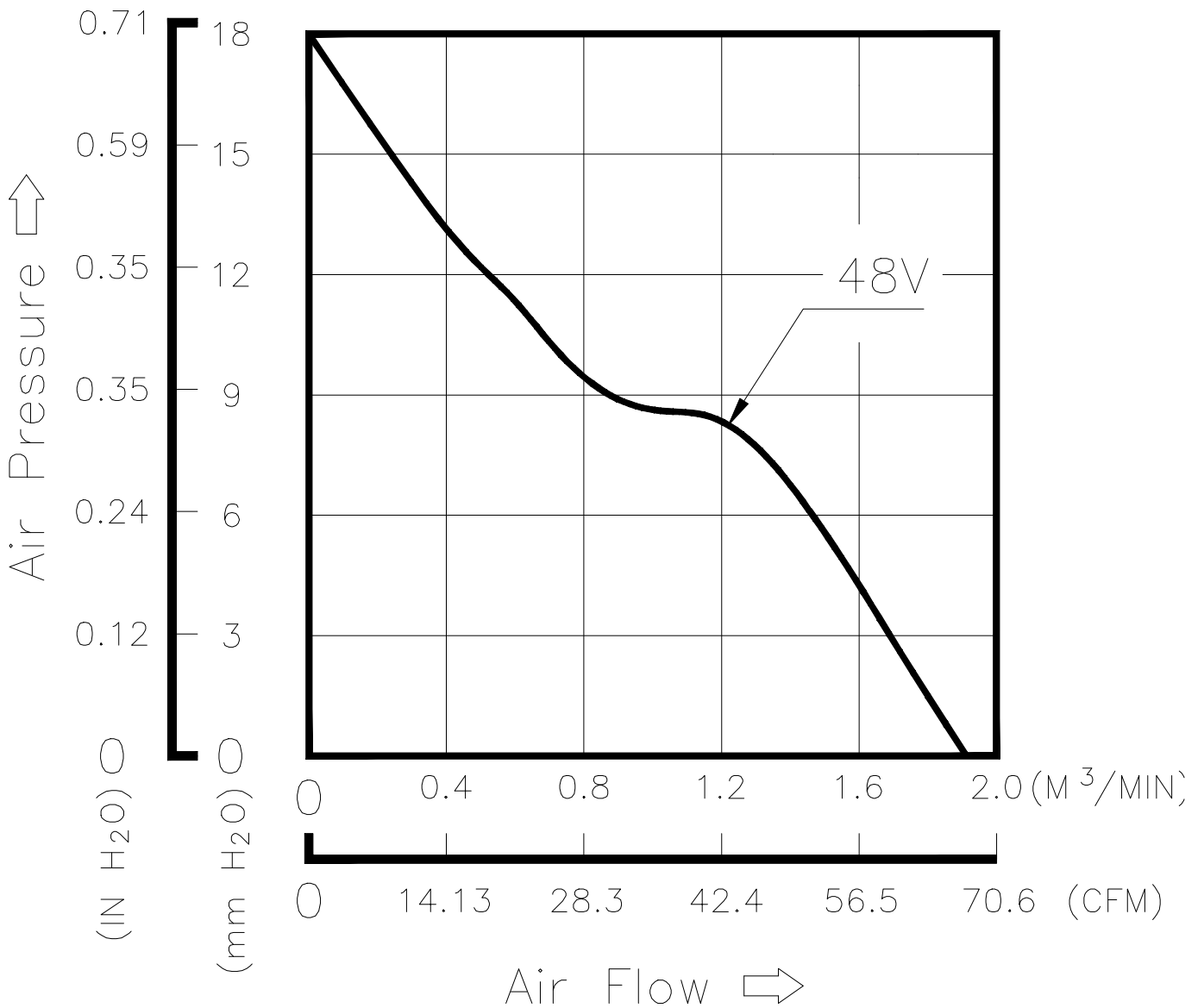

\* TEST CONDITION: INPUT VOLTAGE ——— OPERATION VOLTAGE  
TEMPERATURE ——— ROOM TEMPERATURE  
HUMIDITY ——— 65%RH

PART NO:

DELTA MODEL: TFA0948AE

9. DIMENSION DRAWING:

LABEL:

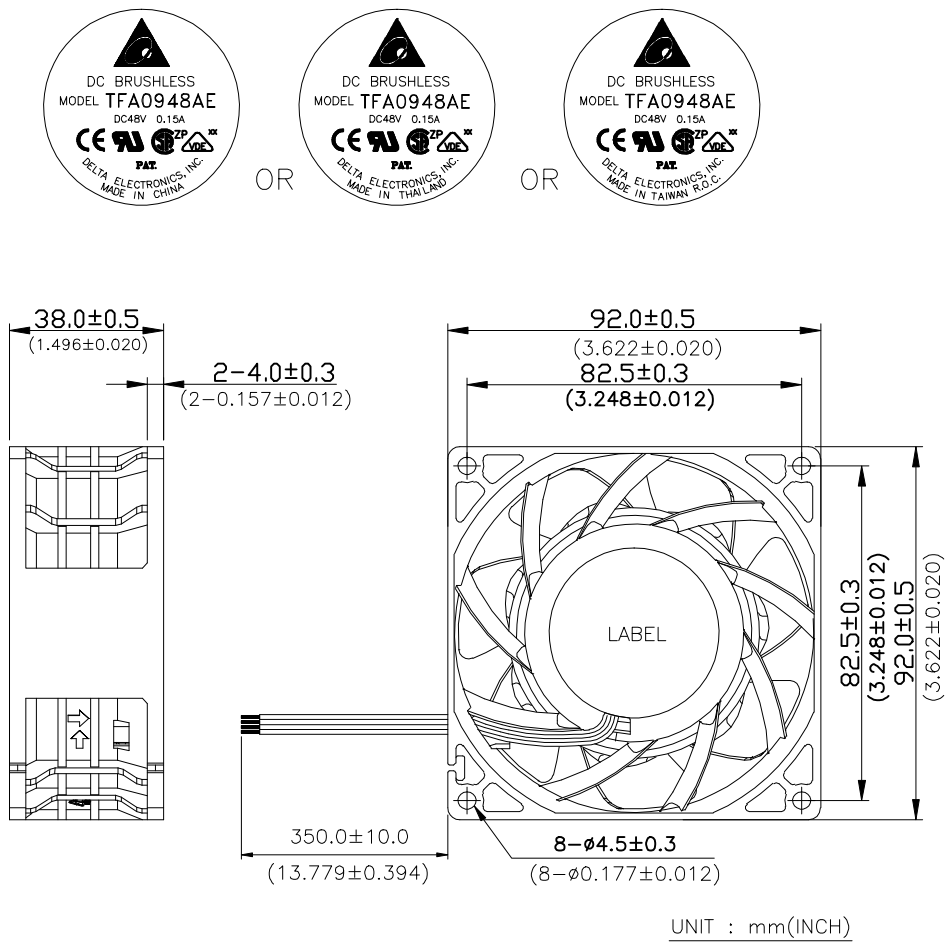

NOTES :

1. LEAD WIRE: UL1007 AWG#24  
RED WIRE-----(+)  
BLACK WIRE-----(-)  
LEAD WIRE: UL1061 AWG#24  
BLUE WIRE-----(FOO)  
YELLOW WIRE-----(PWM)

2. THIS PRODUCT IS RoHS COMPLIANT.

PART NO:

DELTA MODEL: TFA0948AE

10. FREQUENCY GENERATOR (FG) SIGNAL:

1. OUTPUT CIRCUIT - OPEN COLLECTOR MODE:

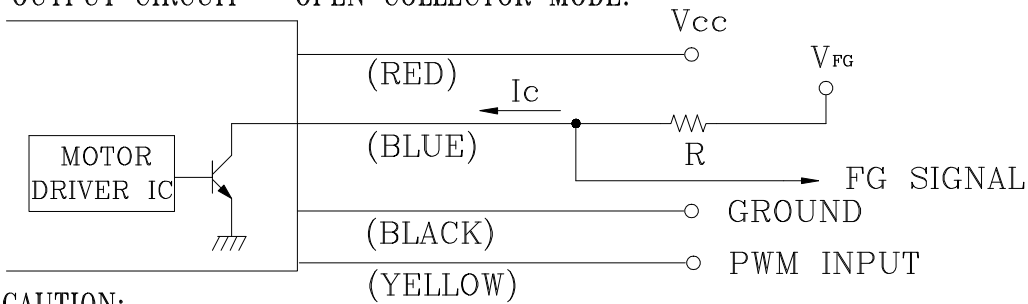

CAUTION:

THE LEAD WIRE OF FG SIGNAL CAN NOT TOUCH THE LEAD WIRE OF POSITIVE OR NEGATIVE.

2. SPECIFICATION:

$V_{CE}(\text{sat}) = 0.5\text{V MAX.}$

$V_{FG} = 62.0\text{ VDC MAX.}$

$I_c = 5\text{mA MAX.}$

$R \geq V_{FG}/I_c$

3. FREQUENCY GENERATOR WAVEFORM:

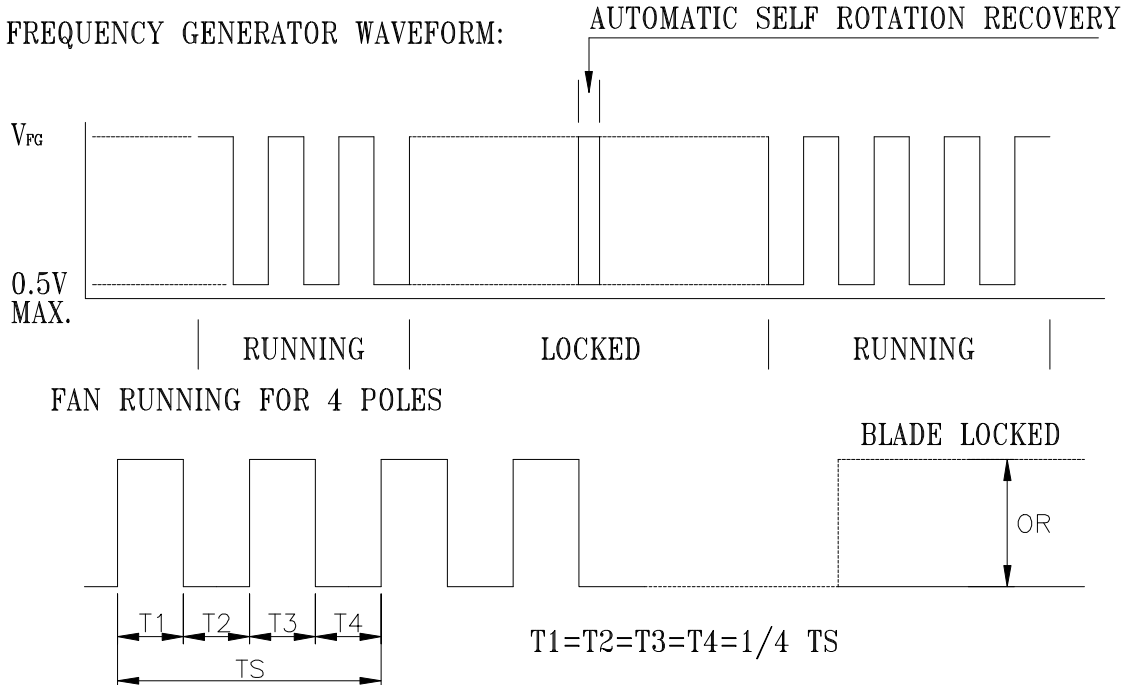

$N = \text{R.P.M}$

$TS = 60/N(\text{SEC})$

\*VOLTAGE LEVEL AFTER BLADE LOCKED

\*4 POLES

---

PART NO:

---

DELTA MODEL: TFA0948AE

---

11. PWM SYSTEM CONNECT WITH OPTOCOUPLER CONTROL ONE FAN:

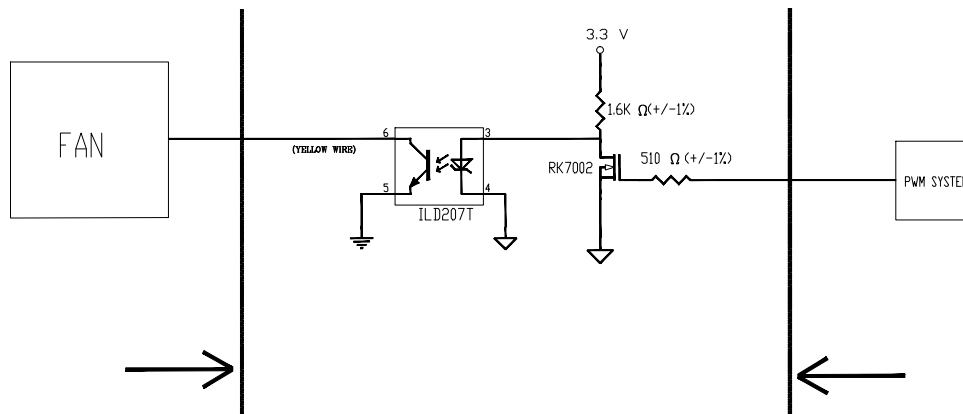

12. 40.0V~62.0V FAN SPEED KEEP IN 5000R.P.M

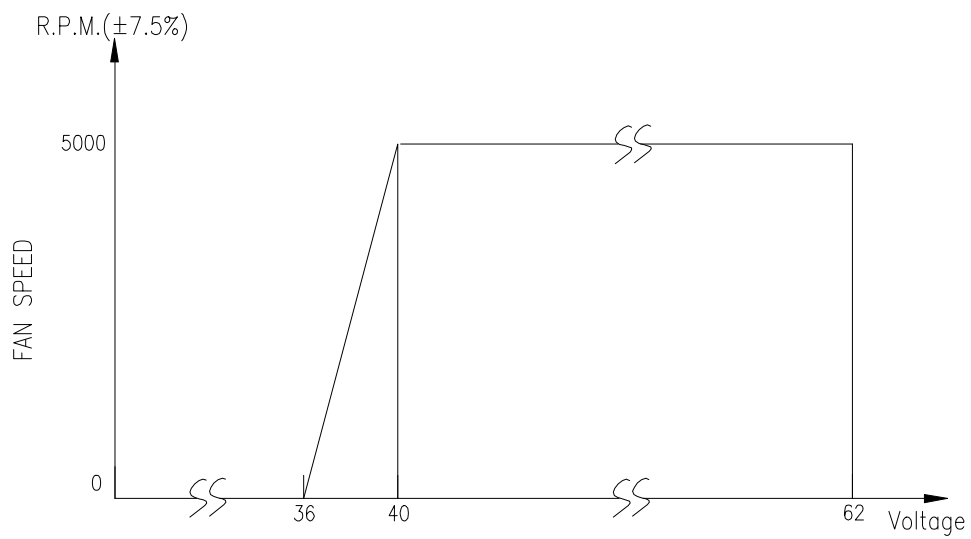

---

PART NO:

---

DELTA MODEL: TFA0948AE

---

13. PWM CONTROL SIGNAL:

SIGNAL VOLTAGE RANGE: 0~10VDC

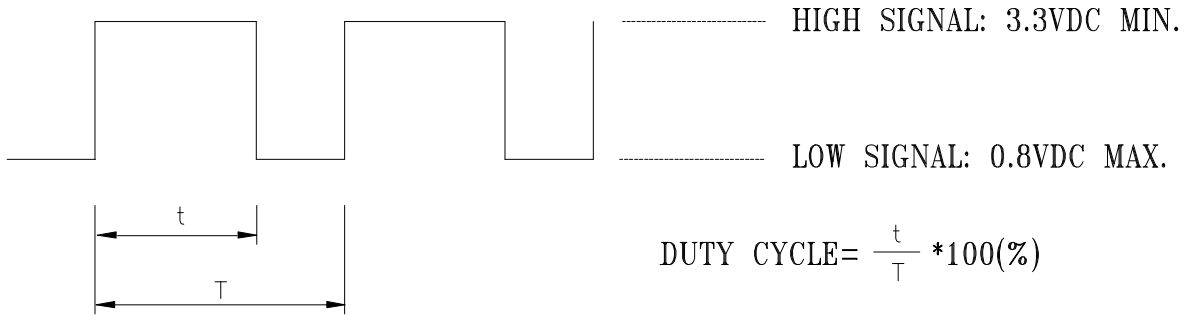

- 1.THE FREQUENCY FOR CONTROL SIGNAL OF THE FAN SHALL BE ABLE TO ACCEPT A 1KHZ TO 5KHZ.
- 2.PWM SIGNAL WITH 5VDC TTL OR CMOS LEVELS. THE PREFERRED OPERATING RANGE FOR THE PWM SIGNAL IS 5KHZ.
- 3.AT 100% DUTY CYCLE,THE ROTOR WILL BE STOPPED .
- 4.AT 0% DUTY CYCLE,THE ROTOR WILL SPIN AT MAXIMUM SPEED.
- 5.IF THE PWM CONTROL WIRE OPEN,THE ROTOR WILL BE STOPPED.
- 6.WHEN THE ROTOR IS HALTED , IT WILL BE ABLE START FROM A DEAD STOP MORE THAN 80% DUTY CYCLE.

14. SPEED VS PWM CONTROL SIGNAL:(DC:40V FREQUENCY:5KHZ PWM:5V)

NOKIA SPEC DUTY CYCLE (%)	SPEED R.P.M. (REF.)	CURRENT (A)
0	5000 ± 10%	<b>0.12</b>
48	2750 ± 10%	<b>0.05</b>
100	0	<b>0.01</b>



## ***Application Notice***

- 1. Delta will not guarantee the performance of the products if the application condition falls outside the parameters set forth in the specification.**
- 2. A written request should be submitted to Delta prior to approval if deviation from this specification is required.**
- 3. Please exercise caution when handling fans. Damage may be caused when pressure is applied to the impeller, if the fans are handled by the lead wires, or if the fan was hard-dropped to the production floor.**
- 4. Except as pertains to some special designs, there is no guarantee that the products will be free from any such safety problems or failures as caused by the introduction of powder, droplets of water or encroachment of insect into the hub.**
- 5. The above-mentioned conditions are representative of some unique examples and viewed as the first point of reference prior to all other information.**
- 6. It is very important to establish the correct polarity before connecting the fan to the power source. Positive (+) and Negative (-). Damage may be caused to the fans if connection is with reverse polarity, if there is no foolproof method to protect against such error specifically mentioned in this spec.**
- 7. Delta fans without special protection are not suitable where any corrosive fluids are introduced to their environment.**
- 8. Please ensure all fans are stored according to the storage temperature limits specified. Do not store fans in a high humidity environment. We highly recommend performance testing is conducted before shipping, if the fans have been stored over 6 months.**
- 9. Not all fans are provided with the Lock Rotor Protection feature. If you impair the rotation of the impeller for the fans that do not have this function, the performance of those fans will lead to failure.**
- 10. Please be cautious when mounting the fan. Incorrect mounting of fans may cause excess resonance, vibration and subsequent noise.**
- 11. It is important to consider safety when testing the fans. A suitable fan guard should be fitted to the fan to guard against any potential for personal injury.**
- 12. Except where specifically stated, all tests are carried out at room (ambient) temperature and relative humidity conditions of 25°C, 65% RH. The test value is only for fan performance itself.**
- 13. Be certain to connect an “ 4.7 $\mu$ F or greater” capacitor to the fan externally when the application calls for using multiple fans in parallel, to avoid any unstable power.**