

DKSV052

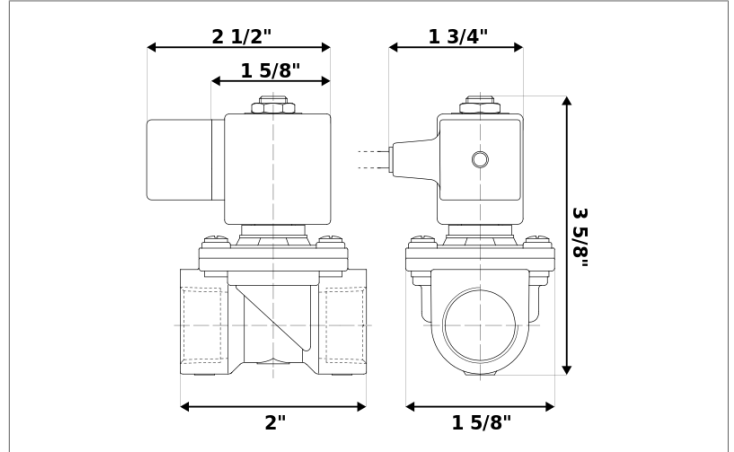

Normally closed, pilot operated, 2-way solenoid valve with brass body and 3/8" connections



Valve	
Pipe size:	3/8" NPT
Operating pressure:	2–300 psi
Flow coefficient:	1.8 Cv
Media temperature:	15–280 °F
Ambient temperature:	-5–140 °F
Suggested usage:	Air, inert gas, synthetic oils, water
Operation:	2-way, normally closed solenoid valve
Mechanism:	Pilot operated
Manual override:	No
Pipe gender:	Female
Orifice size:	3/8"
Media viscosity:	12 cSt

Electrical	
Power:	24 V ac
Connection:	6 ft. power cord
Holding:	17 VA
Inrush:	25 VA
Voltage tolerances:	+10% -15%
Coil inner diameter:	1/2"
Coil molding:	Polyethylene (PET)
Coil rating:	-5–355 °F (Class H)
Duty cycle:	Continuous, 100% ED
Enclosure:	NEMA 4, IP65

Materials	
Body:	Brass
Seal:	Fluoroelastomer rubber (FKM)
Orifice:	Brass
Core tube:	Stainless steel 300
Fixed core:	Stainless steel 400
Plunger:	Stainless steel 400
Spring:	Stainless steel 300
Shading ring:	Copper

Spare parts	
REPAIR KIT	COIL/CONNECTOR
RK-E0V1	C-B32
	
<ul style="list-style-type: none"> • Diaphragm • O-ring • Plunger 	<ul style="list-style-type: none"> • 24 V ac electrical coil • 6 ft. power cord