

## L0805C5R6MSMST

Aliases (L0805C5R6MSMST)

Obsolete

KEMET, L-SMS, Commercial Grade, 5.6 uH, 20%

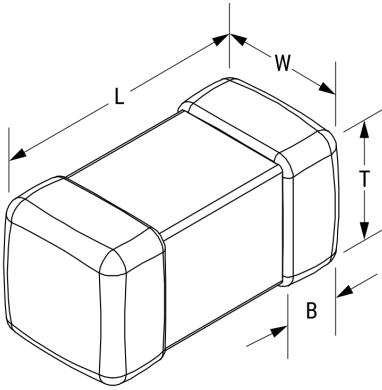

Click [here](#) for the 3D model.

### Dimensions

Chip Size	0805
L	2mm +0.3/-0.1mm
W	1.25mm +/-0.2mm
T	1.25mm +/-0.2mm
LL	0.5mm +/-0.2mm
B	0.5mm +/-0.2mm

### Packaging Specifications

Packaging	T&R
Packaging Quantity	2000

### General Information

Series	L-SMS
Style	SMD Chip
Description	Shielded, Surface Mount Inductor
Features	Standard Type
RoHS	Yes
Core	Ceramic
Winding Type	Multilayer
Notes	Suggested Replacement - <a href="https://www.chilisin.com/en-global/Inductor/Product/BSCL_201212/BSCL002012125R6M00">https://www.chilisin.com/en-global/Inductor/Product/BSCL_201212/BSCL002012125R6M00</a> .

### Specifications

Inductance	5.6 uH
Inductance Tolerance	20%
Temperature Range	-40/+85°C
Current	15 mAmps (MAX)
DC Resistance	0.9 Ohms
Quality Factor	50 at 4 MHz
Self-Resonant Frequency	32 MHz