

12V, 15V and 24V 20A Buffer (Hold-Up) Modules

<https://product.tdk.com/en/power/zbm>
www.emea.lambda.tdk.com/zbm



The ZBM20 20A buffer modules are ideal for providing short term hold-up or peak power for loads powered by 12V, 15V or 24Vdc output AC-DC power supplies. During normal operation, energy is stored in the ZBM20's electrolytic capacitors. When the AC power is interrupted for a short period of time, the ZBM20 continues to power the load, allowing equipment to shutdown in a safe and controlled manner. The ZBM20 can be set to fixed or variable buffer mode. In fixed mode it will provide power when the input voltage drops to below a preset level, in variable mode (24V model only) when the input decreases by 1V. Multiple buffer modules can be paralleled for additional hold-up time. Product status can be accessed remotely via a DC OK relay. The output voltage can also be inhibited to avoid an unsafe discharge of the stored energy.

Features	Benefits
• Provides 380ms Additional Hold-Up Time at Max Buffer Power	• Avoids Loss of Data During AC Power Interruptions
• Utilizes Electrolytic Capacitors to Store Energy	• No Batteries to Service or Maintain
• Five Year Warranty	• Lower Cost of Ownership
• Parallel Capable	• Hold-Up Time Can Be Extended
• Output Remote On/Off Function	• Avoids Unsafe Discharge of Stored Energy

Model Selector				
Model	Output Voltage Fixed Mode (V) (1)	Output Voltage Dynamic Mode (V) (1)	Maximum Current (A)	Average Buffer Power (W)
ZBM20-12	11	-	20	220
ZBM20-15	13.8	-	20	276
ZBM20-24	22.4	Vin-1	20	448

Specifications				
Model		ZBM20-12	ZBM20-15	ZBM20-24
Input				
Input Voltage range	Vdc	11.5 - 14.4	14.4 - 18	Fixed Mode: 23 - 30 Vin-1 Mode: 24 - 30
Input Current (Typical)	A	Charging Mode: 0.8, Ready Mode: 0.2		
Charging Time (Typical)	s	40		
Hold Up Time (Typical)	ms	380		
Conducted & Radiated EMI	-	EN55032-B CISPR32-B		
Immunity	-	See immunity table		
Safety Agency Certifications	-	IEC/UL/CSA/EN62368-1, CE Mark (LVD, EMC and RoHS)		
Immunity				
Test	Standard	Test Level	Criteria	Notes
ESD	EN61000-4-2	4	A	15kV air, 8kV contact
Radiated Susceptibility	EN61000-4-3	3	A	
Electrical Fast Transient Burst	EN61000-4-4	1-3	A	Signal pin to FG Lvl 1
Surge	EN61000-4-5	1-2	A	Common mode only Lvl 2 Signal pin to FG Lvl 1
Conducted Susceptibility	EN61000-4-6	3	A	-
Output				
Buffer Voltage Tolerance (Load > 5%)	%	Fixed Mode: ± 2 , Dynamic Mode: +3 to -4 (24V model only)		
Switching Frequency (Typical)	kHz	Buck Converter: 100, Boost Converter: 65		
Ripple & Noise	mV	<160		<240
Minimum Load	-	No minimum load required		
Overcurrent Protection	%	>105 of buffer current		
Input Overvoltage Protection	-	Yes		
Overtemperature Protection	-	No		
Remote On/Off	-	Yes		
DC OK Relay	-	Photo MOS relay closed when DC is okay. (30V 0.2A)		
Status Signals	-	Photocoupled signals indicating fully charged and discharging modes		
Indicators	-	Green LED is off when bulk capacitor voltage is below SELV level		
Parallel Operation	-	Possible, see installation manual		
Series Operation	-	Not possible		
Environmental				
Operating Temperature	°C	-25 to +70		
Storage Temperature	°C	-25 to +85		
Humidity (non condensing)	%RH	Operating: 30 - 90, storage: 10 - 90		
Cooling	-	Convection		
Altitude	m	5,000		
Withstand Voltage (For 1 minute)	Vac	Input and output to ground 500		
Isolation Resistance	MΩ	>100 at 25°C, 70%RH & 500VDC (input and output to ground)		
Vibration (Non Operating)	-	10 - 55Hz (sweep for 1 min) 19.6m/s ² (constant X, Y, Z axis for 1 hour each)		
Shock (In packaging)	m/s ²	< 196.1		
Other				
Weight (Typ)	g	550		
Size (LxWxH)	mm	175 x 85 x 57		
Size (LxWxH)	Inches	6.89 x 3.35 x 2.24		
Connectors		CN1 & 2: JST B6P-VH, CN3: JST B6B-XH-A		
MTBF - Telcordia TR-332 issue 5 (25°C)	Hours	1,960,742		
Warranty	yrs	5		

Notes

See website for detailed specifications, test methods and installation manual

(1) ZBM20-24 Fixed and VIN-1 mode is switch selectable using SW1

Buffer Time Versus Buffer Current

ZBM20-12 :
Buffer time : 0 – 2 seconds

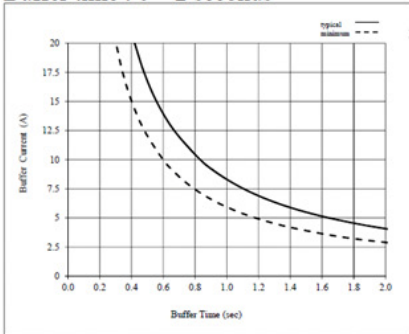

NOTE : Ta=25°C and initial capacitance.

ZBM20-15 :
Buffer time : 0 – 2 seconds

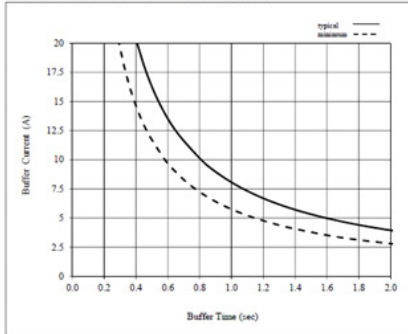

NOTE : Ta=25°C and initial capacitance.

ZBM20-24 :
Buffer time : 0 – 2 seconds

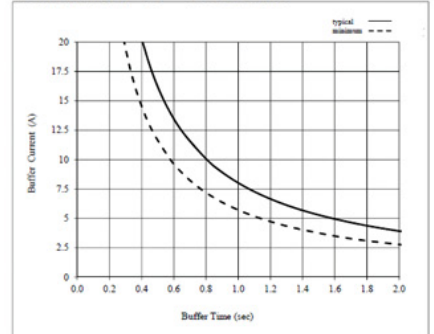

NOTE : Ta=25°C and initial capacitance.

Block Diagram

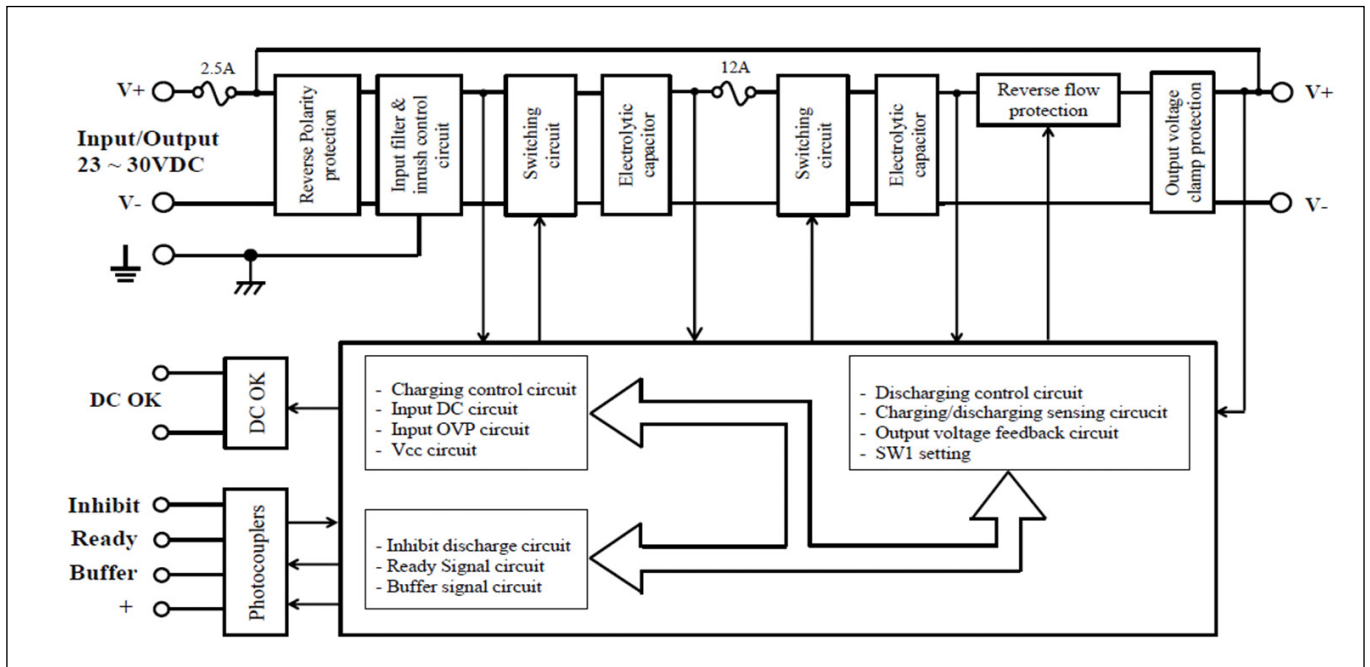

Timing Diagram

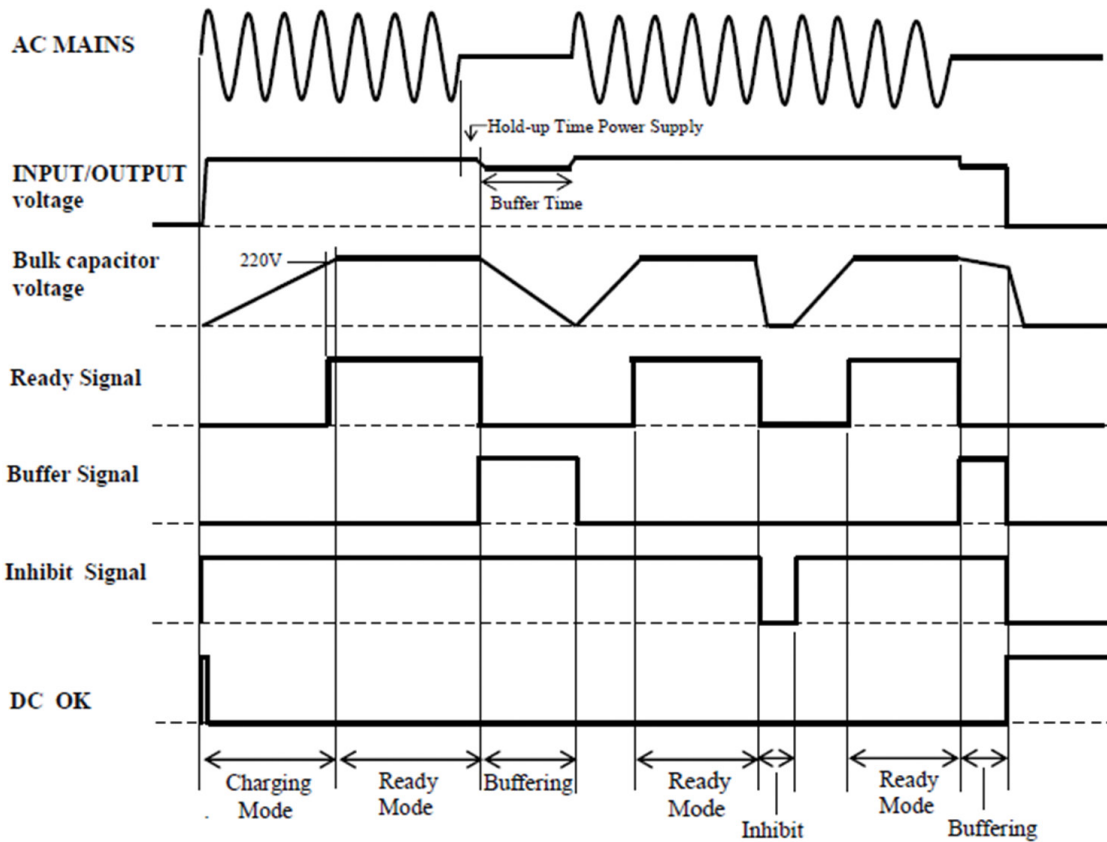

Mechanical Specification

Outline Drawing ZBM20

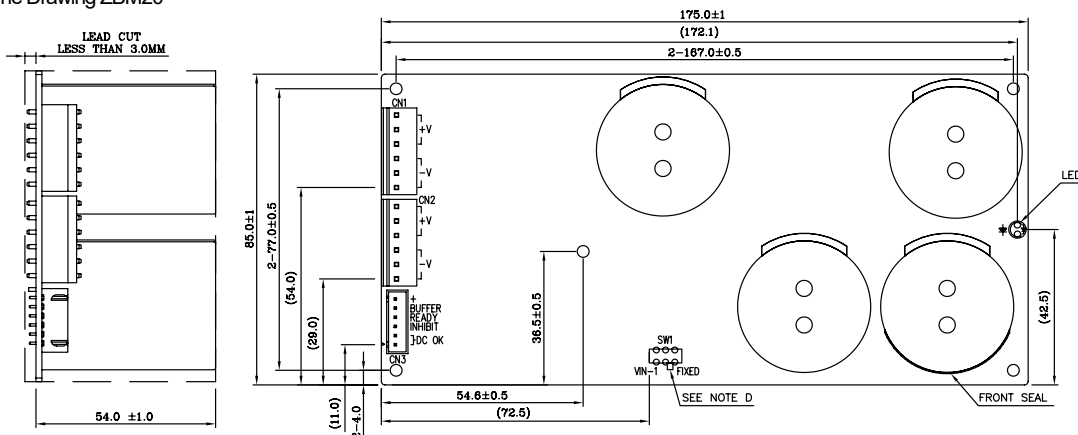

CONNECTORS USED :

PART DESCRIPTION	PART NAME	MANUFACT.	QTY
PIN HEADER (CN1 & CN2)	B6P-VH(LF)(SN)	J.S.T.	2
PIN HEADER (CN3)	B6B-XH-A(LF)(SN)	J.S.T.	1

MATCHING HOUSINGS, PINS & TOOL (NOT INCLUDED WITH THE PRODUCT):

PART DESCRIPTION	PART NAME	MANUFACT.	QTY
SOCKET HOUSING (CN1 & CN2)	VHR-6N	J.S.T.	2
SOCKET HOUSING (CN3)	XHP-6	J.S.T.	1
TERMINAL PINS	SVH-41T-P1.1	J.S.T.	12
TERMINAL PINS	SXH-002T-P0.6	J.S.T.	6

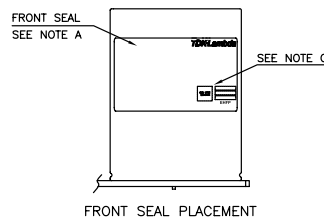

NOTES

- MODEL NAME, INPUT VOLTAGE RANGE, NOMINAL OUTPUT VOLTAGE, MAXIMUM OUTPUT CURRENT, BUFFER TIME & COUNTRY OF MANUFACTURE ARE SHOWN IN ACCORDANCE WITH THE SPECIFICATION.
- 5- ϕ 3.2 HOLES ARE FOR CUSTOMER'S CHASSIS MOUNTING HOLE.
- BARCODE, SERIAL NO. ARE SHOWN HERE.
- SWITCH IS SELECTED TO FIXED MODE BEFORE SHIPMENT. (SWITCH IS FOR 24V ONLY).



TDK-Lambda France SAS

Tel: +33 1 60 12 71 65
france@fr.tdk-lambda.com
www.emea.lambda.tdk.com/fr



Italy Sales Office

Tel: +39 02 61 29 38 63
info.italia@it.tdk-lambda.com
www.emea.lambda.tdk.com/it



Netherlands

info@nl.tdk-lambda.com
www.emea.lambda.tdk.com/nl



TDK-Lambda Germany GmbH

Tel: +49 7841 666 0
info.germany@de.tdk-lambda.com
www.emea.lambda.tdk.com/de



Austria Sales Office

Tel: +43 2256 655 84
info@at.tdk-lambda.com
www.emea.lambda.tdk.com/at



Switzerland Sales Office

Tel: +41 44 850 53 53
info@ch.tdk-lambda.com
www.emea.lambda.tdk.com/ch



Nordic Sales Office

Tel: +45 8853 8086
info@dk.tdk-lambda.com
www.emea.lambda.tdk.com/dk



TDK-Lambda UK Ltd.

Tel: +44 (0) 12 71 85 66 66
powersolutions@uk.tdk-lambda.com
www.emea.lambda.tdk.com/uk



TDK-Lambda Ltd.

Tel: +9 723 902 4333
info@tdk-lambda.co.il
www.emea.lambda.tdk.com/il



C.I.S.

Commercial Support:

Tel: +7 (495) 665 2627

Technical Support:

Tel: +7 (812) 658 0463

info@tdk-lambda.ru

www.emea.lambda.tdk.com/ru



TDK-Lambda Americas

Tel: +1 800-LAMBDA-4 or 1-800-526-2324
powersolutions@us.tdk-lambda.com
www.us.lambda.tdk.com



TDK Electronics do Brasil Ltda

Tel: +55 11 3289-9599
sales.br@tdk-electronics.tdk.com
www.tdk-electronics.tdk.com/en



TDK-Lambda Corporation

Tel: +81-3-6778-1113
www.jp.lambda.tdk.com



TDK-Lambda (China) Electronics Co. Ltd.

Tel: +86 21 6485-0777
powersolutions@cn.tdk-lambda.com
www.lambda.tdk.com.cn



TDK-Lambda Singapore Pte Ltd.

Tel: +65 6251 7211
tis.mkt@sg.tdk-lambda.com
www.sg.lambda.tdk.com



TDK India Private Limited, Power Supply Division

Tel: +91 80 4039-0660
mathew.philip@in.tdk-lambda.com
www.sg.lambda.tdk.com

