

**Contact Detail:  
541-Wire Wrap .026x.024(0.66x0.61) - Tail LG.=.620(15.75)**

THIS IS A C.A.D. GENERATED DRAWING  
DO NOT MAKE MANUAL REVISIONS TO MASTER.



ISSUE NUMBER

ORIGINAL

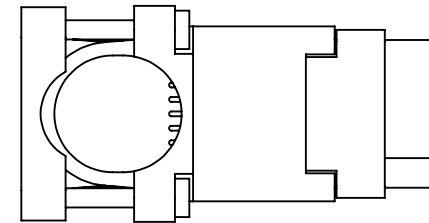
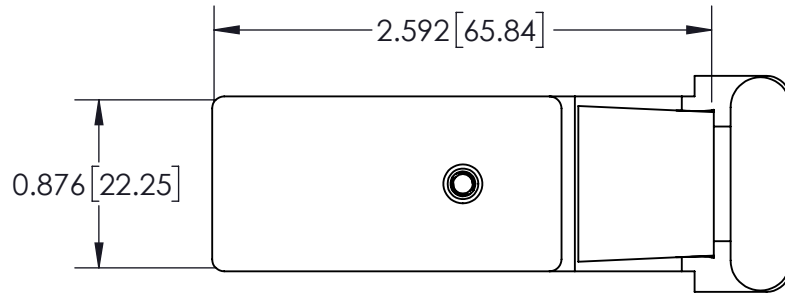

**Features**

- UL Recognized
- .150 (3.81) Contact Spacing x .130 (3.30) or .150 (3.81) Row Spacing with Staggered Grid
- Plug and Receptacle in 20, 38, 56, 90 or 120 Contact Sizes
- Edacon Hermaphroditic Contact Mating Design
- Contact Termination Options Include: Crimp, P.C. Tail, Wire Hole and Wire Wrap
- Mating and Unmating Simplified with use of Actuating Screws
- Optional Covers with Side or Top Entry Cable Clamp in Plastic or Metal Material Available for All Connector Sizes
- Versatile Metal Cover Design Permits Assembly and Disassembly after Cabling is Complete plus Cable Entry Style Flexibility
- Actuating Screws, Locknuts, Polarizing Hardware, Covers and Contacts Suitable for either Plug or Receptacle
- Polarizing Hardware Adjustable for 288 Mating Combinations
- Tools Available for Contact Installation, Removal and Crimping and Polarizing Changes

**Specifications**

- Insulator Material: Diallyl Phthalate or Thermo plastic Polyester, UL94V-0, Colour: Green, or Polycarbonate, Colour: Grey
- Contact Material: Phosphor Bronze Alloy CA-510
- Contact Plating: Gold over Nickel for Entire Contact
- Cover Material: Polycarbonate, Colour: Green, or Die-Cast Zinc, Finished with Grey Enamel Paint
- Current Rating: 8.5 Amperes
- Contact Resistance: 10 Milliohms Maximum
- Dielectric Withstanding Voltage: 2000 V AC rms at Sea Level
- Insulation Resistance: 5000 Megohms Minimum
- Operating Temperature: -65 to +125 Degrees C
- Insertion and Withdrawal Force: 2 to 16 oz (0.56 to 4.45 N) per Contact Position

**See Accompanying Pages for:**  
 - PC Tail Layout  
 - Cutout Panel Details  
 - Cover Details

516 Assembly

Part Number: 516-056-541-246



EDAC INC  
TORONTO, ONTARIO  
CANADA

YOUR CONNECTION TO QUALITY & SERVICE

THESE DRAWINGS AND SPECIFICATIONS ARE THE PROPERTY OF EDAC INC. AND SHALL NOT BE REPRODUCED, OR COPIED OR USED AS THE BASIS FOR THE MANUFACTURE OR SALE OF APPARATUS WITHOUT WRITTEN PERMISSION.

ACAD REFERENCE NO. 516 Assembly

DRAWN: J.LEE DATE: JUNE 18, 2009

CHECKED: DATE:

SCALE: 1:1 SHEET 1 OF 4

DRAWING NUMBER ISSUE

516 Assembly

1

THIS IS A C.A.D. GENERATED DRAWING  
DO NOT MAKE MANUAL REVISIONS TO MASTER.



ISSUE NUMBER

ORIGINAL

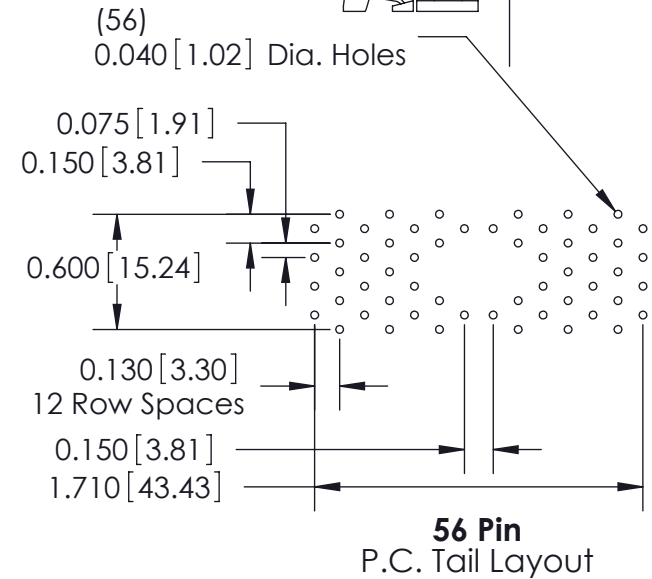
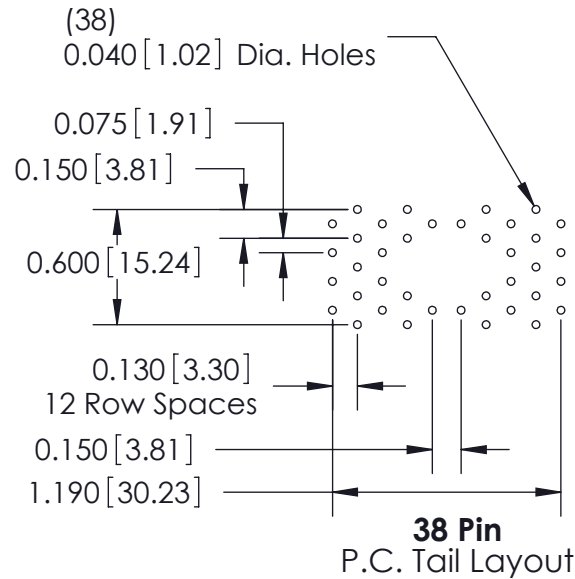

516 Assembly  
P.C. Tail Layout Details



EDAC INC  
TORONTO, ONTARIO  
CANADA

YOUR CONNECTION TO QUALITY & SERVICE

THESE DRAWINGS AND SPECIFICATIONS  
ARE THE PROPERTY OF EDAC INC. AND  
SHALL NOT BE REPRODUCED, OR COPIED  
OR USED AS THE BASIS FOR THE  
MANUFACTURE OR SALE OF APPARATUS  
WITHOUT WRITTEN PERMISSION.

ACAD REFERENCE NO. 516 Assembly

DRAWN: J.LEE DATE: JUNE 18, 2009

CHECKED: DATE:

SCALE: 1:1 SHEET 2 OF 4

DRAWING NUMBER ISSUE

516 Assembly

1



	Dimension A	Dimension B	Dimension C	Dimension D	Dimension E	Dimension F	Dimension G
20 Pin	0.104 [2.64]	0.640 [16.26]	0.410 [10.41]	0.960 [24.38]	1.126 [28.60]	1.270 [32.26]	R0.130 [R3.30]
38 Pin	0.136 [3.45]	0.816 [20.73]	0.468 [11.89]	1.420 [36.07]	1.688 [42.88]	1.958 [49.73]	R0.130 [R3.30]
56 Pin	0.136 [3.45]	0.816 [20.73]	0.468 [11.89]	1.940 [49.28]	2.280 [57.91]	2.550 [64.77]	R0.130 [R3.30]
90 Pin	0.136 [3.45]	1.120 [28.45]	0.765 [19.43]	2.050 [52.07]	2.282 [57.96]	2.675 [67.95]	R0.130 [R3.30]
120 Pin	0.136 [3.45]	1.420 [36.07]	0.875 [22.23]	2.050 [52.07]	2.375 [60.33]	2.675 [67.95]	R0.130 [R3.30]

<b>516 Assembly</b> <b>Cut-Out Panel Detail</b>		ACAD REFERENCE NO. 516 Assembly	
		DRAWN: J.LEE	DATE: JUNE 18, 2009
 EDAC INC TORONTO, ONTARIO CANADA YOUR CONNECTION TO QUALITY & SERVICE		CHECKED:	DATE:
		SCALE:	SHEET 3 OF 4
THESE DRAWINGS AND SPECIFICATIONS ARE THE PROPERTY OF EDAC INC. AND SHALL NOT BE REPRODUCED, OR COPIED OR USED AS THE BASIS FOR THE MANUFACTURE OR SALE OF APPARATUS WITHOUT WRITTEN PERMISSION.		DRAWING NUMBER	ISSUE
		516 Assembly	1

THIS IS A C.A.D. GENERATED DRAWING  
DO NOT MAKE MANUAL REVISIONS TO MASTER.



ISSUE NUMBER  
ORIGINAL

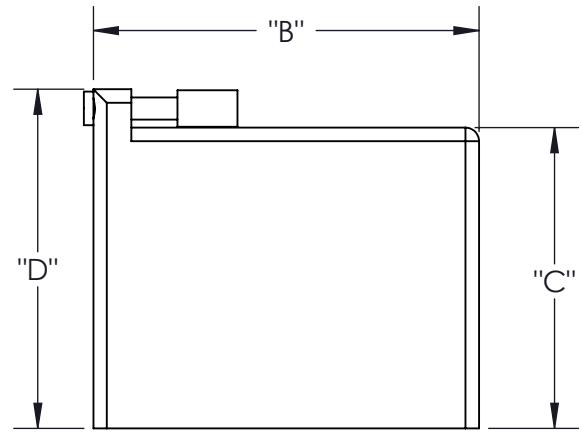

Top Entry

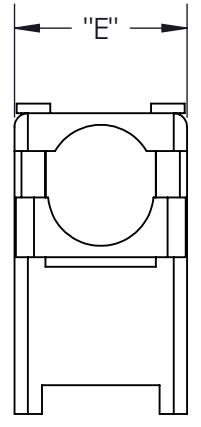

Side Entry

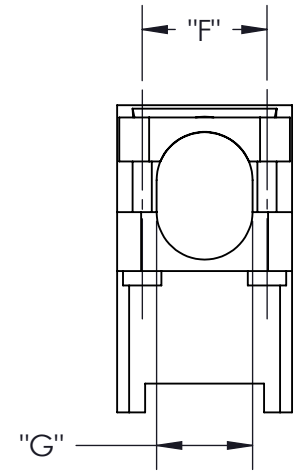

Standard Clamp

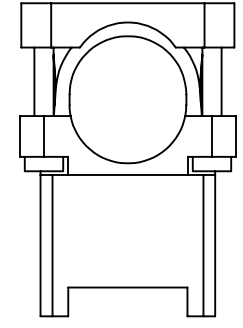

Large Clamp

Cover for Connector	Cover Material	Clamp Size	"A"	"B"	"C"	"D"	"E"	"F"	"G"
20 Pin	Plastic	Standard	1.605 (40.77)	1.325 (33.66)	0.906 (23.01)	1.190 (30.23)	0.715 (18.16)	0.450 (11.43)	0.450 (11.43)
20 Pin	Metal	Standard	1.539 (39.09)	1.325 (33.66)	0.906 (23.01)	1.120 (28.45)	0.686 (17.42)	0.446 (11.33)	0.490 (12.45)
38 Pin	Plastic	Standard	2.460 (62.48)	2.010 (51.05)	1.530 (38.86)	1.985 (50.42)	0.910 (23.11)	0.650 (16.51)	0.500 (12.70)
38 Pin	Plastic	Large	2.460 (62.48)	2.010 (51.05)	1.530 (38.86)	1.985 (50.42)	1.110 (28.19)	0.650 (16.51)	0.608 (15.44)
38 Pin	Metal	Standard	2.206 (56.03)	2.006 (50.95)	1.566 (39.78)	1.766 (44.86)	0.875 (22.23)	0.720 (18.29)	0.575 (14.61)
56 Pin	Plastic	Standard	2.602 (66.09)	2.602 (66.09)	1.530 (38.86)	1.985 (50.42)	0.910 (23.11)	0.650 (16.51)	0.500 (12.70)
56 Pin	Plastic	Large	2.602 (66.09)	2.602 (66.09)	1.530 (38.86)	1.985 (50.42)	1.110 (28.19)	0.650 (16.51)	0.608 (15.44)
56 Pin	Metal	Standard	2.602 (66.09)	2.602 (66.09)	1.566 (39.78)	1.766 (44.86)	0.875 (22.23)	0.720 (18.29)	0.575 (14.61)
90 Pin	Plastic	Standard	2.718 (69.04)	2.718 (69.04)	1.775 (45.09)	2.181 (55.40)	1.250 (31.75)	0.800 (20.32)	0.800 (20.32)
90 Pin	Metal	Standard	2.718 (69.04)	2.718 (69.04)	1.775 (45.09)	2.175 (55.25)	1.234 (31.34)	0.880 (22.35)	0.900 (22.86)
120 Pin	Plastic	Standard	2.750 (69.85)	2.750 (69.85)	2.020 (51.31)	2.426 (61.62)	1.530 (38.86)	0.800 (20.32)	1.080 (27.43)
120 Pin	Metal	Standard	2.750 (69.85)	2.750 (69.85)	2.020 (51.31)	2.445 (62.10)	1.531 (38.89)	0.890 (22.61)	1.080 (27.43)

516 Assembly  
Cut-Out Panel Detail

**EDAC**  
EDAC INC  
TORONTO, ONTARIO  
CANADA  
YOUR CONNECTION TO QUALITY & SERVICE

THESE DRAWINGS AND SPECIFICATIONS ARE THE PROPERTY OF EDAC INC. AND SHALL NOT BE REPRODUCED, OR COPIED OR USED AS THE BASIS FOR THE MANUFACTURE OR SALE OF APPARATUS WITHOUT WRITTEN PERMISSION.

ACAD REFERENCE NO. 516 Assembly	
DRAWN: J.LEE	DATE: JUNE 18, 2009
CHECKED:	DATE:
SCALE:	SHEET 4 OF 4
DRAWING NUMBER 516 Assembly	ISSUE 1