



# TAOGLAS®



# Datasheet

## GGBLA.125.A

### Description:

GGBLA.125.A – GPS L1/L2/L5/L6, GLONASS, BeiDou Ceramic Loop Antenna for cm-Level with RTK

### Features:

Low Profile, Small Footprint Embedded Loop Antenna  
Centimeter-level accuracy achievable with RTK Systems

- GPS/QZSS (L1/L2)
- GPS/QZSS/IRNSS (L5)
- Galileo (E1/E5a/E5b/E6)
- GLONASS (G1/G2/G3)
- BeiDou (B1/B2a/B2b)

Tuned for SMD Mounting on 80x40mm Ground Plane

High efficiency, up to 80%

Dimensions: 10 \* 3.2 \* 1.5 mm

RoHS & Reach Compliant

1.	Introduction	3
2.	Specifications	4
3.	Antenna Characteristics	6
4.	2D Radiation Patterns	8
5.	3D Radiation Patterns	10
6.	Field Test Results	11
7.	Mechanical Drawing	12
8.	Packaging	17
<hr/>		
	Changelog	18

Taoglas makes no warranties based on the accuracy or completeness of the contents of this document and reserves the right to make changes to specifications and product descriptions at any time without notice. Taoglas reserves all rights to this document and the information contained herein. Reproduction, use or disclosure to third parties without express permission is strictly prohibited.



# 1. Introduction



The Taoglas GGBLA.125.A is a unique embedded ceramic miniature loop antenna designed for GPS L1,L2, L5 and L6 applications. It also covers all GNSS requirements including GLONASS (L1PT, L1CR, L5R), Galileo (E1, E2, E5a, E5b, E6), BeiDou (B1, B2, B3), IRNSS(L5) & QZSS Frequencies.

With dimensions of just 10 x 3.2 x 1.5mm, a keep out area of just 15 x 9.8mm on the PCB, the GGBLA.125 makes an ideal multi band GNSS antenna solution for compact high precision automotive navigation or asset tracking devices where board space is at a premium. An SMD component, delivered on tape and reel, the middle edge-of-board mounted antenna, has an omnidirectional radiation pattern that allows customers to use an omnidirectional antenna in devices where orientation of the product may be unknown, or subject to frequent movement.

The wide bandwidth maintains high efficiency and reception stability on all GNSS bands from 1164MHz to 1602MHz. The GGBLA.125 exhibits efficiencies of between 60% and 80%, depending on the band used. With a peak gain of 2.6-3.6dBi, the gain performance compares with the ranges of much larger patch antennas of up to 18 x 18mm. Based on the loop antenna electrical effect, this antenna works best when placed in the center of the edge of the board.

Typical Applications Include:

- :: Navigation & RTK Systems
- :: Autonomous Vehicles
- :: IOT Devices
- :: Transportation, Marine & Agriculture
- :: UAVs and Robotics
- :: Location based applications

As with all onboard SMD antennas, care must be taken to ensure the device ground-plane layout and antenna matching has been done correctly. At any of our global design and test facilities, Taoglas can offer professional Gerber review, transmission line design, general integration support and final matching services of the GGBLA.125.A on your device board.

Contact your regional Taoglas customer support team for more information about this product, its' integration or immediate support.

## 2. Specifications

GNSS Frequency Bands Covered						
GPS	L1	L2	L5			
	■	■	■			
GLONASS	G1	G2	G3			
	■	■	■			
Galileo	E1	E5a	E5b	E6		
	■	■	■	■		
BeiDou	B1	B2a	B2b	B3		
	■	■	■	■		
QZSS (Regional)	L1	L2C	L5	L6		
	■	■	■	■		
IRNSS (Regional)	L5					
	■					
SBAS	L1/E1/B1	L5/B2a/E5a	G1	G2	G3	
	■	■	■	■	■	

\*SBAS systems: WASS(L1/L5), EGNOS(E1/E5a), SDGM(G1/G2/G3), SNAS(B1/B2a), GAGAN(L1/L5), QZSS(L1/L5), KAZZ(L1/L5).

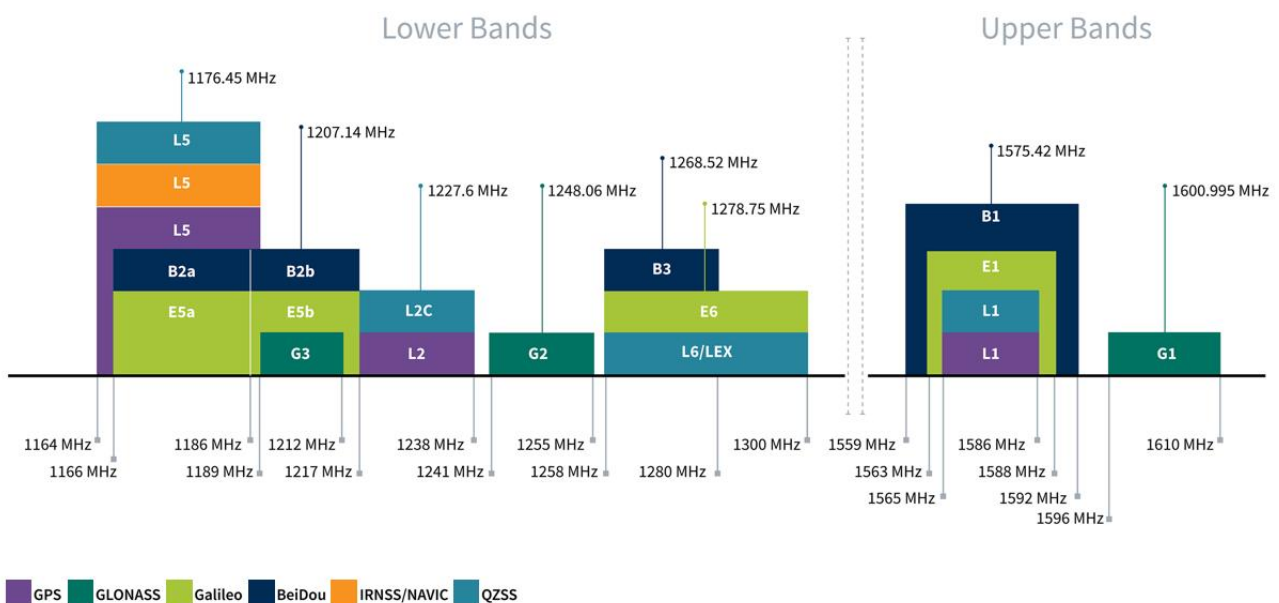

### GNSS Bands and Constellations

<b>GNSS Electrical</b>						
Frequency (MHz)	GPS L5/ Galileo E5a	GPS L2	GPS L6/ Galileo E6	BeiDou B1/ Galileo E2	GPS L1/ Galileo E1	GLONASS L1
	1176.45	1227.6	1278.8	1561	1575.42	1602
Efficiency (%)	80 Typ.	80 Typ.	70 Typ.	60 Typ.	60 Typ.	60Typ.
Average Gain (dB)	-0.7	-0.8	-1.2	-2.0	-1.8	-1.7
Peak Gain (dBi)	3.6	3.3	3.3	2.6	2.8	3.0
Return loss (dB)	< -10	< -10	< -5	< -10	< -10	< -10
Group Delay	1	1	1.2	3	3	3
PCO (cm)	1.46	2.44	2.3	0.34	0.34	0.40
PCV (cm)	9.8	10.3	9.5	7	7.2	7.2
Polarization	Linear					
Impedance	50Ω					
<b>Mechanical</b>						
Dimensions (mm)	10 x 3.2 x 1.5 mm					
Weight (g)	0.17 g					
<b>Environmental</b>						
Operating Temperature	-40°C to 85°C					
Storage Temperature	-25°C to 85°C					
Relative Humidity	20°C to 70°C					

### 3. Antenna Characteristics

#### 3.1 Return Loss

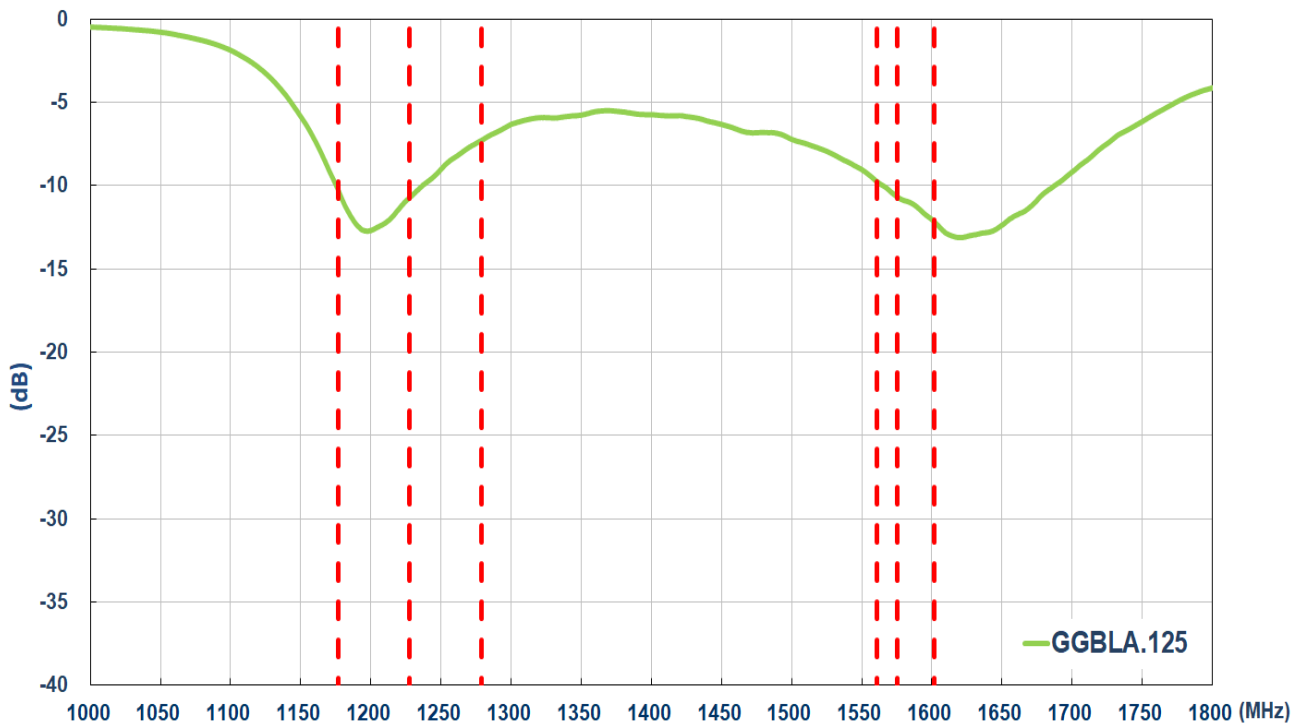

#### 3.2 Efficiency

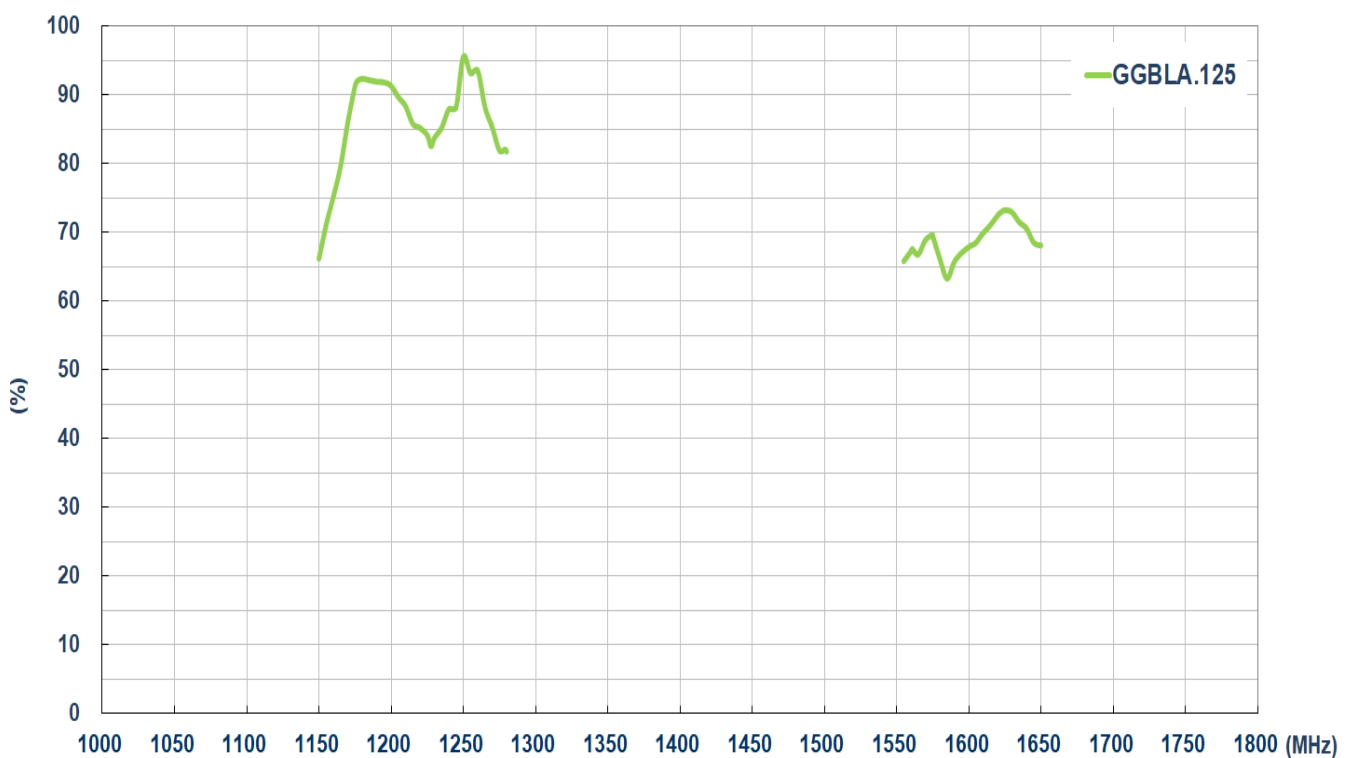

### 3.3 Average Gain

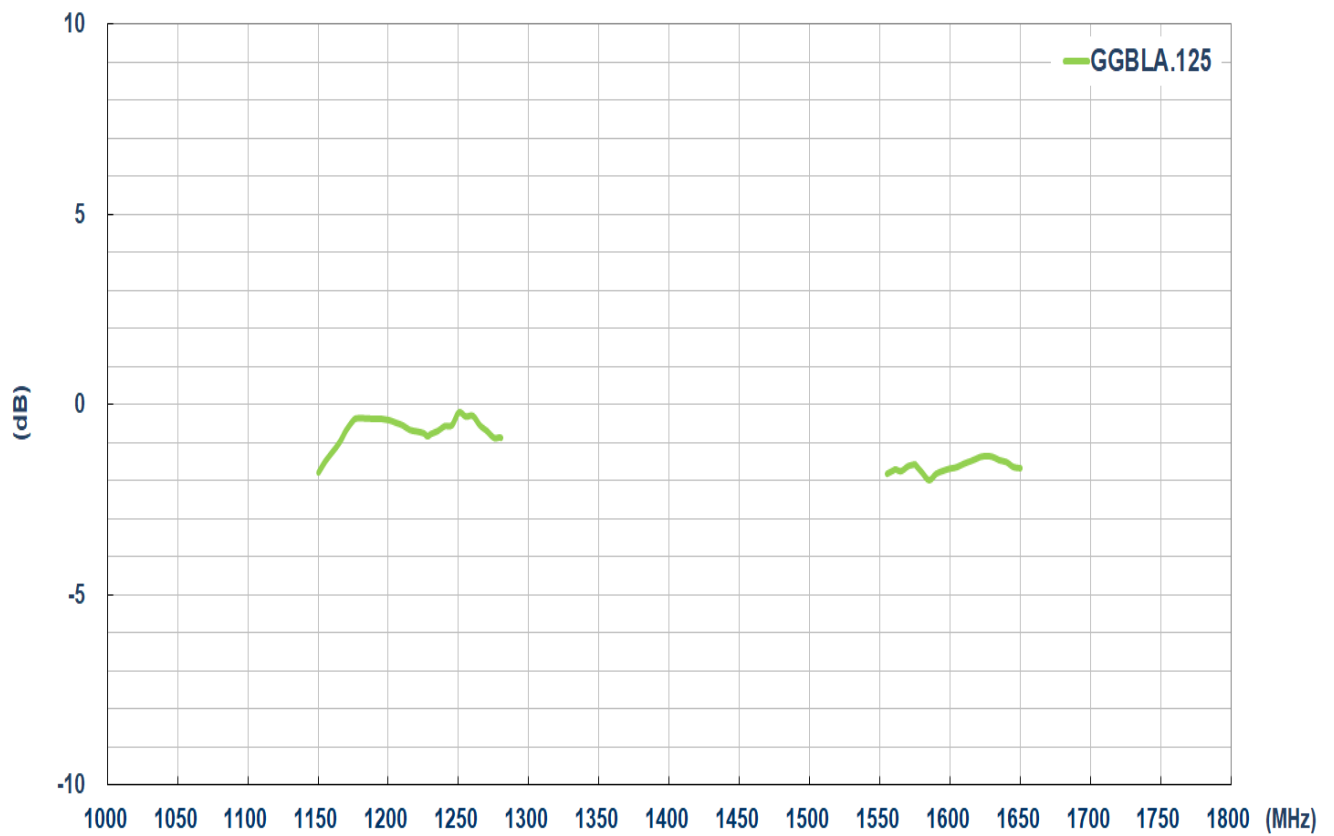

### 3.4 Peak Gain

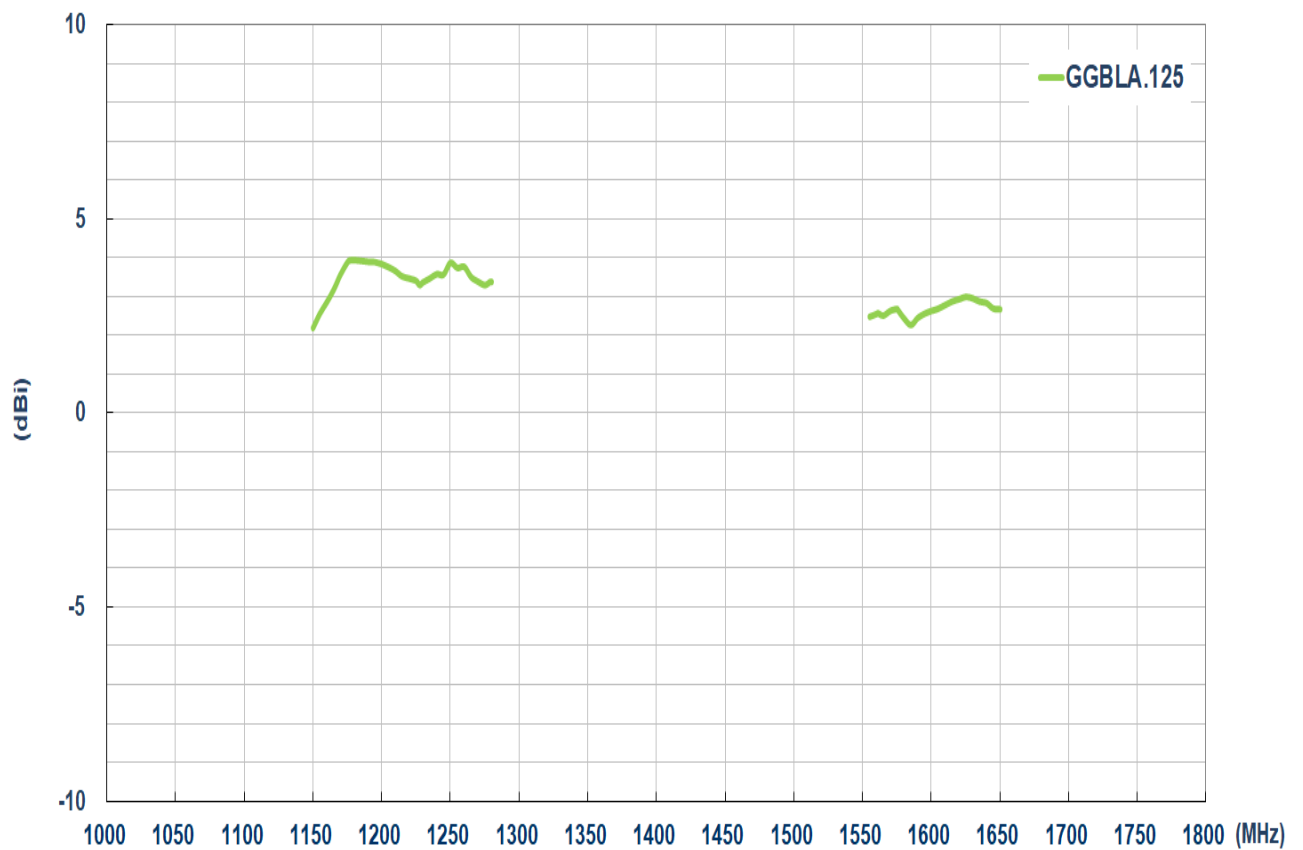

## 4. 2D Radiation Patterns

### 4.1 Test Setup – on 80\*40mm Evaluation Board

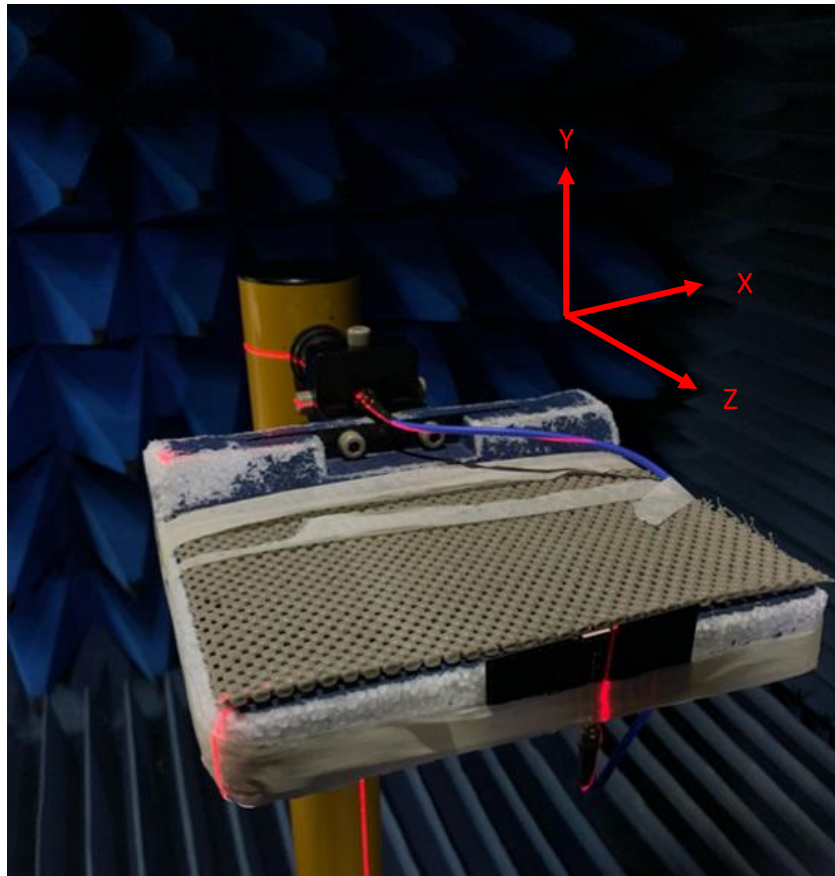



## 4.2 2D Plots

### XY Plane

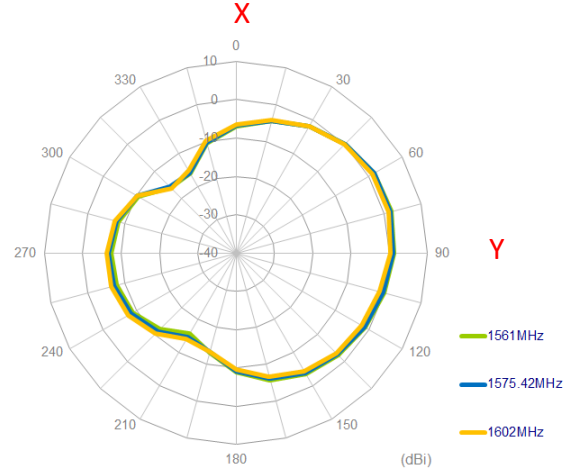
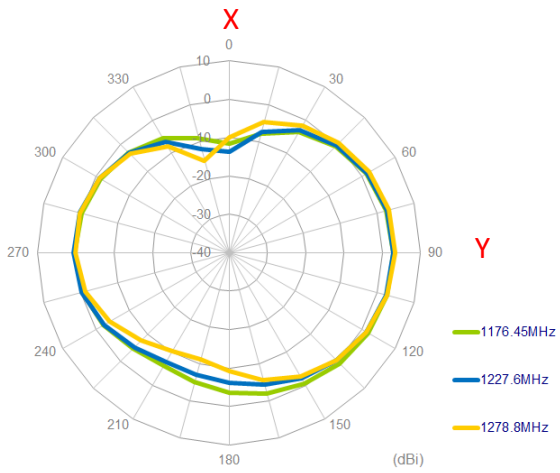

### XZ Plane

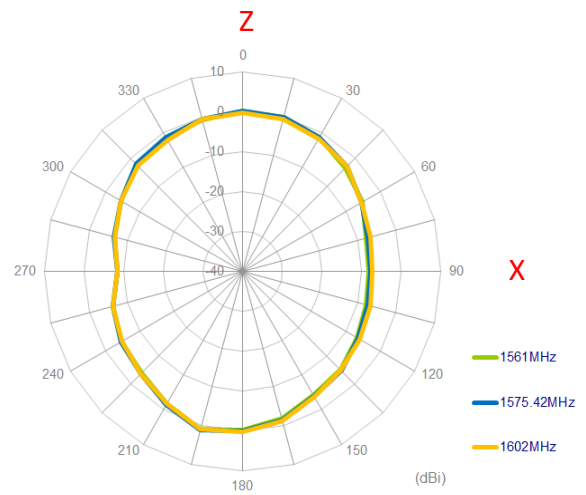
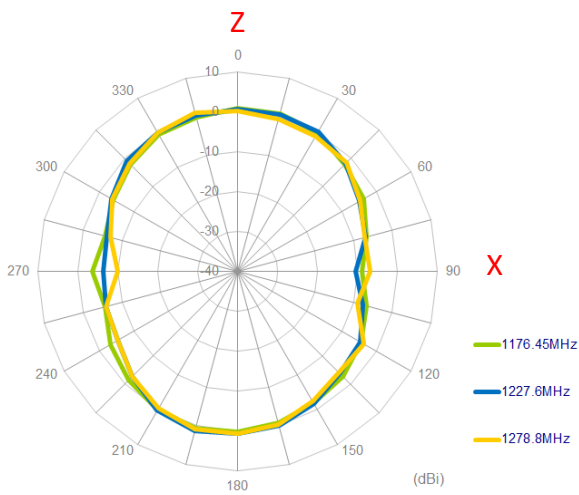

### YZ Plane

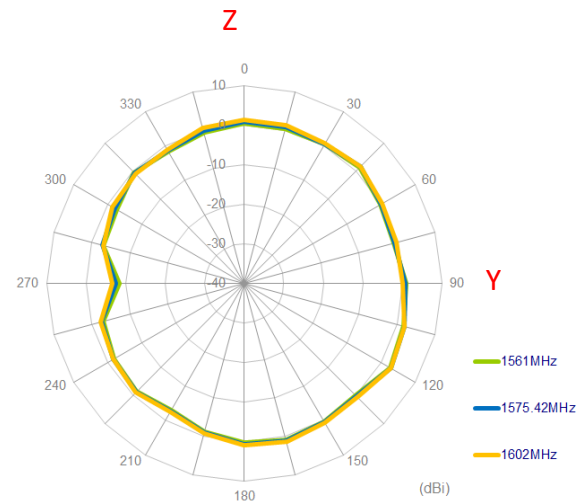
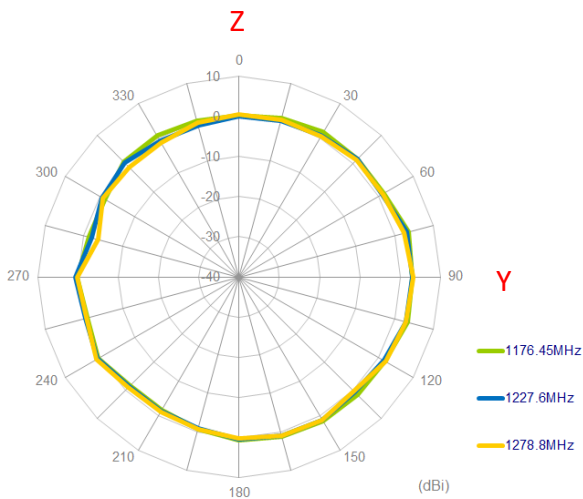

# 5. 3D Radiation Patterns

## 5.1 GGBLA.125.A

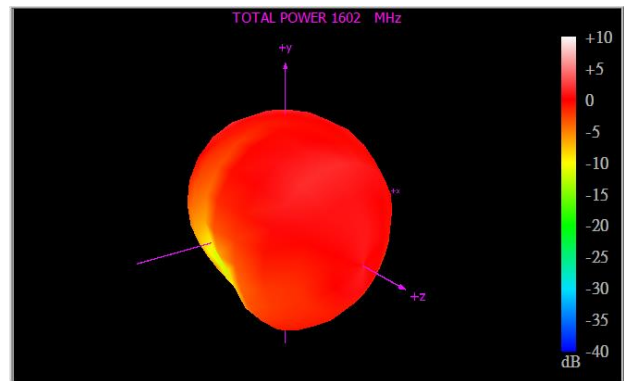
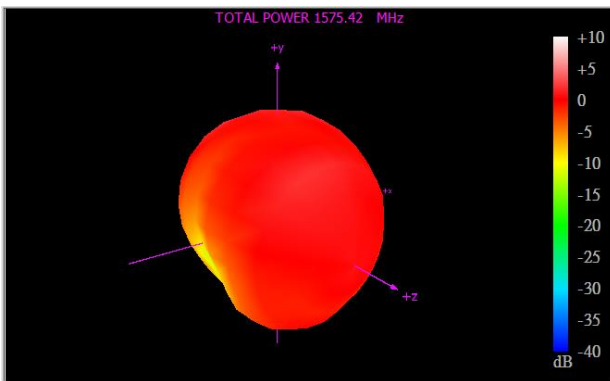
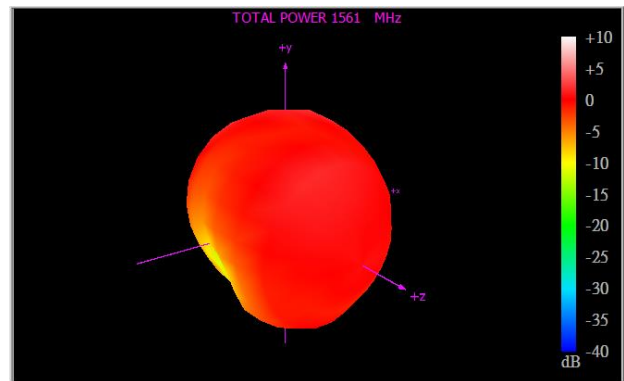
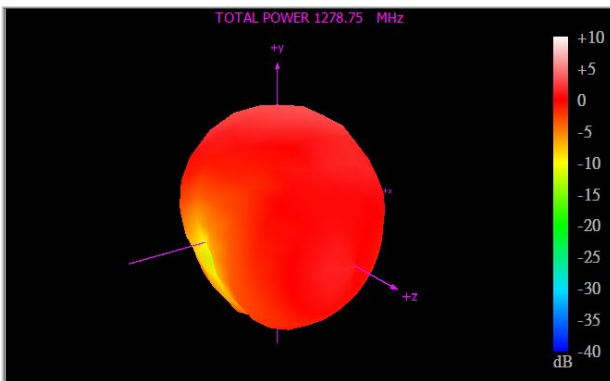
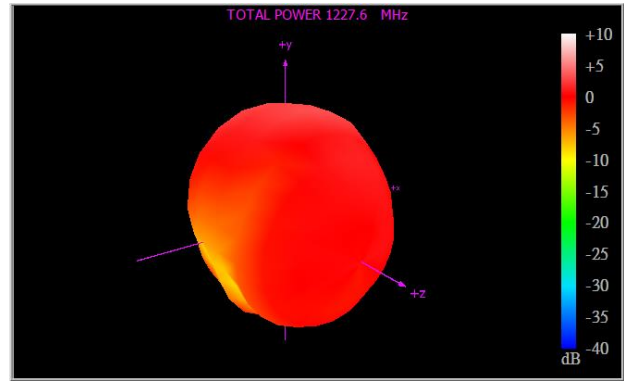
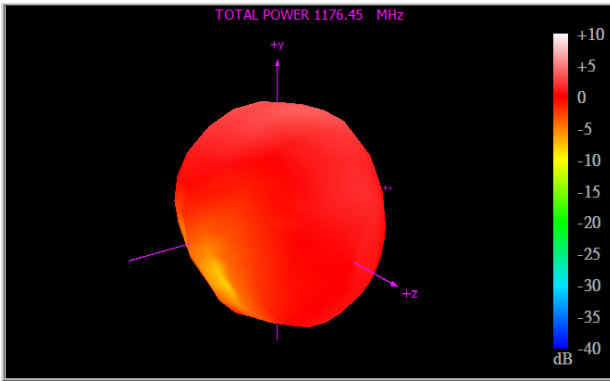

## 6. Field Test Results

### 6.1 Rooftop test

In this section Taoglas will present the field test result for GGBLA.125A antenna. The test was performed when the antenna was mounted on a static rooftop test set up in an open sky environment for at least **6 hours**.

Taoglas will show the field test results using the following receiver:

#### 1. U-blox ZED-F9P

##### Receiver features:

- Multi-band GNSS: 184-channel GPS L1C/A L2C, GLONASS: L1OF L2OF, Galileo: E1B/C E5b, BeiDou: B1I B2I, QZSS: L1C/A L2C
- Multi-band RTK with fast convergence times and reliable performance
- Nav. update rate RTK up to 20 Hz
- Position accuracy = RTK 0.01 m + 1 ppm CEP

Positioning Accuracy Table (2D Accuracy)					
Test Condition	Correction Service	CEP (50%)	DRMS (68%)	2DRMS (95-98.2%)	TTF (sec)
EVB	RTK DISABLED	106.72 cm	134.17 cm	268.34 cm	32
	RTL ENABLED	10.59 cm	12.88 cm	25.75 cm	32

RTK Availability

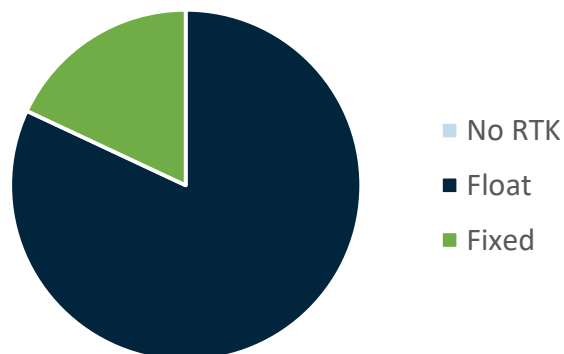

## 7. Mechanical Drawing (Units: mm)

### 7.1 Antenna Drawing

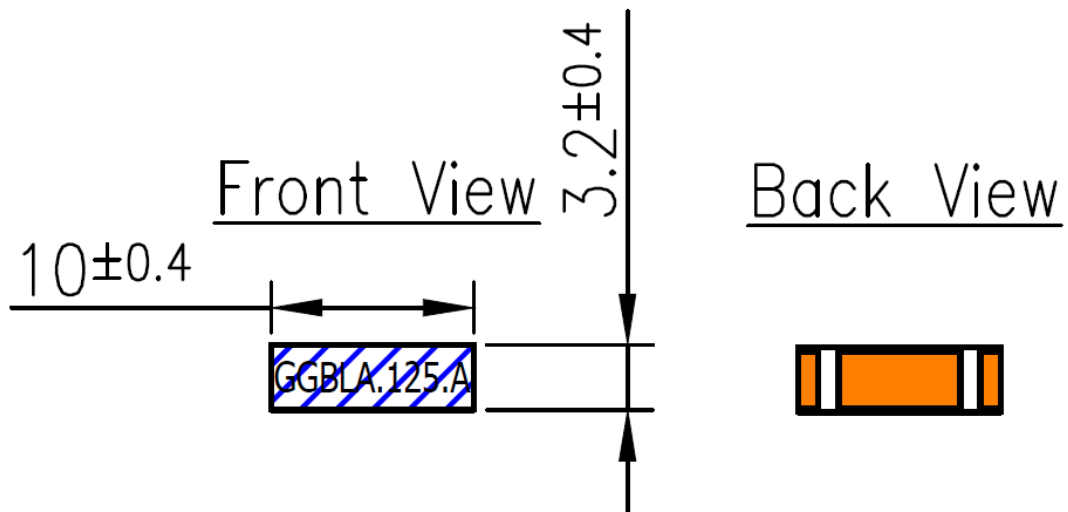

### 7.2 Antenna Dimensions

#### Bottom Pin and View Definition – Back View

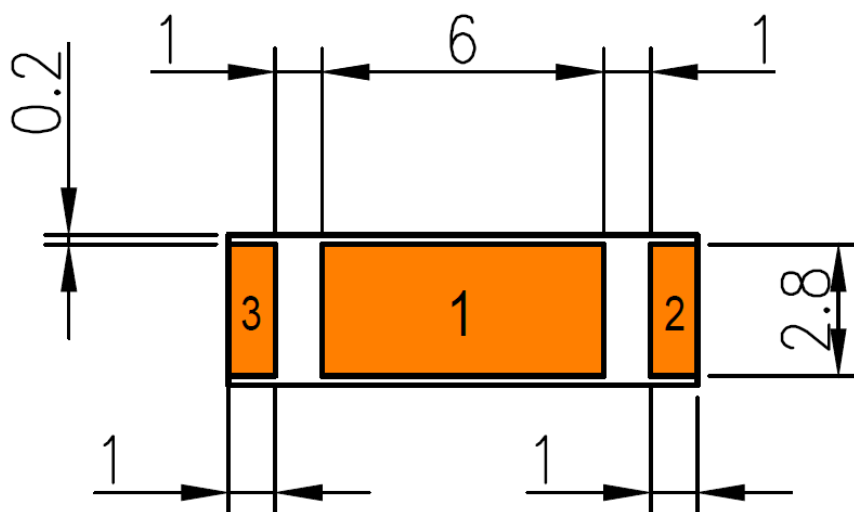

Pin	Description
1	Feed (50 ohm)
2.3	Ground Feed

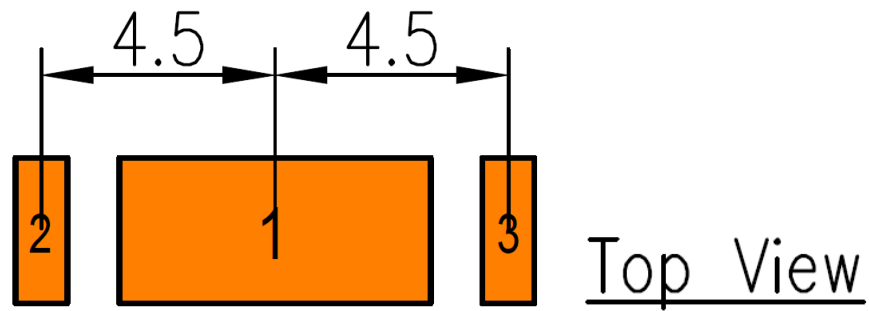

Antenna Footprint - Top View

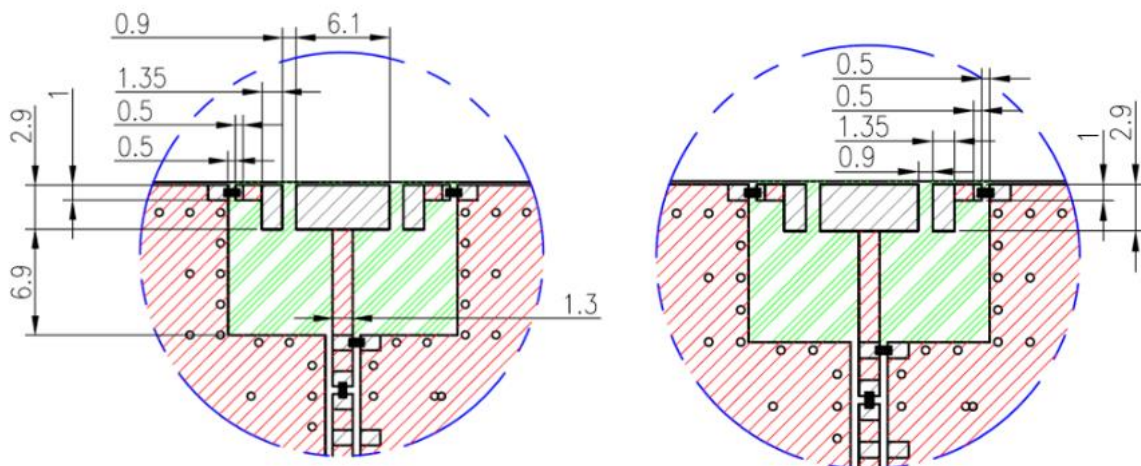

Host PCB Layout – Top View



Top View

Copper area  Ground Clearance Area   
 Soldered area 

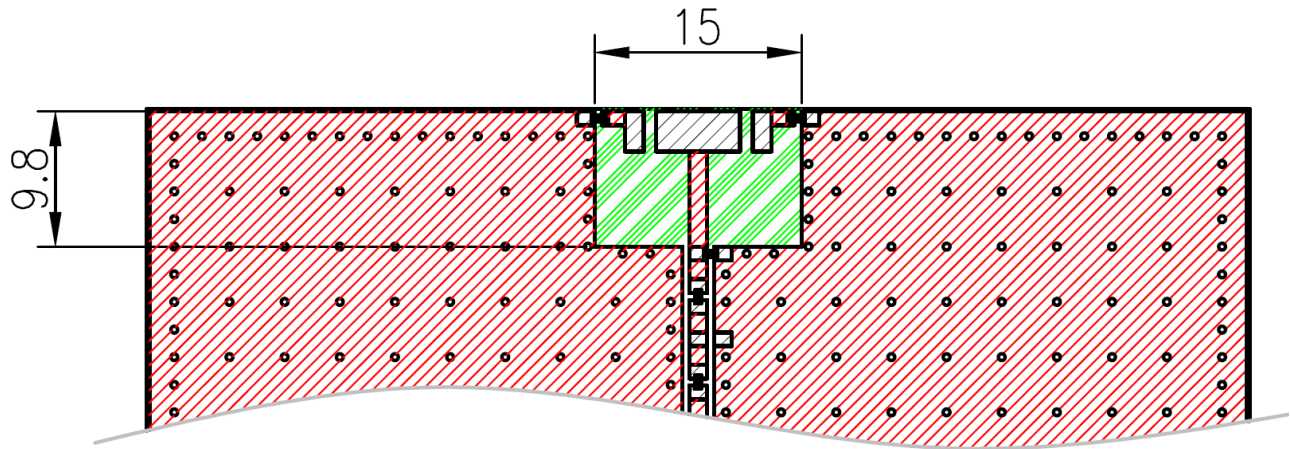

Clearance Area

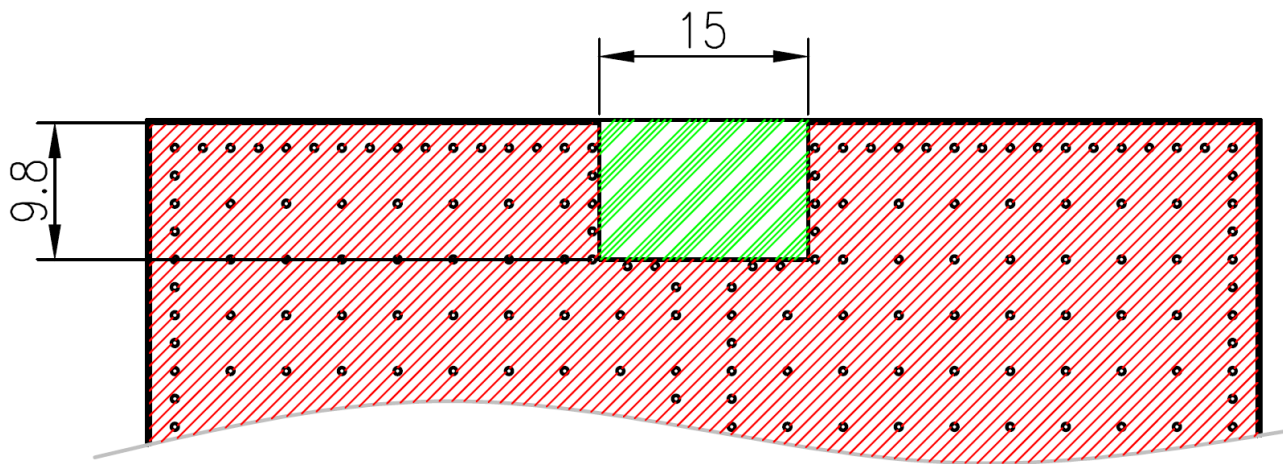

Top View



Bottom View

Copper area  Ground Clearance Area   
 Soldered area 

Evaluation Board

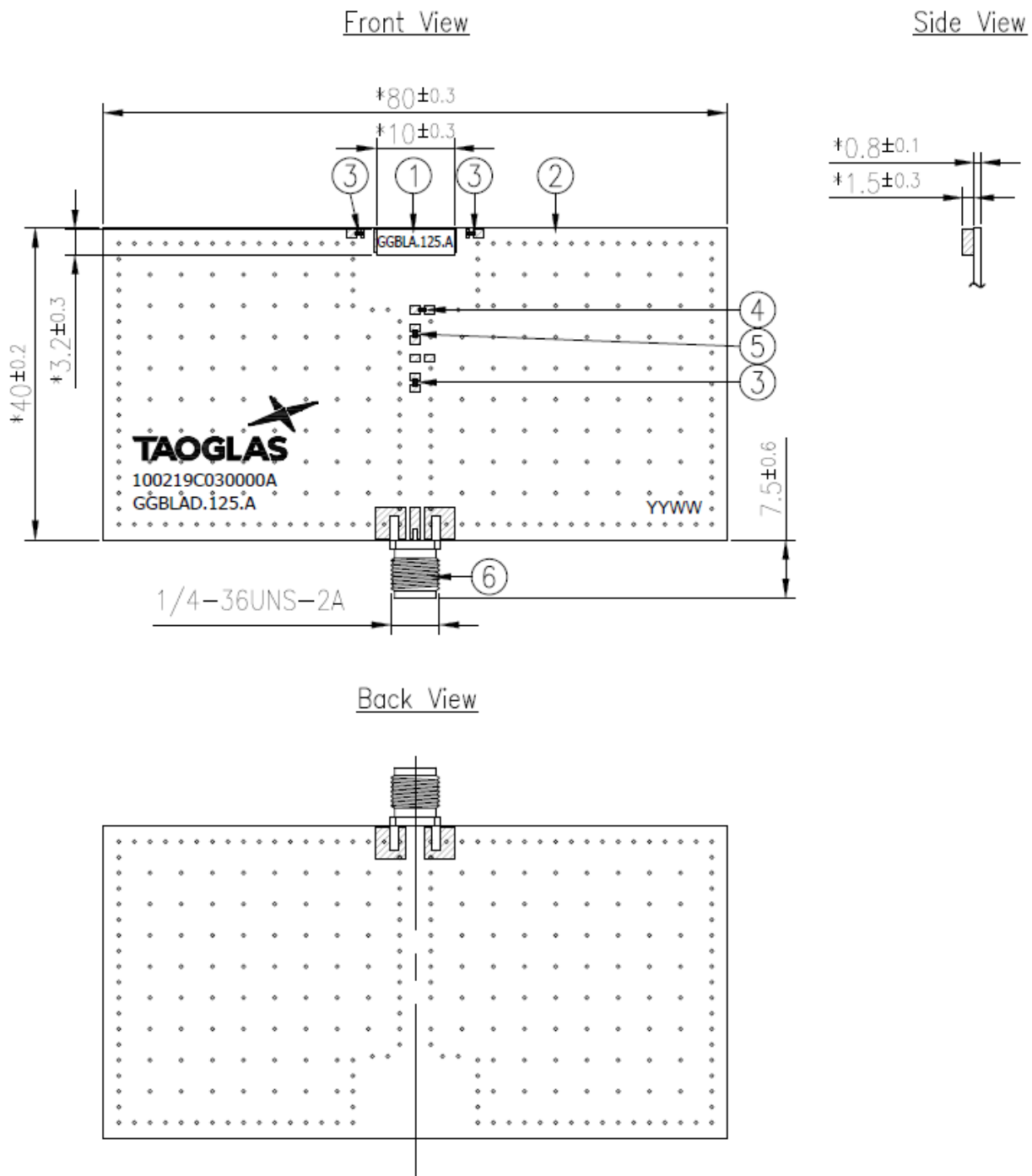

	Name
1	GGBLA.125.A Antenna
2	GGBLAD.125.A EVB PCB
3	0 hm Resistor (0402)
4	1.2pF Capacitor (0402)
5	3.9pF Capacitor (0402)
6	SMA(F) ST PCB

## Evaluation Board Matching Circuit

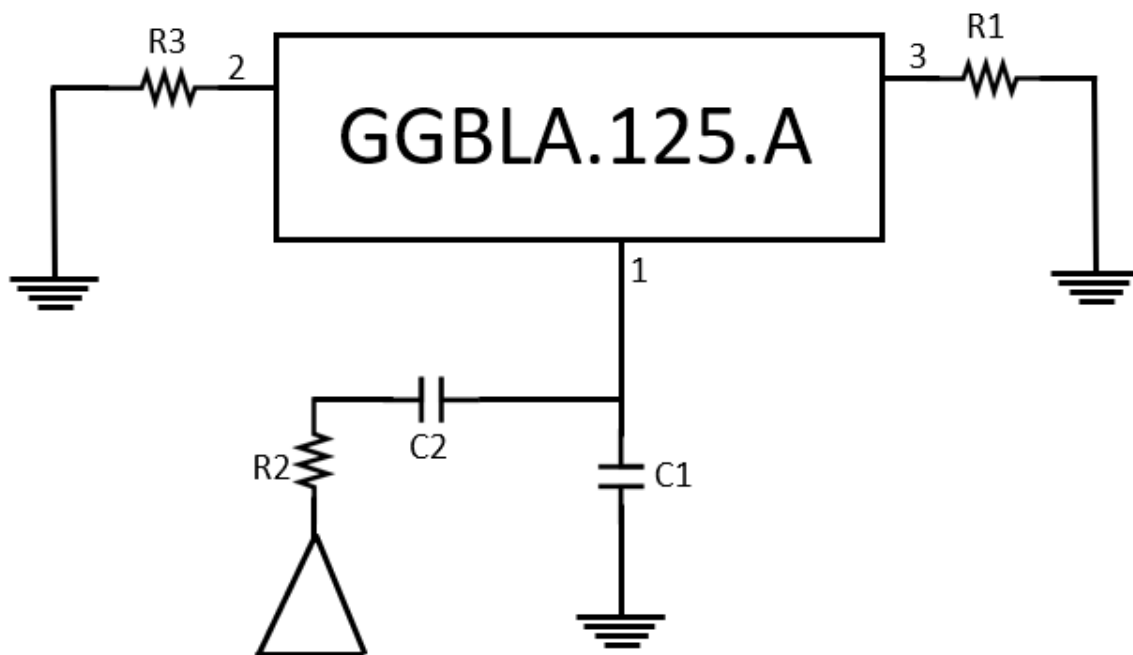

Matching Circuit	
Component	Component Values
R1	0 ohm
R2	0 ohm
R3	0 ohm
C1	1.2 pF
C2	3.9 pF



## 8. Packaging

2000pcs GGBLA.125.A per Tape & Reel  
 Dimensions -  $\varnothing 330 \times 28.4$   
 Weight - 1Kg

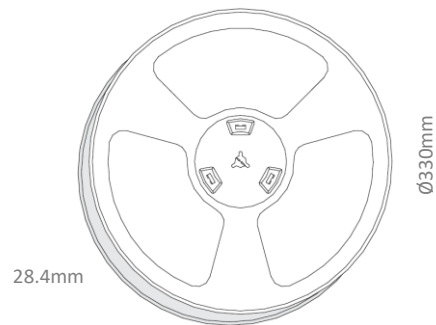

2000pcs GGBLA.125.A per carton  
 Dimensions - 350\*340\*47mm  
 Weight - 1.2Kg

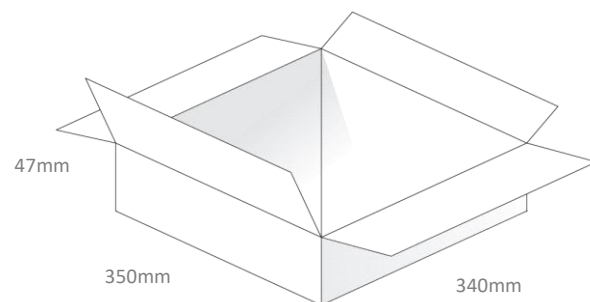

10000pcs GGBLA.125.A per carton  
 Dimensions - 360\*370\*275mm  
 Weight - 6.8Kg

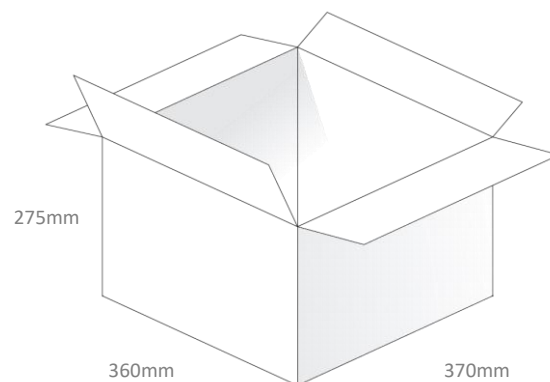

Pallet Dimensions:  
 1100\*1100\*1300mm  
 36 Cartons Per Pallet  
 9 Cartons Per Layer, 4 Layers

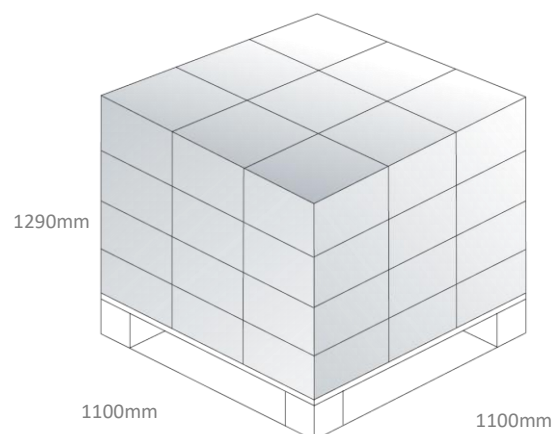

Changelog for the datasheet

**SPE-19-8-045 – GGBLA.125.A**

**Revision: D (Current Version)**

Date:	2020-06-04
Changes:	Added Field Test Results
Changes Made by:	Victor Pinazo

**Previous Revisions**

**Revision: C**

Date:	2020-03-18
Changes:	Modified RTK Table
Changes Made by:	Yu Kai Yeung

**Revision: B**

Date:	2019-12-08
Changes:	Added GNSS Frequency Matrix and RTK Data
Changes Made by:	Yu Kai Yeung

**Revision: A (Original First Release)**

Date:	2019-04-04
Notes:	Initial Specification Release
Author:	Yu Kai Yeung



**TAOGLAS**®

[www.taoglas.com](http://www.taoglas.com)

