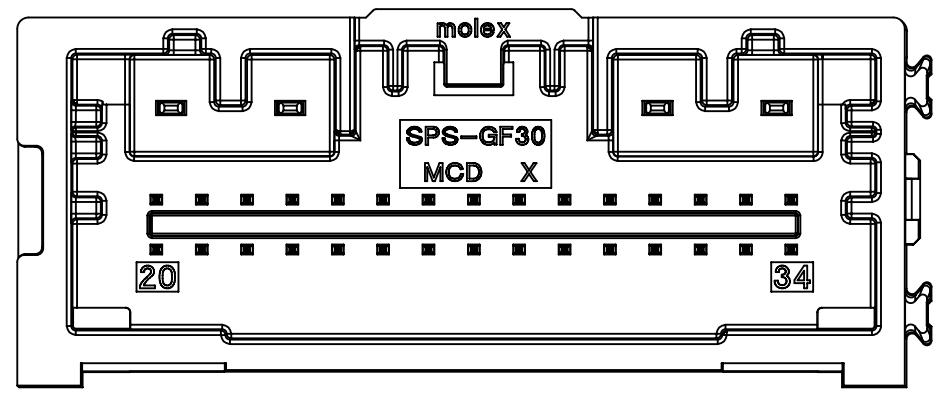
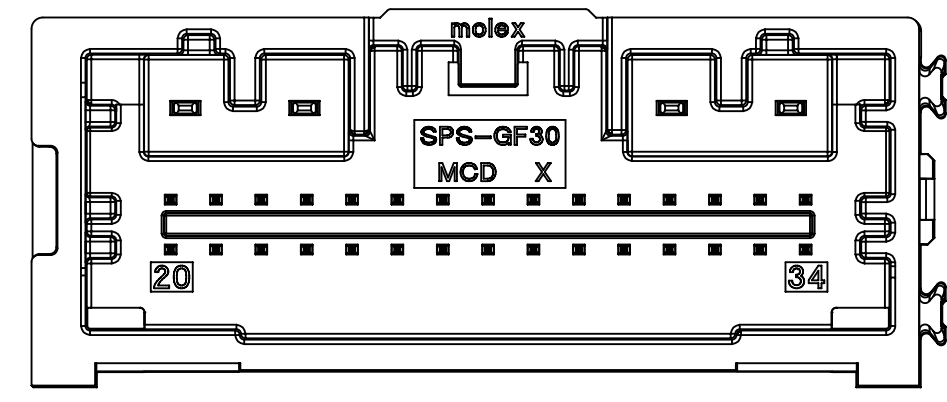

TABLE OF CONTENTS	
SHEET NO.	SHEET DESCRIPTION
2	34&38CKT POLARIZATION OPTION VIEW, HB/V0 HEADER DIFFERENCE VIEW



34CKT POLARIZATION OPTION 'A'



34CKT POLARIZATION OPTION 'B'

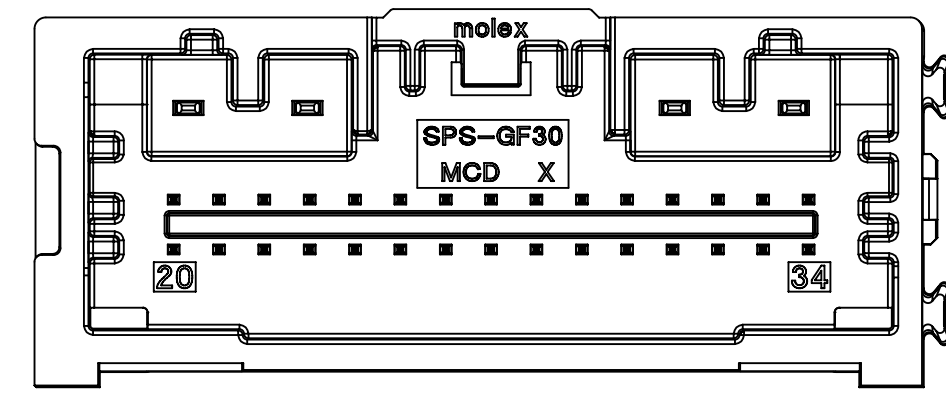

34CKT POLARIZATION OPTION 'C'

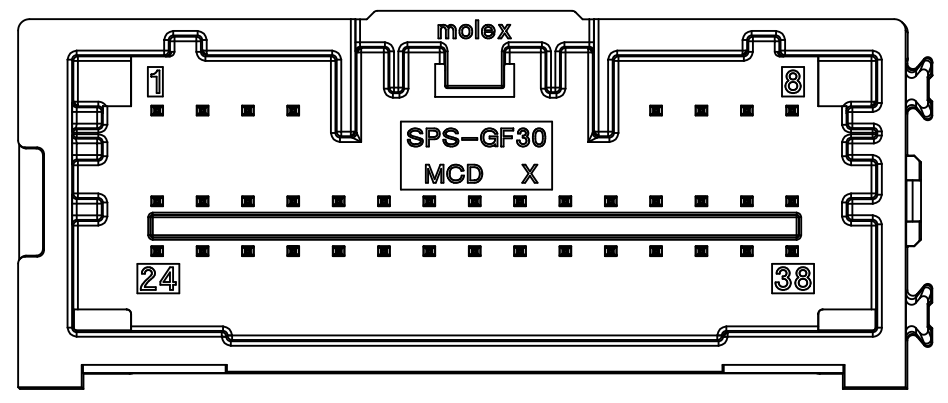

38CKT POLARIZATION OPTION 'A'

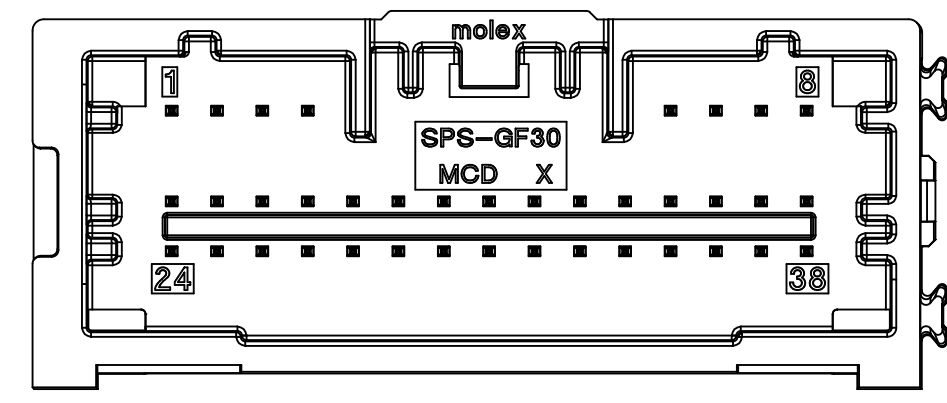

38CKT POLARIZATION OPTION 'B'

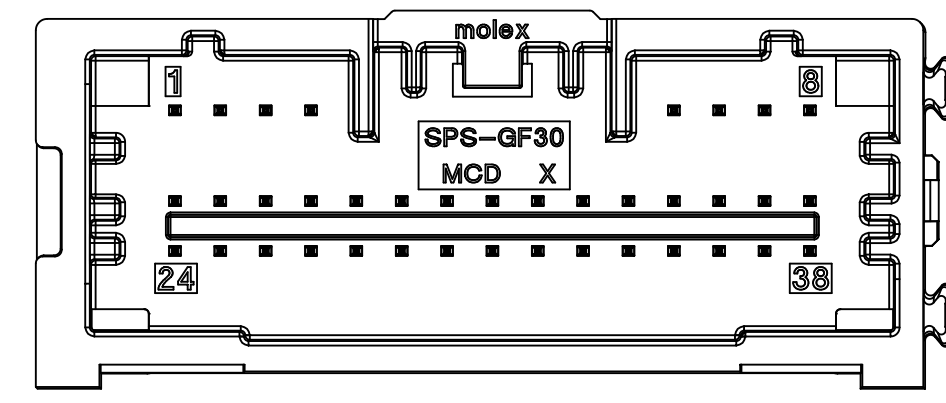

38CKT POLARIZATION OPTION 'C'

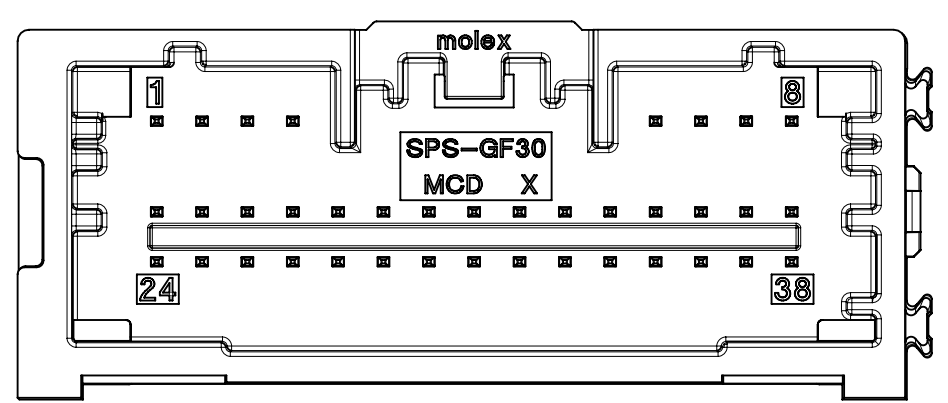

38CKT POLARIZATION OPTION 'UPDATED A'

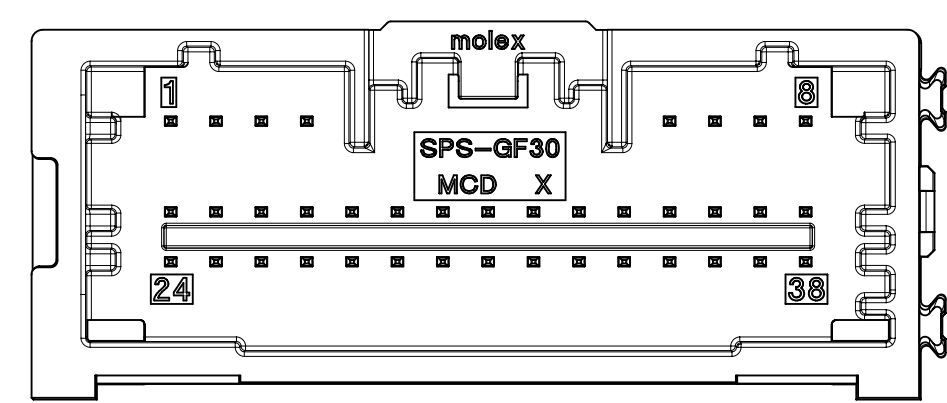

38CKT POLARIZATION OPTION 'UPDATED B'

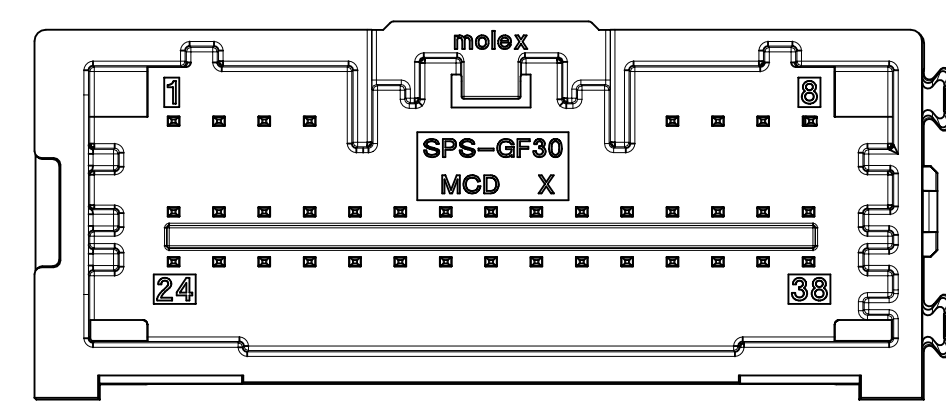

38CKT POLARIZATION OPTION 'UPDATED C'

④ HB / V0 VERSION DIFFERENCE

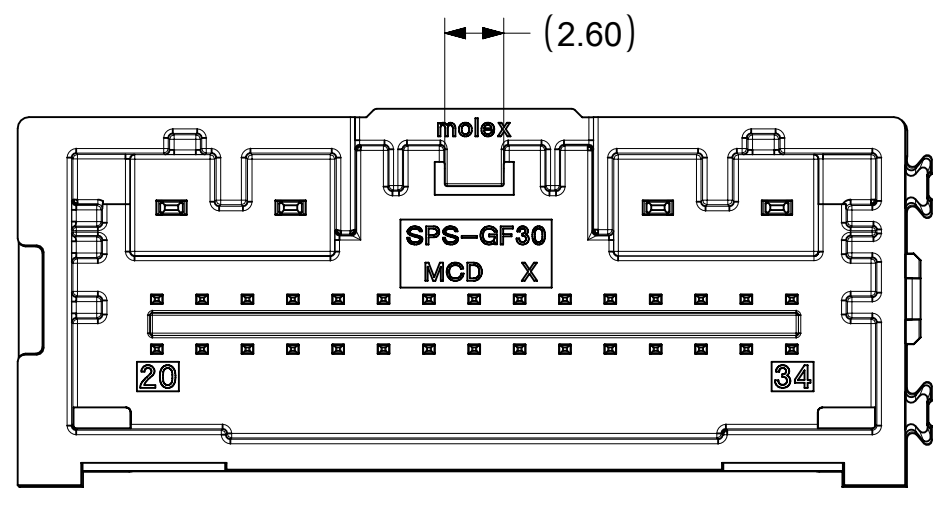

HB P/Ns: 34958XXXX
APPLIES TO ALL CKT SIZES, USE 34CKT AS SHOWN

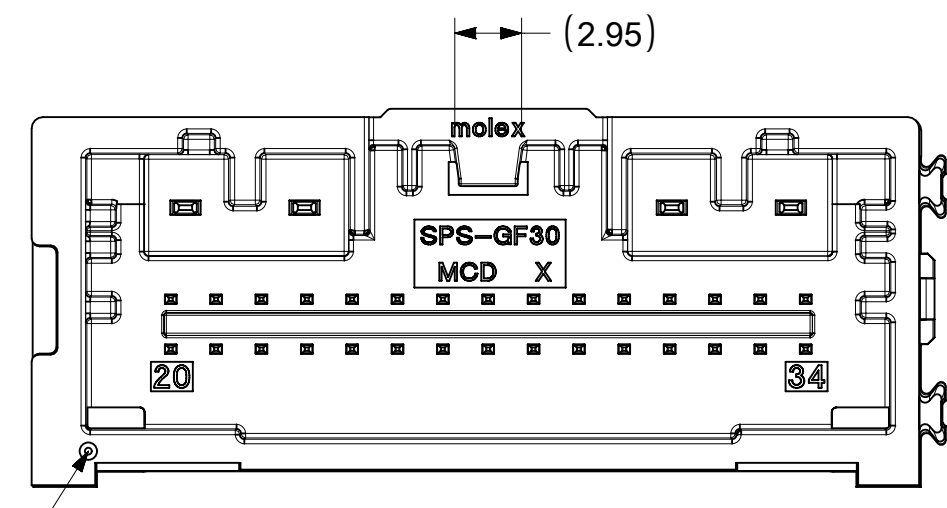

V0 P/Ns: 213382XXXX
APPLIES TO ALL CKT SIZES, USE 34CKT AS SHOWN

DEPRESSION FEATURE ADDED TO V0 PART TO DISTINGUISH FROM HB PART

PENDING APPROVAL

FUNCTIONAL SYMBOLS FA = 0 FC = 0 FP = 0	THIS DRAWING CONTAINS INFORMATION THAT IS PROPRIETARY TO MOLEX ELECTRONIC TECHNOLOGIES, LLC AND SHOULD NOT BE USED WITHOUT WRITTEN PERMISSION		CURRENT REV DESC:		
	DIMENSION UNITS	SCALE			
	mm	3:1			PRODUCT CUSTOMER DRAWING
	GENERAL TOLERANCES (UNLESS SPECIFIED)				DOCUMENT NUMBER
	ANGULAR TOL ± °				DOC TYPE
	4 PLACES ±		EC NO: 633345		DOC PART
	3 PLACES ±		DRWN: SWU31		REVISION
	2 PLACES ±		CHK'D:		SD-34958-300
	1 PLACE ±		APPR:		PSD
	0 PLACES ±		INITIAL REVISION:		001
	DRAFT WHERE APPLICABLE MUST REMAIN WITHIN DIMENSIONS		DRWN: JFISCHER01		D
	THIRD ANGLE PROJECTION		APPR: RBAUMAN		
	D-DRAWING		SERIES		
	D-SIZE		34958		
	DRAWING		MATERIAL NUMBER		
	SERIES		CUSTOMER		
	34958		GENERAL MARKET		
			SHEET NUMBER		
			2 OF 3		

DOCUMENT STATUS	RQ	RELEASE DATE

TABLE OF CONTENTS	
SHEET NO.	SHEET DESCRIPTION
3	DETAIL DIMENSION VIEW REFERENCE PCB LAYOUT

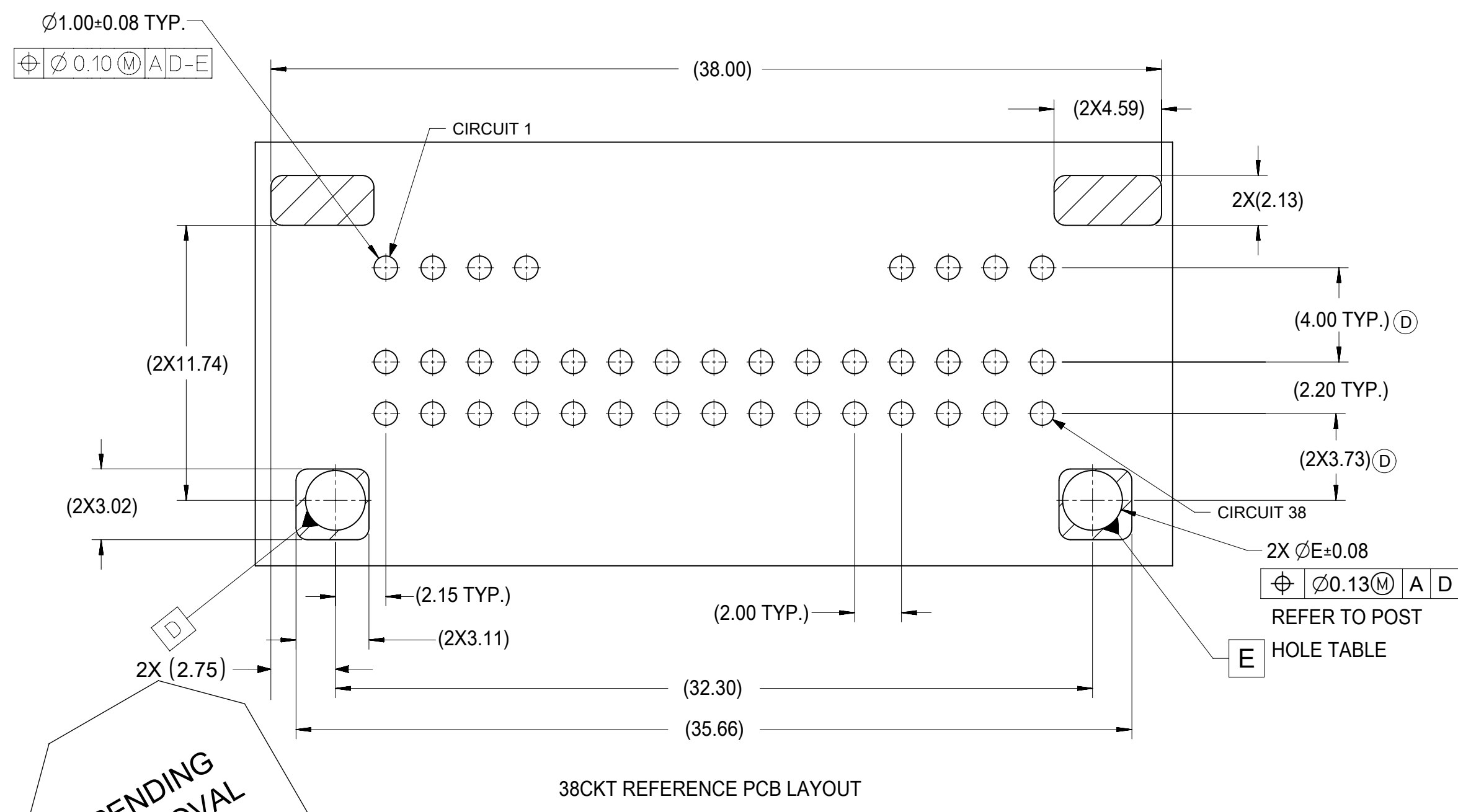
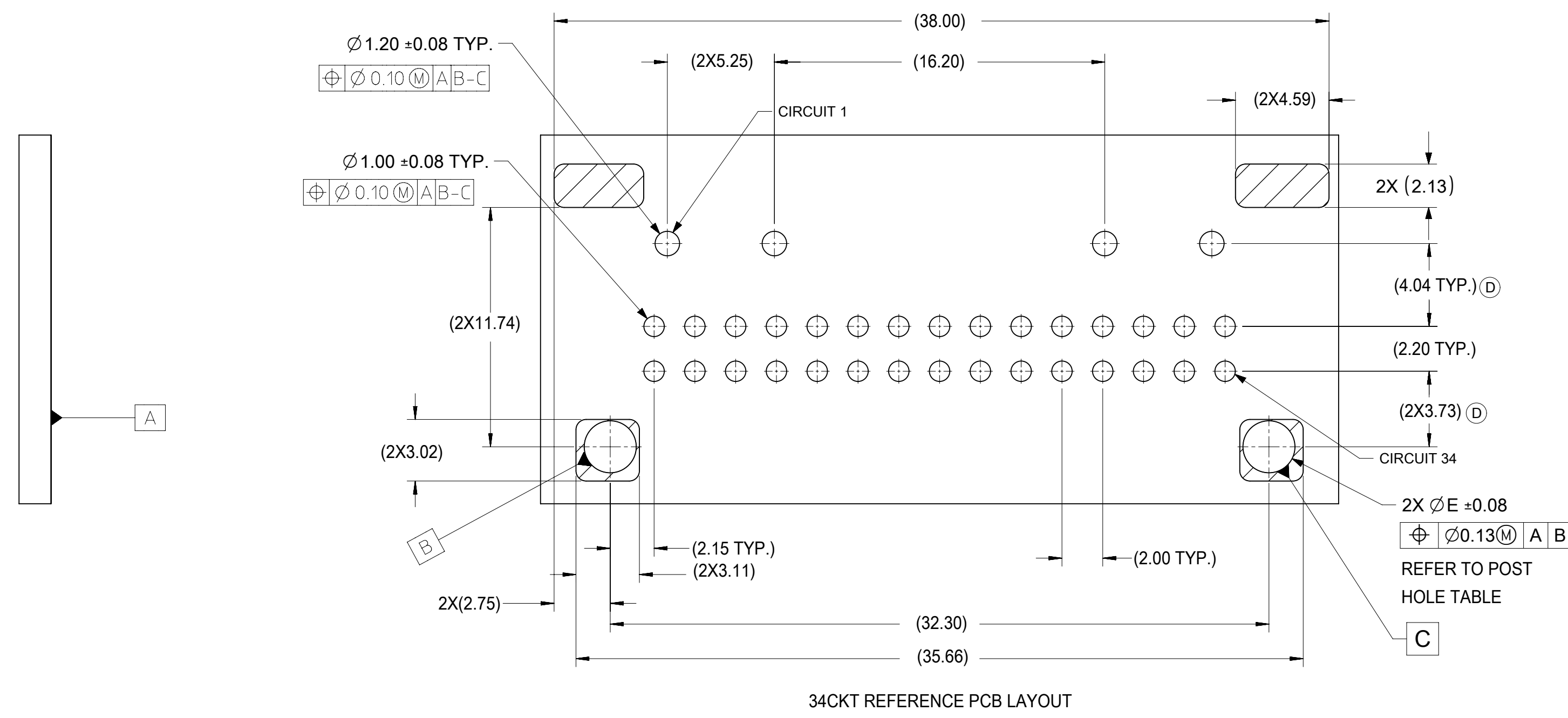
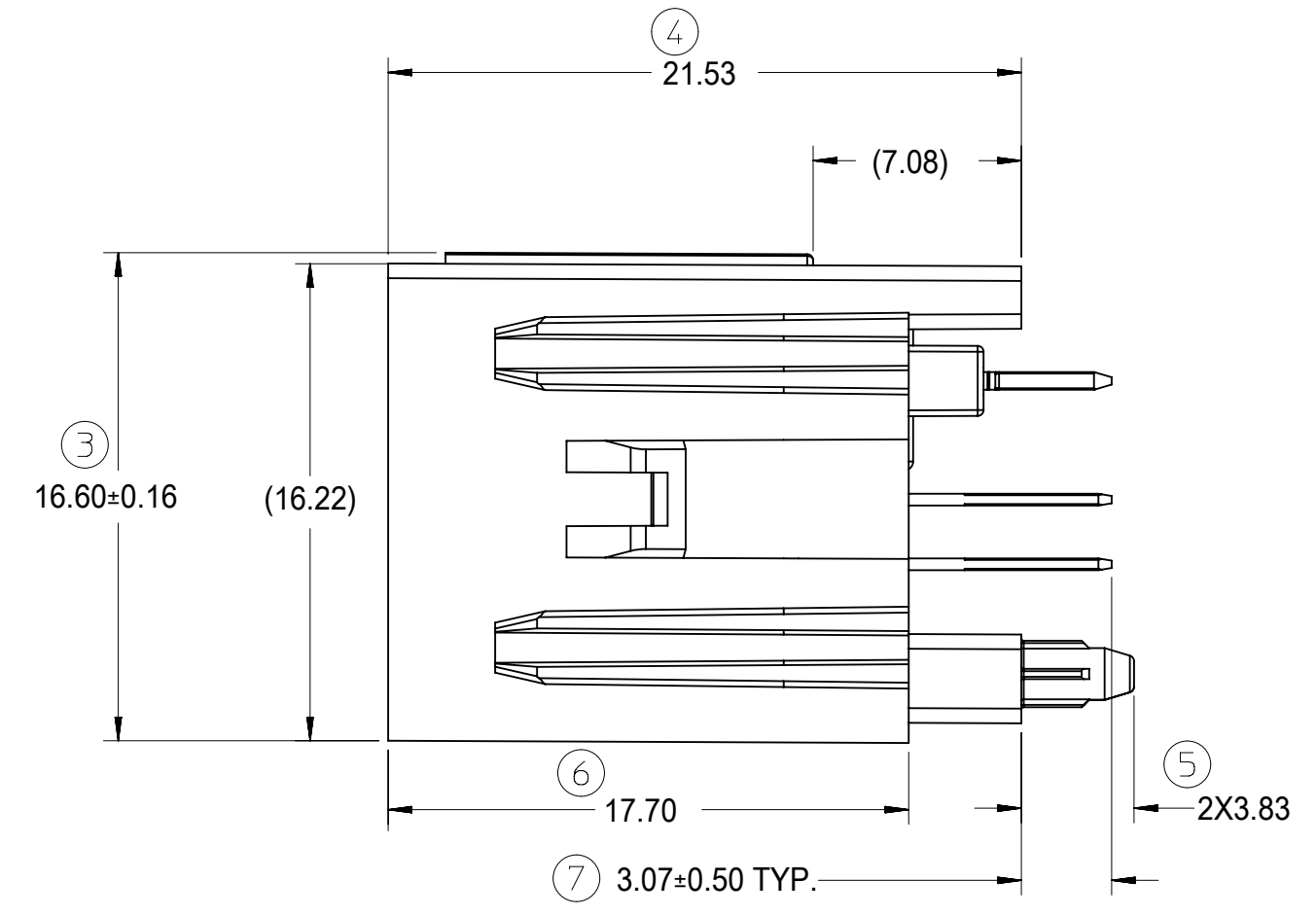
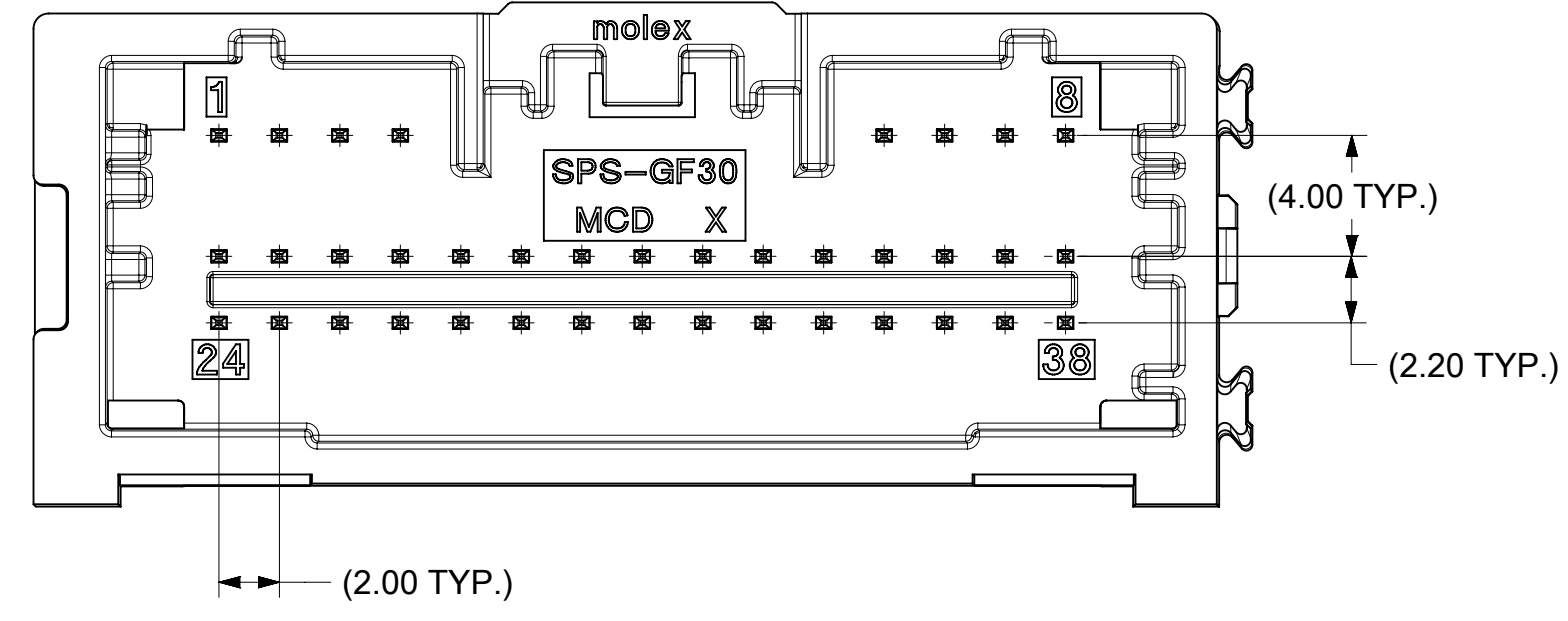
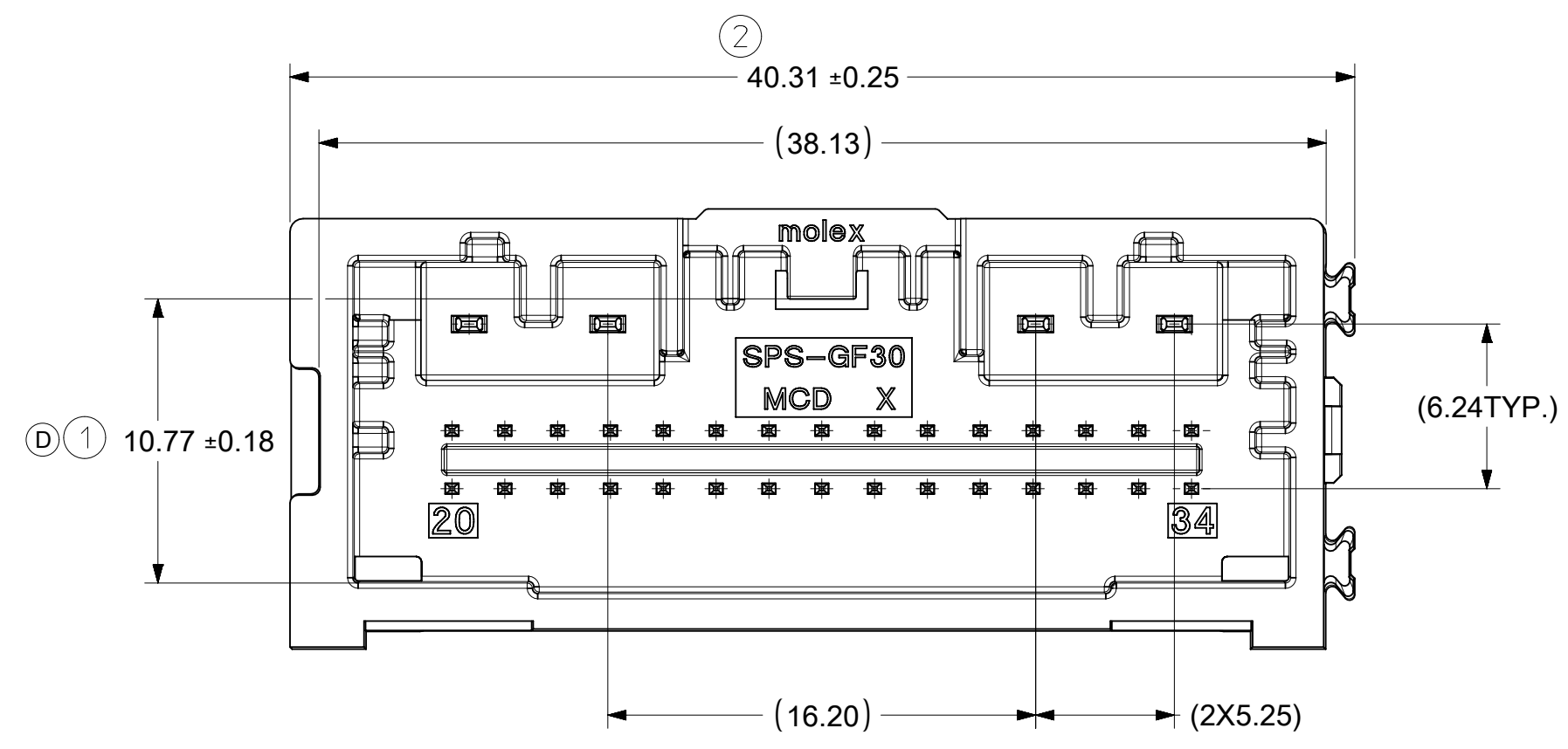

POST HOLE TABLE:

FOR DIM E :	
PRESS FIT :	2.15
DROP IN :	2.55

PENDING APPROVAL

FUNCTIONAL SYMBOLS FA = 0 FC = 0 FP = 0	DIMENSION UNITS mm	SCALE 4:1	CURRENT REV DESC:		
			GENERAL TOLERANCES (UNLESS SPECIFIED)		
DIVISIONAL SYMBOLS	ANGULAR TOL ± °		EC NO: 633345		
	4 PLACES ±		DRWN: SWU31		
3 PLACES ±		CHK'D:			
2 PLACES ±		APPR:			
1 PLACE ±		INITIAL REVISION:			
0 PLACES ±		DRWN: JFISCHER01			
DRAFT WHERE APPLICABLE MUST REMAIN WITHIN DIMENSIONS		THIRD ANGLE PROJECTION		2013/12/05	
		DRAWING		2014/02/19	
		D-SIZE		SERIES	
		34958		MATERIAL NUMBER	
		GENERAL MARKET		CUSTOMER	
		3 OF 3		SHEET NUMBER	

molex

34 & 38 CKT MINI50
VERTICAL HEADER ASSEMBLY SALES DRAWING

PRODUCT CUSTOMER DRAWING

DOCUMENT NUMBER	DOC TYPE	DOC PART	REVISION
SD-34958-300	PSD	001	D

DOCUMENT STATUS	RQ	RELEASE DATE
-----------------	----	--------------