



# DC Pass Power Splitter/Combiner 750 – 2,000 MHz

## Data Sheet

ED2-0012-01

### FEATURES

- Low Insertion loss, 0.2 dB typical
- Frequency range of 750 to 2000 MHz
- Isolation of 15 to 20 dB typical
- Excellent input VSWR, 1.22:1 typical
- Excellent output VSWR, 1.12:1 typical
- Characteristic impedance: 50Ω
- -55°C to +100°C
- SMA connectors
- Up to 5W power input
- Customizable to other frequencies and bandwidths

### APPLICATIONS

- 5G Radio
- Radar
- Cellular
- Instrumentation
- Communications Systems
- VSAT

### GENERAL DESCRIPTION

The ED2 2-way coaxial power splitter or combiner is a SMA connectorized solution for your RF subsystem needs. Designed to operate over a frequency range of 750 to 2,000 MHz as well as passing a DC signal between ports. Contact ED2 for customizing the frequency range to fit your unique requirements.

Isometric View

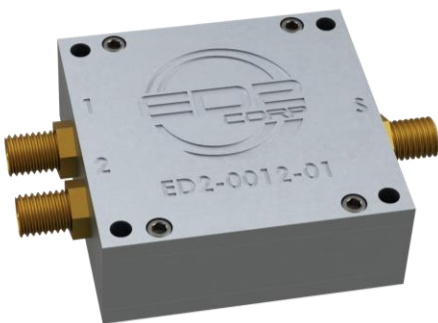

### FUNCTIONAL BLOCK DIAGRAM

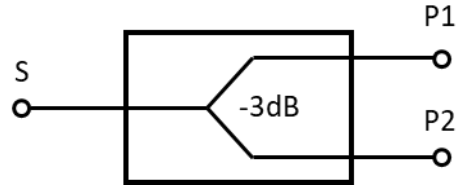

Power Divider Typical Insertion Loss

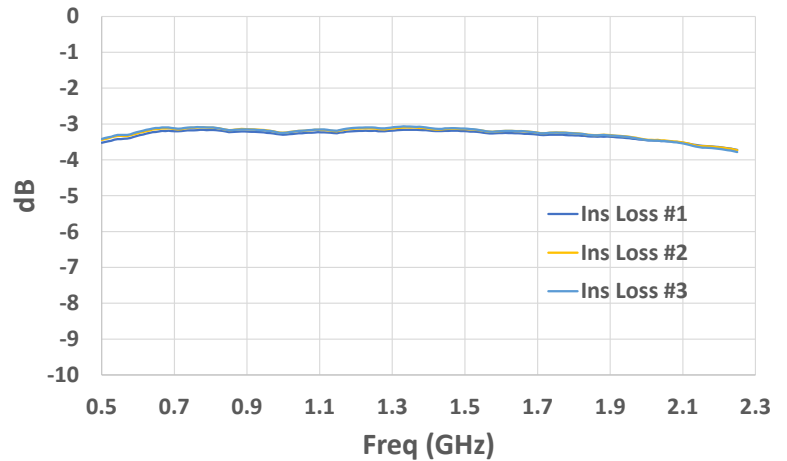

Parameter	Frequency Range (MHz)	Typ.	Max
Total Loss (dB) <sup>1</sup>	750 – 2,000	3.2	3.6
Input VSWR		1.2	1.6
Output VSWR		1.12	1.35
Input Power (W)			5
Internal Dissipation (W)			0.725
DC Current (mA)	400 Ea. Port		800
Size (L x W x H)	1.8 x 1.75 x 0.66 in 45.72 x 44.45 x 16.76 mm		

1. Total Loss = Insertion Loss + 3 dB Splitter Loss

Rev. -

Document Feedback

Information furnished by ED2 is believed to be accurate and reliable. However, no responsibility is assumed by ED2 for its use, nor for any infringements of patents or other rights of third parties that may result from its use. Specification subject to change without notice. No license is granted by implications or otherwise under any patent or patent rights of ED2. Trademarks and registered trademarks are the property of their respective owners

7636 N. Oracle Road, Tucson, Arizona 85704, U.S.A  
 Tel: 1-520-341-8310 ©2020 ED2, All Rights reserved  
 Technical Support [www.ed2corp.com](http://www.ed2corp.com)



# DC Pass Power Splitter/Combiner 750 – 2,000 MHz

Data Sheet

ED2-0012-01

## Typical Performance Data:

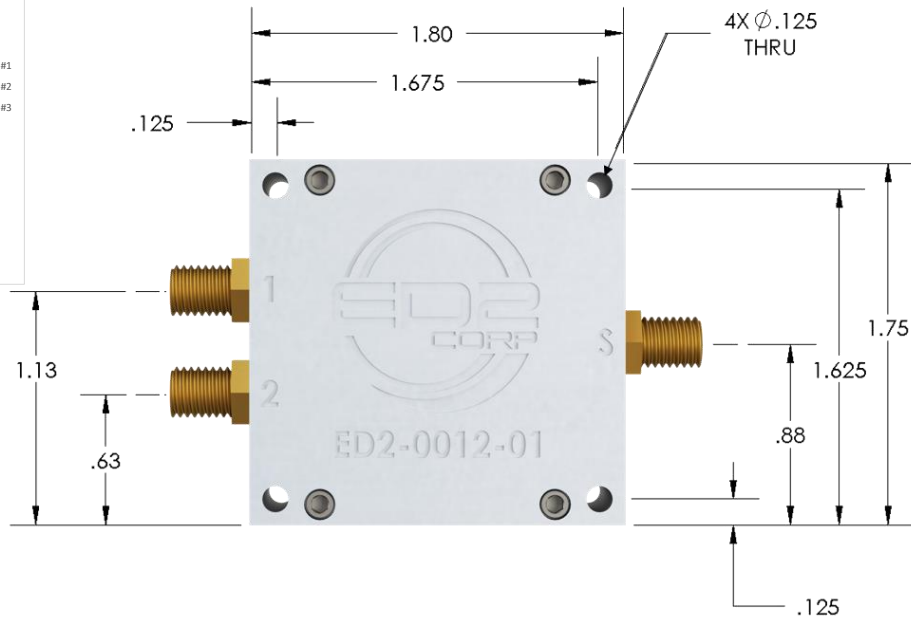
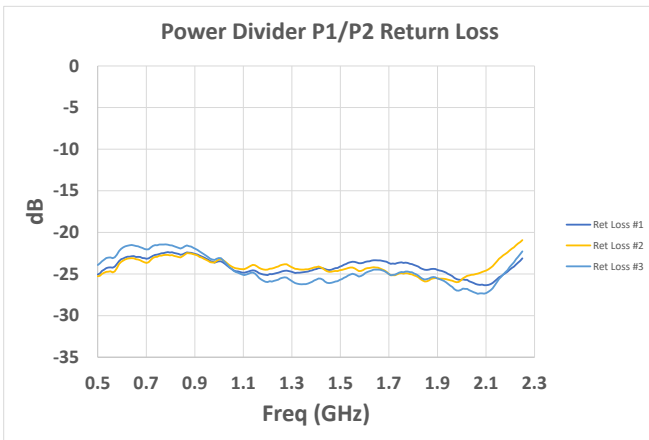
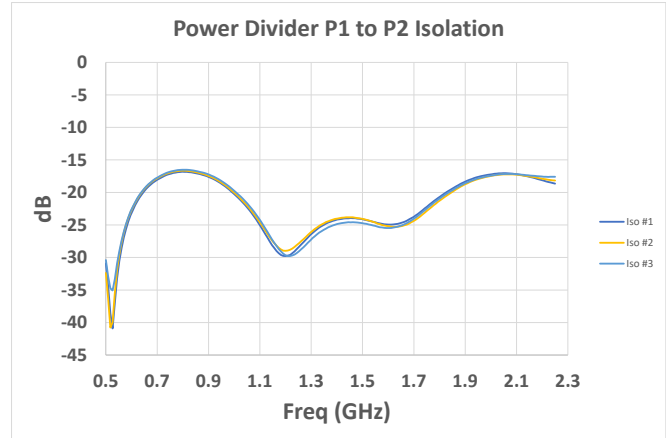
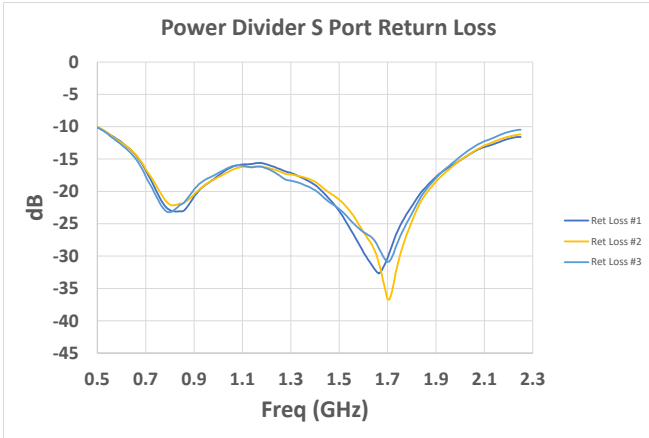

PAGE 2